

[home](#)

THE NAVAL BALANCE 1960

Navies of the world

01/01/1960

1. USA - 7595 tt; 2. Soviet Union - 1321 tt; 3. United Kingdom - 1181 tt; 4. France - 355 tt; 5. Argentina - 185 tt; 6. Taiwan - 145 tt; 7. Italy - 143 tt; 8. Spain - 141 tt; 9. Netherlands - 132 tt; 10. China - 129 tt; 11. Canada - 129 tt; 12. Greece - 114 tt; 13. Australia - 112 tt; 14. Japan - 105 tt



[ALBANIA](#)

[ARGENTINA](#)

[AUSTRALIA](#)

[AUSTRIA](#)

[BELGIUM](#)

[BRAZIL](#)

[BULGARIA](#)

[BURMA](#)

[CAMBODIA](#)

[CANADA](#)

[CEYLON](#)

[CHILE](#)

[CHINA](#)

[COLOMBIA](#)

[COSTA RICA](#)

[CUBA](#)

[DENMARK](#)

[DOMINICAN REPUBLIC](#)

[ECUADOR](#)

[EGYPT](#)

[EL SALVADOR](#)

[ETHIOPIA](#)

[FINLAND](#)

[FRANCE](#)

[GERMANY, EAST](#)

[GERMANY, WEST](#)

[GHANA](#)

[GREECE](#)

[GUATEMALA](#)

[HAITI](#)

[HONG KONG](#)

[HUNGARY](#)

[ICELAND](#)

[INDIA](#)

[INDONESIA](#)

[IRAN](#)

[IRAQ](#)

[IRELAND](#)

[ISRAEL](#)

[ITALY](#)

[JAPAN](#)

[KOREA, NORTH](#)

[KOREA, SOUTH](#)

[LAOS](#)

[LEBANON](#)

[LIBERIA](#)

[MALAYSIA](#)

[MEXICO](#)

[NETHERLANDS](#)

[NEW ZEALAND](#)

[NICARAGUA](#)

[NIGERIA](#)

[NORWAY](#)

[PAKISTAN](#)

[PARAGUAY](#)

[PERU](#)

[PHILIPPINES](#)

[POLAND](#)

[PORTUGAL](#)

[ROMANIA](#)

[SINGAPORE](#)

[SOUTH AFRICA](#)

[SOVIET UNION](#)

[SPAIN](#)

[SWEDEN](#)

[SYRIA](#)

[TAIWAN](#)

[THAILAND](#)

[TUNISIA](#)

[TURKEY](#)

[UNITED KINGDOM](#)

[UNITED STATES OF AMERICA](#)

[URUGUAY](#)

[VENEZUELA](#)

[VIETNAM, NORTH](#)

[VIETNAM, SOUTH](#)

[YUGOSLAVIA](#)



1576543

[Website Hit Counter](#)

[home](#)[World navies yesterday](#)[1960](#)

Albania 01 January 1960



PATROL AND COASTAL COMBATANTS

PC	pr. 122bis	4	191	1952		325t, 51.7x6.6x2.2m, 3d, 3600hp, 20kts, 54p; 1x1-85/52, 2x1-37/73, 2x2-12.7, 2dct, 2dcr, 18mines; Giuys radar, Tamir-9 sonar
			192	1952		
			501	1951		
			503	1951		
PT	Vosper	7	1-7	1943-44		45t, 22.1x5.9x1.7m, 3pe, 3375hp, 39kts, 11p; 1x1-20/70, 2x2-12.7, 2-533TT, 2dc; SO radar
	pr. 123bis	6	31-36	1944-48		21t, 18.7x3.4x1.2m, 2pe, 2400hp, 48kts, 7p; 2x2-12.7, 2-450TT
PB	Tirana	2	1, 2	1926	No picture	46t, 24.4xxm, 2d, 450hp, 17kts; 1x1-76/40

AMPHIBIOUS

LSS	MFP	2	1	1943		239t, 49.8x6.6x1.4m, 3d, 375hp, 10.5kts, 21p; 1x1-75/35, 4x1-20/65; 3tanks
			2	1943		

MINE WARFARE

MSI	pr. 255K	4	153	1951		161t, 38.0x5.7x1.6m, 3d, 690hp, 12kts, 37p; 2x1-45/68, 2x1-12.7, 2dcr, mechanical, acoustic, magnetic minesweeping gear; Tamir-10 sonar
			154	1951		
			155	1951		
			156	1951		
MSB	KM4	2	1, 2	1943-45		12t, 19.3x3.4x0.8m, 2pe, 126hp, 10kts, 10p; mechanical minesweeping gear
	pr. T361	9	1-9	1951-60		20t, 15.8x3.4x0.9m, 2d, 300hp, 11.6kts, 9p; 1x2-14.5, mechanical or magnetic or acoustic minesweeping gear

© Ivan Gogin, 2016

[home](#)[World navies yesterday](#)[1960](#)

Argentina 01 January 1960

SUBMARINES

SS	Santa Fe	1	S3	Salta	1933		935/1155t, 69.2x6.7x5.1m, 2d/em, 3000/1400hp, 17.5/9kts, 40p, 80m; 1x1-102/40, 1x1-40/60, 8-533TT
----	----------	---	----	-------	------	--	---

AIRCRAFT CARRYING SHIPS

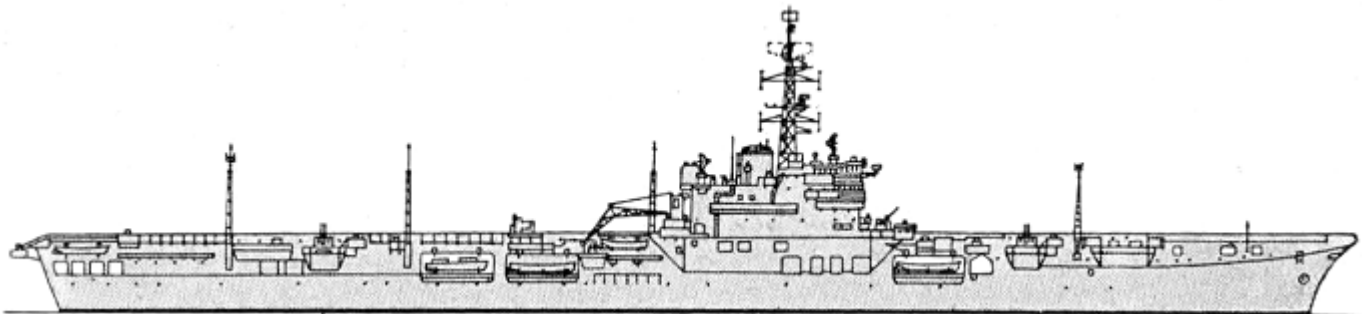
CVL	Colossus	1	V1	Independencia	1946		18300t, 211.2x24.4x7.1m, 4b,2gst, 40000hp, 25kts, 1300p; (1x4+9x2)-40/60, 22aircraft (F4U fighters); type 277, 279, SPS-6C radars
-----	----------	---	----	---------------	------	---	---

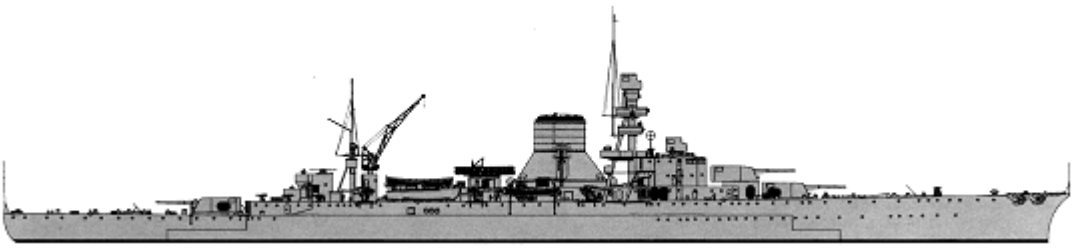
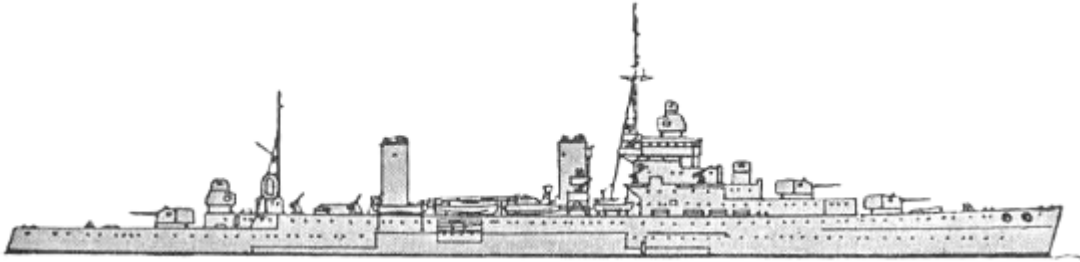

PRINCIPAL SURFACE COMBATANTS

CA	Almirante Brown	2	C1	Almirante Brown	1931		9000t, 170.8x17.8x4.7m, 6b,2gst, 85000hp, 32kts, 780p; 70belt, 25deck, 50turrets, 65CT; 3x2-190/52, 10x2-40/60, 6-533TT; type 268 radar
			C2	25 de Mayo	1931		
CL	La Argentina	1	C3	La Argentina	1939		8500t, 164.9x17.2x5.0m, 4b,4gst, 54000hp, 30kts, 800p; 76belt, 51deck, 51turrets, 76CT; 3x3-152/50, (4x2+6x1)-40/60, 2x3-533TT; type 268, Mk8, SA-3 radars
				General			

	Brooklyn	2	C4	Belgrano	1939		13645t, 185.4x21.0x7.3m, 8b,4gst, 100000hp, 30kts, 868p; 127belt, 51deck, 165turrets, 127CT; 5x3-152/47, 8x1-127/25, (4x4+6x2)-40/60, 19x1-20/70(4), 2helicopters; SK, SG, Mk3(4), Mk13(5), 2x Mk4(4), 2x Mk28(5) radars
			C5	9 de Julio	1939		
DD	Cervantes	2	D1	Cervantes	1927		2087t, 101.5x9.7x3.7m, 4b,2gst, 42000hp, 36kts, 175p; 4x1-120/45, 3x2-40/60, 2x3-533TT, 2dcr
			D2	Juan de Garay	1927		
	Mendoza	3	D3	Mendoza	1929		2120t, 102.1x9.7x3.8m, 4b,2gst, 42000hp, 36kts, 160p; 4x1-120/45, 3x2-40/60, 2x1-40/39, 2x3-533TT
			D4	La Rioja	1929		
			D5	Tucumán	1929		
	Buenos Aires	6	D6	Buenos Aires	1938		2010t, 98.5x10.6x3.2m, 3b,2gst, 34000hp, 35.5kts, 130p; 3x1-120/45, 4x1-40/60, 2-324TC, 2x24-178 Hedgehog ASWRL, 4dct, 1dcr
			D7	Entre Ríos	1938		
			D9	San Juan	1938		
			D10	San Luis	1938		
			D11	Misiones	1938		
			D12	Santa Cruz	1938		
	FF	Ashville	1	P31	Hércules	1942	
Tacoma		3	P32	Heroína	1944		2238t, 92.6x11.4x3.9m, 3b,2vte, 5500hp, 20kts, 190p; 3x1-105/45(32,34), 2x1-105/45(33), (2x2+4x1)-40/60, 1x24-178 Hedgehog ASWRL, 8dct, 2dcr; SA, SU, Mk26 radars, sonar
			P33	Sarandí	1944		
			P34	Santísima Trinidad	1943		
	Murature	2	P20	Murature	1945		1032t, 76.8x8.8x2.3m, 2d, 2500hp, 18kts, 130p; 3x1-105/45, (1x2+2x1)-40/60, 2x1-12.7, 4dct
			P21	King	1946		
FS	Flower	1	P10	República	1943		1370t, 63.5x10.1x4.4m, 2b,1vte, 2750hp, 16.5kts, 109p; 1x1-105/45, 2x1-40/60, 2x1-20/70, 4dct, 2dcr; type 268, 276 radars,



						sonar
Azopardo	2	P35	Azopardo	1957		1400t, 92.7x9.6x4.0m, 2b,2gst, 5000hp, 20kts, 170p; 1x1-105/45, 2x2-40/60, 1x24-178 Hedgehog ASWRL, 4dct, 2dcr; Decca radar, sonar
		P36	Piedra Buena	1958		

PATROL AND COASTAL COMBATANTS

PC	Sotoyomo	2	1	Yamana	1943		835t, 43.6x10.3x4.0m, 2dg, 2em, 1500hp, 13kts, 49p; 1x1-40/60, 2x1-20/70; Decca 1226 radar
			2	Sanaviron	1947		
PT	LT1	8	P80 - 84, 86 - 88	LT1 - 5, 7 - 9	1948		50t, 23.8x6.4x1.5m, 3pe, 4500hp, 42kts, 10p; 2x1-40/60, 4-533TC; SO radar
PB	Dorado	1	GC101	Dorado	1939	No picture	43t, 21.2x4.3x1.5m, 2d, 360hp, 12kts, 7p

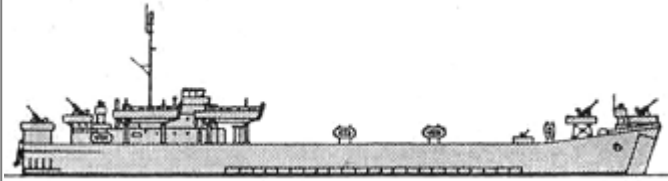
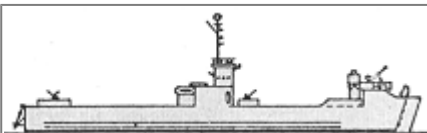
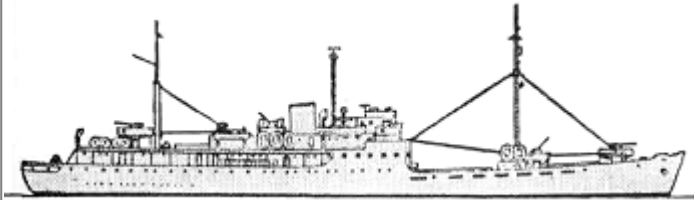
AMPHIBIOUS

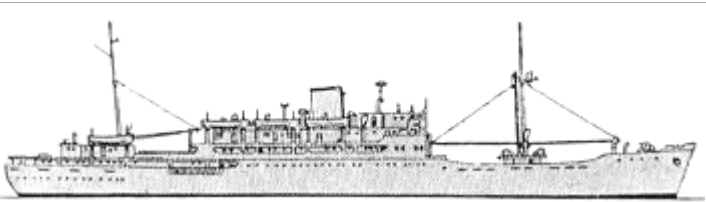
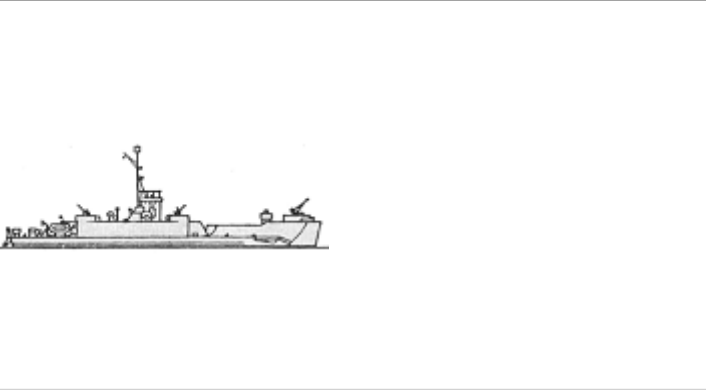
LST	LST(2)	10	Q41	Cabo San Bartolomé	1945		4080t, 100.0x15.2x4.3m, 2d, 1800hp, 12.1kts, 125p; 20tanks, 163troops; radar
			Q42	Cabo San Diego	1944		
			Q43	Cabo San Francisco de Paula	1944		
			Q44	Cabo San Gonzalo	1945		
			Q46	Cabo San Isidro	1944		
			Q47	Cabo San Pablo	1944		
			Q50	Cabo San Pio	1945		
			Q51	Cabo San Sebastián	1945		
			Q53	Cabo Buen Tiempo	1945		
			Q54	Cabo San Vicente	1944		
LSM	LSM1	2	Q69	BDM1	1944		1095t, 62.0x10.5x2.1m, 2d, 2800hp, 12.5kts, 60p; 1x2-40/60, 4x1-20/70; 5tanks, 54troops
			Q70	BDM2	1944		
LPA	Bahía Aguirre	3	B2	Bahía Aguirre	1950		5000t, 102.5x14.4x7.9m, 2d, 3750hp, 16kts, 71p; troops; radar
			B6	Bahía Buen Suceso	1950		
			B8	Bahía Thetis	1950		
			B10	Lapataia	1951		

	Lapataia	3	B11	Le Maire	1951		3825t, 103.9x15.4x9.4m, 2d, 3400hp, 15kts, 71p; troops; radar
			B12	Les Eclaireurs	1951		
LCU	LCI(L)	9	Q54	BDI1	1944		385t, 48.9x7.2x1.6m, 8d(2), 2320hp, 15.5kts, 29p; 5x1-20/70; 209troops; SCR-517A radar
			Q55	BDI2	1944		
			Q57	BDI4	1944		
			Q58	BDI5	1944		
			Q59	BDI6	1944		
			Q60	BDI7	1944		
			Q65	BDI12	1944		
			Q67	BDI14	1944		
			Q68	BDI15	1944		
LC	LCVP	29	1 - 29	EDVP1 - 29	1943 - 1945		13t, 11.2x3.2x0.9m, 2d, 220-450hp, 8kts, 3p; 2x1-12.7; 36troops

MINE WARFARE SHIPS

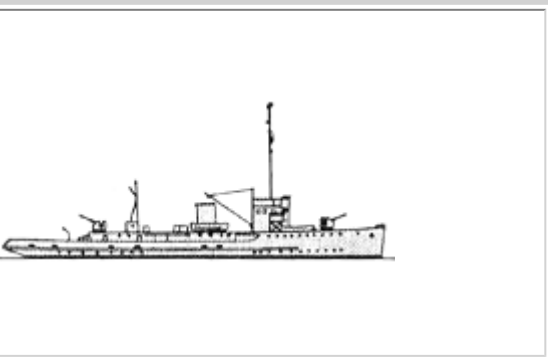
MSO	Bouchard	8	M2	Drummond	1937		520t, 59.0x7.3x2.3m, 2d, 2000hp, 15kts, 62p; 2x1-102/50, 2x1-40/39, sweeps
			M3	Robinson	1939		
			M4	Granville	1937		
			M7	Bouchard	1937		
			M10	Py	1939		
			M11	Parker	1938		
			M12	Seaver	1939		
			M13	Spiro	1938		

[home](#)

[World navies yesterday](#)



[1960](#)

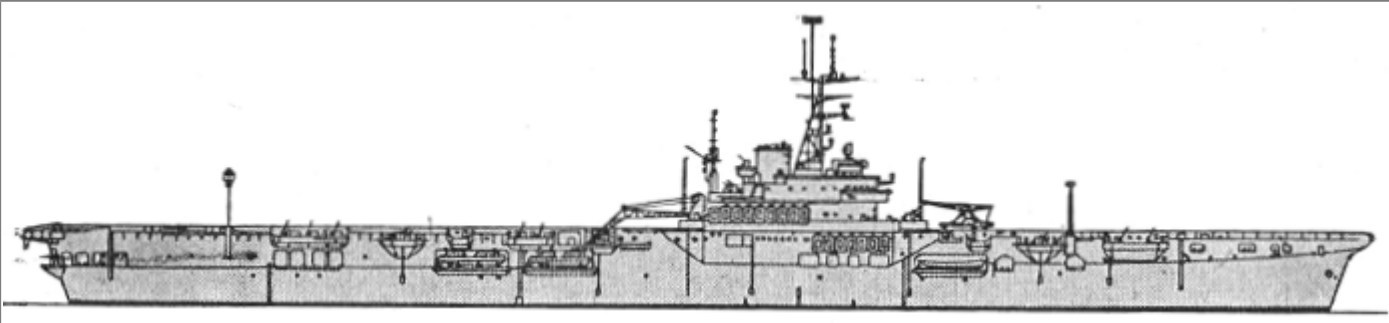
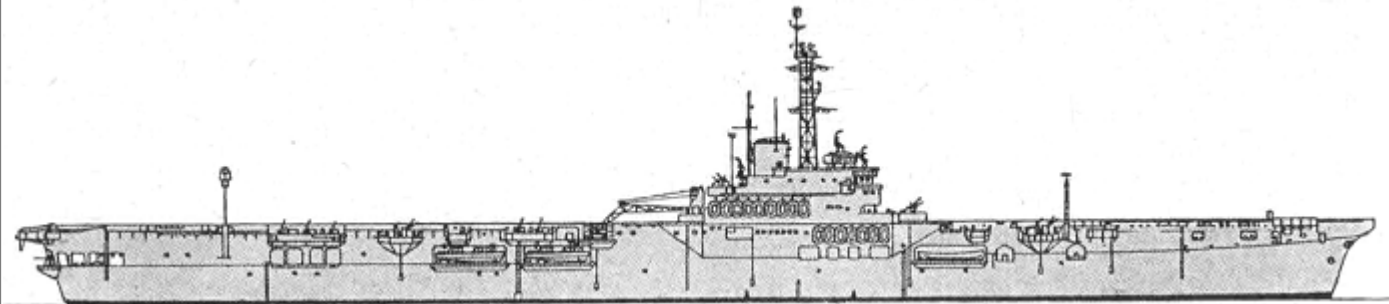

Australia 01 January 1960

AIRCRAFT CARRIERS

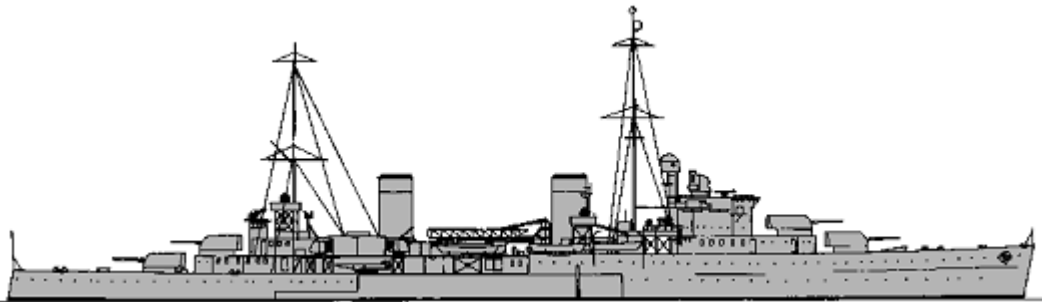
CVL	Magnificent	1	R17	Sydney	1949		17780t, 211.8x24.4x7.0m, 4b,2gst, 40000hp, 25kts, 1300p; (6x2+18x1)-40/60, 26aircraft (Sea Venom fighters, Gannet ASW planes, Wessex helicopters); 2x type 277Q, 293M, 960/281BQ, 961 radars
	Magnificent mod.	1	R21	Melbourne	1955		19966t, 213.8x38.4x7.8m, 4b,2gst, 42000hp, 24kts, 1417p; (7x2+11x1)-40/60, 24aircraft(Sea Venom fighters, Gannet ASW planes, Wessex helicopters); type 3x 277Q, 293Q, 978 radars

PRINCIPAL SURFACE COMBATANTS

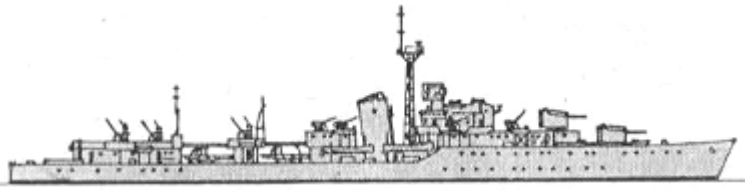
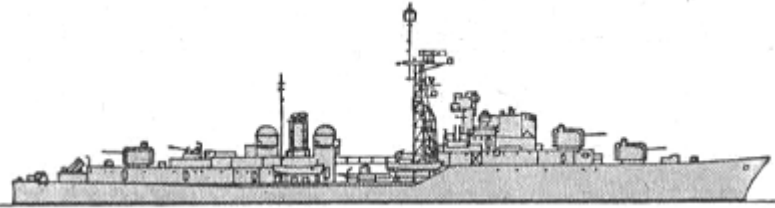
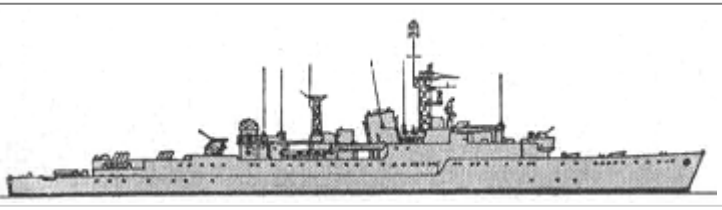
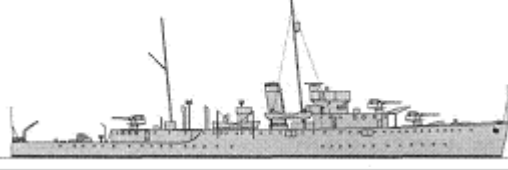
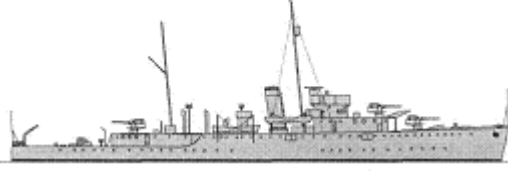
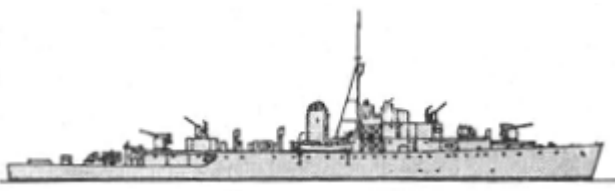
CL	Amphion	1	C02	Hobart	1936		9420t, 171.4x17.3x6.0m, 4b,4gst, 72000hp, 32.5kts, 570p; 76belt, 51deck, 25turrets; 3x2-152/50, 4x2-102/45, (2x4+3x2+5x1)-40/60, 2x4-40/39, (1x2+2x1)-20/70, 2x4-533TT; type 276, 277, 281B, 282, 283, 285, SG-1, Mk3 radars
	Tribal	2	D123	Warramunga	1942		2710t, 114.9x11.1x4.2m, 3b,2gst, 44000hp, 36.2kts, 250p; 2x2-120/45, 1x2-102/45, 1x2-40/60, 1x4-533TT, 1x3-305 Squid ASWRL, 2dct, 2dcr; type 272, 275, 291 radars, type 127 sonar
			D130	Arunta	1942		

DD	Battle batch 3	2	D37	Tobruk	1950		3450t, 115.5x12.5x4.7m, 2b,2gst, 50000hp, 35.7kts, 332p; 2x2-120/45, (3x2+6x1)-40/60, 2x5-533TT, 1x3-305 Squid ASWRL; type 262, 275, 277, 291, 293 radars, type 170, 174 sonars
			D59	Anzac	1951		
Daring	3	D04	Voyager	1957		3600t, 118.9x13.1x4.1m, 2b,2gst, 54000hp, 34.7kts, 320p; 3x2-120/45, 3x2-40/60(04), (2x2+2x1)-40/60(08,11), 1x5-533TT(04,08), 1x3-305 Squid ASWRL; type 275, 262, 293 radars, type 170, 174/177 sonars	
		D08	Vendetta	1958			
		D11	Vampire	1959			
Q	4	F01	Quadrant	1942		2850t, 109.2x10.9x4.3m, 2b,2gst, 40000hp, 36.7kts, 195p; 1x2-102/45, (1x2+3x1)-40/60, 2x3-305 Squid ASWRL(01), 2x3-305 Limbo ASWRL(02-04); type 262, 278, 293 radars, type 170, 174 sonars	
		F02	Queenborough	1942			
		F03	Quiberon	1942			
		F04	Quickmatch	1942			
FF	Swan	1	F74	Swan	1937		1510t, 81.2x11.0x3.1m, 2b,2gst, 2000hp, 16.5kts, 100p; 1x2-102/45, 1x1-40/60; sonar
	Parramatta	1	F312	Warrego	1940		1510t, 81.2x11.0x3.1m, 2b,2gst, 2200hp, 16.8kts, 100p; 1x2-102/45, 1x1-40/60; sonar
	River	5	F174	Barcoo	1944		2180t, 91.8x11.2x3.9m, 2b,2vte, 5500hp, 20kts, 140p; 2x1-102/45(402,403), 1x2-102/45(174,363,532), 3x1-40/60(402), 1x1-40/60(174,363), (2x2+4x1)-20/70(403), 1x24-178 Hedgehog ASWRL(402,403), 2x3-305 Squid ASWRL(174,363,532), 8dct, 2dcr; type 272, 275(174,363), 291 radars, sonars
			F363	Hawkesbury	1944		
			F402	Barwon	1946		
			F403	Burdekin	1944		
River modified	4	F532	Macquarie	1945		2187t, 91.7x11.1x3.9m, 2b,2vte, 5500hp, 19kts, 177p; 2x2-102/45, 3x1-40/60, 2x2-20/70, 1x24-178 Hedgehog ASWRL, 4dct, 2dcr; type 275, 277, 291 radars, sonars	
		F408	Culgoa	1947			
		F442	Murchison	1945			
			F535	Shoalhaven	1946		
			F698	Condamine	1946		

PATROL AND COASTAL COMBATANTS

PB	HDML	3	1-3	ML1321,1324,1325	1943 - 1944		54t, 22.0x4.8x1.4m, 2d, 300hp, 11.5kts, 10p; 2x1-20/70, 8dcr; type 291 radar
----	------	---	-----	------------------	-------------	--	--

MINE WARFARE SHIPS

MSO	Bathurst	13	M05	Colac	1942
			M34	Ararat	1943
			M183	Wagga	1942
			M186	Cootamundra	1943
			M203	Rockhampton	1942
			M207	Mildura	1941
			M218	Kapunda	1942
			M231	Bundaberg	1942
			M238	Gympie	1942
			M241	Bunbury	1943
			M246	Fremantle	1943
			M351	Cowra	1943
			M363	Strahan	1944

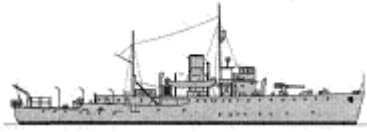

790t, 56.7x9.5x3.0m, 2b,2vte, 1550-2000hp, 15-16kts, 90p; 1x1-102/45, 1x1-40/60, 2x1-20/70, 4dct, 2dcr, sweeps; radar, sonar

[home](#)

[World navies yesterday](#)

[1960](#)

Austria 01 January 1960

PATROL AND COASTAL COMBATANTS

PR	Oberst Brecht	1	A601	Oberst Brecht	1958	No picture	10t, 12.3x2.5x0.8m, 2d, 290hp, 14kts, 5p; 1x1-12.7, 1x1-84 ATR
----	---------------	---	------	---------------	------	------------	--

© Ivan Gogin, 2016

[home](#)[World navies yesterday](#)[1960](#)

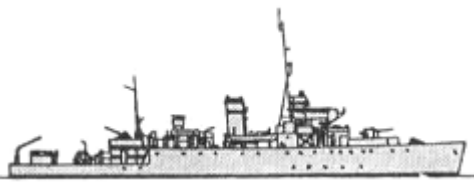
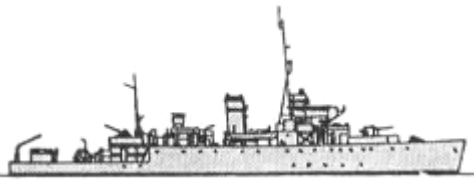

Belgium 01 January 1960

PATROL AND COASTAL COMBATANTS

PS	Canadian Algerine	2	F901	Georges Lecointe	1943		1325t, 68.6x10.8x3.3m, 2b,2vte, 2400hp, 16.5kts, 138p; 1x1-102/45, 4x2-20/70, 4dct, 2dcr; radar, sonar
			F903	A. F. Dufour	1943		
	Algerine	2	F904	De Brouwer	1943		1335t, 68.6x10.8x3.2m, 2b,2gst, 2000hp, 16kts, 101p; 1x1-102/45, 4x1-40/60, 4dct, 2dcr; radar, sonar
			F905	De Moor	1943		

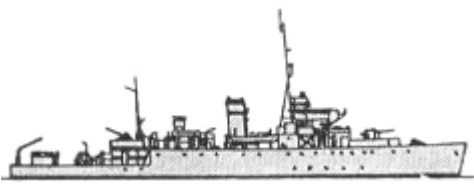
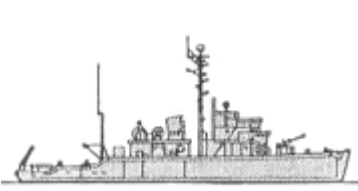
MINE WARFARE

MSO	Algerine	1	M902	Jan Van Haverbeke	1943		1335t, 68.6x10.8x3.2m, 2b,2gst, 2000hp, 16kts, 101p; 1x1-102/45, 4x1-40/60, 4dct, 2dcr; minesweeping gear; radar, sonar
	Aggressive	4	M906	Breydel	1956		780t, 52.4x11.0x4.2m, 2d, 1520hp, 14kts, 72p; 1x1-40/60, 2x1-12.7, mechanical, magnetic, acoustic minesweeping gear; SPS-53 radar, UQS-1 sonar
M907			Artevelde	1955			
M908			Georges Truffault	1956			
M909			François Bovesse	1957			
			M910	Diest	1953		
			M911	Eeklo	1953		
			M912	Lier	1953		
			M913	Maaseik	1953		
			M914	Roeselare	1953		
			M915	Arlon	1953		
			M916	Bastogne	1953		

MSC	Adjutant	26	M917	Charleroi	1954		390t, 44.3x8.1x2.1m, 2d, 880hp, 13.5kts, 36p; 1x2-20/70, mechanical, acoustic, magnetic minesweeping gear; Decca 1229 radar, UQS-1 sonar
			M918	Saint-Niklaas	1954		
			M919	Saint-Truiden	1954		
			M920	Diksmuide	1954		
			M921	Herve	1954		
			M922	Malmédy	1953		
			M923	Blankenberge	1954		
			M924	La Roche	1954		
			M925	De Panne	1954		
			M926	Mechelen	1954		
			M927	Spa	1955		
			M928	Stavelot	1956		
			M929	Heist	1956		
			M930	Rochefort	1955		
			M931	Knokke	1955		
			M932	Nieuwpoort	1955		
			M933	Koksijde	1955		
M934	Verviers	1956					
M935	Veurne	1956					
MSI	Ham	16	M470	Temse	1958		190t, 34.5x6.7x2.1m, 2d, 1260hp, 15kts, 17p; 1x2-20/70, minesweeping gear; Decca 1229 radar
			M471	Hasselt	1958		
			M472	Kortijk	1958		
			M473	Lokeren	1958		
			M474	Turnhout	1958		
			M475	Tongeren	1958		
			M476	Merksem	1959		
			M477	Oudenaarde	1959		
			M478	Herstal	1957		
			M479	Huy	1958		
			M480	Seraing	1958		
M481	Tournai	1958					
M482	Visé	1958					
M483	Ougrée	1958					
M484	Dinant	1959					
M485	Andenne	1959					

[home](#)[World navies yesterday](#)[1960](#)

Brazil 01 January 1960

SUBMARINES

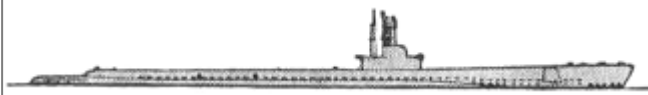

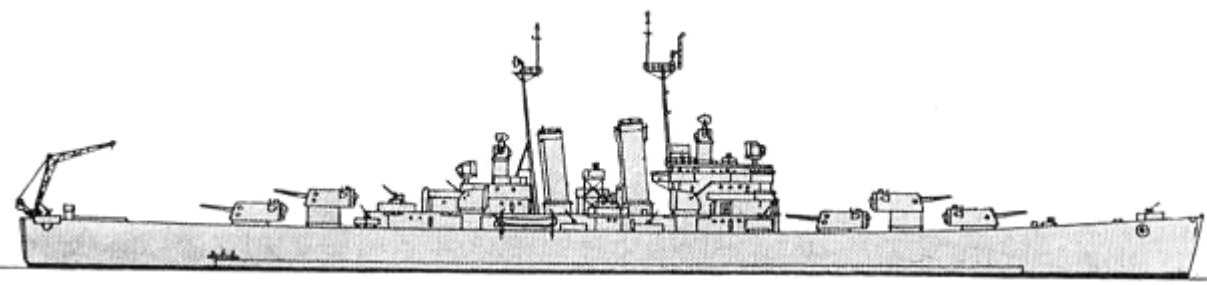
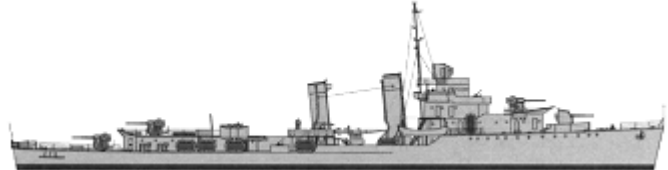
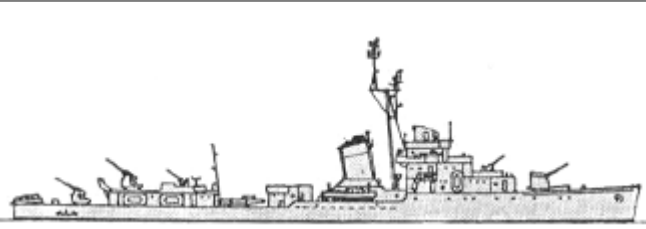
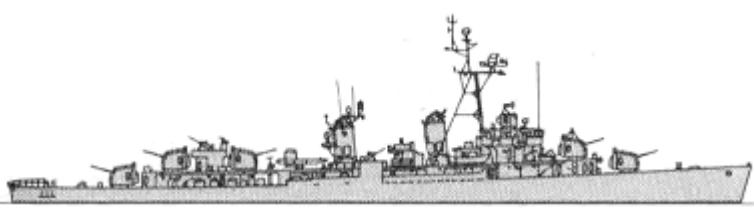

SS	Gato	2	S14	Humaitá	1943		1810/2410t, 95.0x8.3x4.7m, 4dg/4em(2), 5400/2740hp, 20.2/8.7kts, 60p, 90m; 10-533TT; SS, ST, SV radars, sonars
			S15	Riachuelo	1943		

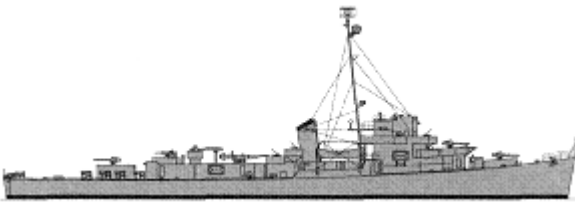
PRINCIPAL SURFACE COMBATANTS

CL	Brooklyn	2	C11	Barroso	1938		12700(11)-13500(12)t, 185.4x21.2(11)-21.0(12)x6.9(11)-7.4(12)m, 8b,4gst, 100000hp, 32.5kts, 868p; 127belt, 51deck, 165turrets; 5x3-152/47, 5x2-127/38(12), 8x1-127/25(11), (4x4+6x2)-40/60, 10x2-20/70(11), 8x1-20/70(12), 1helicopter; SK(11), SK-2(12), SG, Mk13(11), Mk8(12), 2x Mk4(11), 2x Mk28(12) radars
			C12	Tamandaré	1939		
Mariz e Barros		3	D24	Greenhalgh	1943		2200t, 108.8x10.6x3.0m, 4b,2gst, 42800hp, 36.5kts, 190p; 4x1-127/38, 2x2-40/60, 4x1-20/70, 1x4-533TT, 4dct, 2dcr; sonar
			D25	Marcílio Dias	1943		
			D26	Mariz e Barros	1943		
DD	Amazonas	6	D10	Acre	1951		1800t, 98.5x10.7x2.6m, 3b,2gst, 34600(10,11)-45000(12-15)hp, 33.5(10,11)-36(12-15)kts, 150p; 3x1-127/38, 2x2-40/60, 4x1-20/70, 2x3-533TT, 8dct, 2dcr; SPS-4, SPS-10 radars, sonar
			D11	Ajuricaba	1951		
			D12	Amazonas	1949		
			D13	Apa	1951		
			D14	Araguaya	1949		
Fletcher		2	D27	Pará	1942		3005t, 114.7x12.1x4.2m, 4b,2gst, 60000hp, 38kts, 273p; 5x1-127/38, 5x2-40/60(27), (2x4+3x2)-40/60(28), 7x1-20/70(27), (4x2+3x1)-20/70(28), 1x5-533TT, 2-324TC(27), 2x24-178 Hedgehog ASWRL, 1dcr; SPS-6, SPS-10, Mk12/22 radars, SQS-4/29 sonar
			D28	Paraíba	1943		
			D16	Bertioga	1943		
			D17	Beberibe	1943		

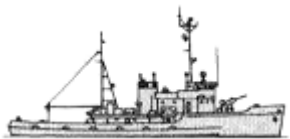
FF	Cannon	8	D18	Bracuí	1943		1602t, 93.3x11.2x3.2m, 4dg, 2em, 6000hp, 21kts, 186p; 3x1-76/50, 1x2-40/60, 8x1-20/70, 1x3-533TT, 1x24-178 Hedgehog ASWRL, 8dct, 2dcr; SA, SU radars, sonar
			D19	Bauru	1943		
			D20	Baependi	1943		
			D21	Benavente	1943		
			D22	Babitonga	1943		
			D23	Bocaina	1943		

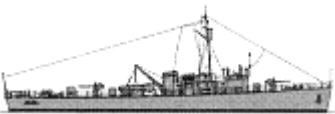
PATROL AND COASTAL COMBATANTS

PCO	Sotoyomo	3	R21	Tritão	1945		835t, 43.6x10.3x4.0m, 2dg,2em, 1500hp, 13kts, 49p; 1x1-76/50, 2x1-20/70; radar
			R22	Tridente	1945		
			R23	Triunfo	1945		
PCO	Imperial Marinheiro	10	V15	Imperial Marinheiro	1955		960t, 55.7x9.6x3.6m, 2d, 2160hp, 16kts, 70p; 1x1-76/50, 4x1-20/70; Decca radar
			V16	Iguatemi	1955		
			V17	Ipiranga	1955		
			V18	Forte de Coimbra	1955		
			V19	Caboclo	1955		
			V20	Angostura	1955		
			V21	Bahiana	1955		
			V22	Mearim	1955		
V23	Purus	1955					
V24	Solimões	1955					
PC	PC	4	G2	Gurupi	1942		330t, 52.9x7.1x2.4m, 2d, 2880hp, 21kts, 65p; 2x1-76/50(2), 1x1-76/50(5,7,8), 1x1-40/60(5,7,8), 3x1-20/70, 2x4-178 Mousetrap ASWRL(5,7,8), 2dct, 2dcr; SCR-517A radar, sonar
			G5	Guajará	1943		
			G7	Grajaú	1943		
			G8	Graúna	1942		
RMON	Parnaíba	1	U17	Parnaíba	1938		720t, 55.0x10.2x1.5m, 2b,2vte, 1300hp, 12kts, 90p; 76belt, 38deck; 1x1-152/50, 2x1-87/13, 2x1-47/40, 4x1-20/70
	Paraguassú	1	U16	Paraguassú	1940		600t, 44.7x10.6x1.5m, 2b,2vte, 1100hp, 13kts, 71p; 19belt, 13deck; 1x1-120/50, 2x1-87/13, 2x1-47/40, 4x1-20/70
PGR	-	1	U15	Oyapock	1908		295t

AMPHIBIOUS

LC	EDVP	10	EDVP501-510	1959		13t, 10.9x3.2x1.0m, 1d, 180hp, 9kts, 3p; 2x1-12.7; 36troops
----	------	----	-------------	------	--	---

MINE WARFARE

MSO	Carioca	5	CV32	Cabedelo	1940		780t, 57.5ppx7.6x2.4m, 2b,2vte, 2200hp, 15kts, 70p; 1x1-102/45(1-3,5), 2x1-76/40(4), 4x1-20/70, 50mines or sweeps
			CV33	Camocim	1940		
			CV34	Cananéia	1939		
			CV35	Caravelas	1940		
			CV36	Carioca	1939		

© Ivan Gogin, 2015



[home](#)[World navies yesterday](#)[1960](#)

Bulgaria 01 January 1960

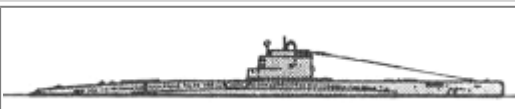
SUBMARINES

SS	pr.613	2	41	S-11 Slava	1956		1045/1342t, 76.0x6.3x4.6m, 2d/em, 4000/2700hp, 18.3/13.1kts, 55p, 170m; 6-533TT; Flag radar, Tamir-5L, Feniks sonars, Nakat ECM
			42	S-12 Pobeda	1956		

PRINCIPAL SURFACE COMBATANTS

DD	pr.30K	1	1	Georgi Dimitrov	1949		2860t, 117.0x11.0x4.7m, 4b,2gst, 54000hp, 36.5kts, 301p; 2x2-130/51, 1x2-85/52, 6x1-37/73, 2x3-533TT, 2dct, 2dcr, 60mines; Giuys-1B, Rif-1, Vympel-2, Rym-1 radars, Tamir-5N sonar
FF	pr.50	2	31	SKR-67	1956		1337t, 90.9x10.2x2.9m, 2b,2gst, 20000hp, 29kts, 168p; 3x1-100/56, 2x2-37/70, 1x2-533TT, 2x24 MBU-200 ASWRL, 4dct, 2dcr; Giuys-1M4, Lin', Don, Yakor' radars, Pegas-2M sonar, Bizan'-4 ECM
			32	SKR-53	1955		



PATROL AND COASTAL COMBATANTS

PC	pr.122bis	2	94		1955		325t, 51.7x6.6x2.2m, 3d, 3300hp, 20kts, 54p; 1x1-85/52, 2x1-37/73, 2x2-12.7, 2x5-250 RBU-1200 ASWRL, 1dcr, 18mines; Lin' radar, Tamir-10 sonar
			95		1955		
PT	TM52	2	4, 5		1940		38t, 21.4x6.1x1.1m, 3pe, 3300hp, 40kts, 14p; 2x1-20/80, 2-533TT, 2dcr
	TD-200bis	12	911-916, 921-926		1947-50		47t, 23.7x4.7x1.6m, 3d, 3000hp, 38kts, 11p; 2x2-12.7, 2-533TT, Zarnitsa radar
	pr.123K	12	301-312		1951-55		23t, 19.3x3.4x0.8m, 2d, 2000hp, 50kts, 7p; 1x2-14.5, 2-450TT, 2dcr; Zarnitsa radar
PB	pr.R376	18	301-306, 401-406, 451-456		1954-59		37t, 21.0x4.0x1.1m, 1d, 150hp, 10kts, 8p; 1x1-12.7; Donets-2 radar
PR	pr. 1124	2	BK-344, 346		1946		52t, 25.3x4.0x0.9m, 2pe, 1500hp, 18kts, 17p; 7belt, 4deck, 45turret, 8CT; 2x1-76/42, 1x1-37/73, 1x2-12.7

AMPHIBIOUS

LSS	mod. MFP	10	601	1950		240t, 47.0x8.0x1.3m, 3d, 450hp, 10.8kts, 27p; 2x1-37/73; 60mines or 3tanks (150t of cargo)
			602	1951		
			201	1951		
			202	1952		
			203	1952		
			204	1953		
			205	1953		
			206	1954		
			207	1954		
			208	1955		

MINE WARFARE

MSO	pr. 254	2	17	1950		569t, 58.0x8.5x2.3m, 2d, 2200hp, 14kts, 65p; 2x2-37/70, 4x2-12.7, 2dct, 2dcr; 16mines, mechanical, acoustic, magnetic minesweeping gear; Rif, Rym-K radars, Tamir-10 sonar
			18	1950		
MSI	pr. 255K	4	23	1950		161t, 38.0x5.7x1.6m, 3d, 690hp, 12kts, 37p; 2x1-45/69, 2x1-12.7, 2dcr, mechanical, acoustic, magnetic minesweeping gear; Tamir-10 sonar
			24	1950		
			25	1950		
			26	1950		
MSB	MChK	6	8-13	1941-45		25t, 17.3x3.0x1.0m, 1d, 100-120hp, 9-10kts, 8p; minesweeping gear

© Ivan Gogin, 2016





[home](#)[World navies yesterday](#)[1960](#)

Burma 01 January 1960

PRINCIPAL SURFACE COMBATANTS

FF	River	1	F266	Mayu	1943		2170t, 91.8x11.2x3.7m, 2b,2vte, 5500hp, 20kts, 140p; 1x1-102/40, 4x1-40/60; type 277, type 291 radars
----	-------	---	------	------	------	--	---

PATROL AND COASTAL COMBATANTS

PT	T201	5	T201-205		1956-1957		64t, 21.8x5.9x1.8m, 2d, 5000hp, 40kts, 15p; 1x1-40/60, (1x1-114/19 or 4-533TT or 6 mines); radar
PC	PGM401	4	PGM401		1959		141t, 30.8x6.5x2.3m, 8d(2), 2040hp, 17kts, 17p; 1x1-40/60, 2x2-20/70, 2x1-12.7; EDO320 radar
			PGM402		1959		
			PGM403		1959		
			PGM404		1959		
	Y301	10	Y301		1958		150t, 32.0x7.3x0.9m, 2d, 1100hp, 13kts, 29p; 2x1-40/60
			Y302		1958		
			Y303		1958		
			Y304		1958		
			Y305		1958		
			Y306		1958		
			Y307		1958		
			Y308		1958		
			Y309		1958		
			Y310		1958		
PG	LCG(M)	4	1	Indaw	1944		380t, 47.1x6.8x2.1m, 2d, 1000hp, 11.7kts, 39p; 25sides, 51deck, 25turrets, 25CT; 2x1-88/27, 2x1-40/39; type 974 radar
			2	Inlay	1944		
			3	Inma	1944		
			4	Inya	1944		

MINE WARFARE



MSO	Algerine	1	M380	Yan Myo Aung	1945		1335t, 71.6x10.8x3.5m, 2b,2vte, 2000hp, 16.5kts, 138p; 1x1-102/45, 4x1-40/60, 4dct, 2dcr, mechanical minesweeping gear, 16mines; Decca 202 radar, type 144 sonar
-----	----------	---	------	--------------	------	---	--

© Ivan Gogin, 2016

[home](#)[World navies yesterday](#)[1960](#)

Cambodia 01 January 1960

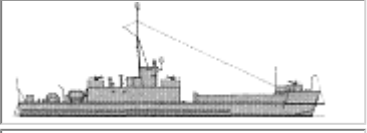
PATROL AND COASTAL COMBATANTS

PC	PC 173ft	2	E311	Cambodia	1944		430t, 52.9x7.1x2.4m, 2d, 2880hp, 20kts, 65p; 1x1-76/50, 1x1-40/60, 5x1-20/70, 2x4-178 Mousetrap ASWRL, 2dct, 2dcr; SO radar, sonar
			E312		1943		
PG	LCI(L)	2	P111		1944		387(111)-350(112)t, 48.9x7.2x1.7(111)-1.8(112)m, 8d(2), 2320hp, 15kts, 58(111)-40(112)p; 1x1-76/50, 1x1-40/60(111), 2x1-20/70(111), 5x1-20/70(112); SO radar
			P112		1943		
PB	HDML	3	VP748, 749, 762		1942- 1944		54t, 22.0x4.8x1.4m, 2d, 300hp, 10kts, 8p; 2x1-20/70

AMPHIBIOUS

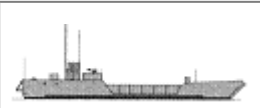
LSS	LCT(6)	3	T911		1944		309-320t, 36.3x10.0x1.2m, 3d, 675hp, 8kts, 13p; 2x1-20/70; 4tanks
			T912		1943		
			T913		1944		

© Ivan Gogin, 2016

[home](#)

[World navies yesterday](#)

[1960](#)



Canada 01 January 1960

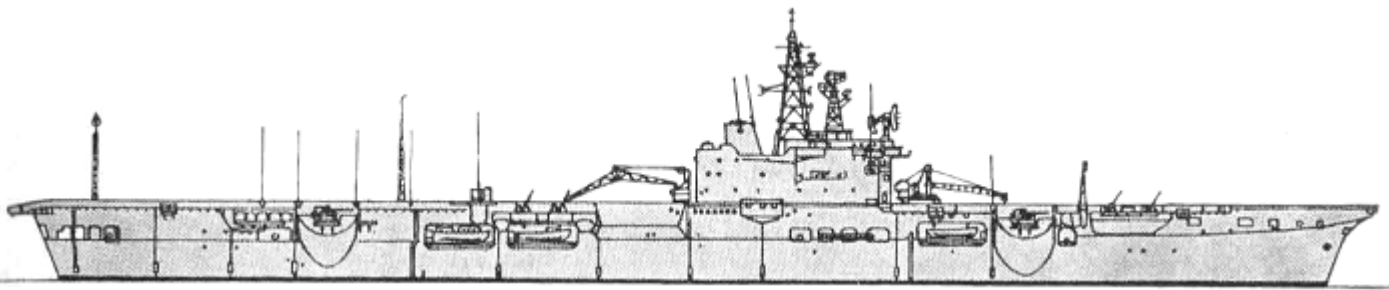

AIRCRAFT CARRIERS

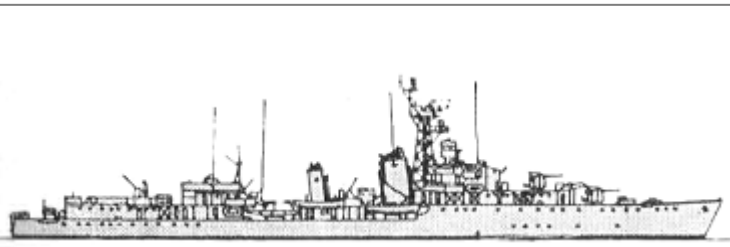
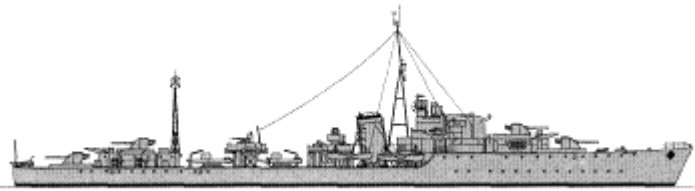
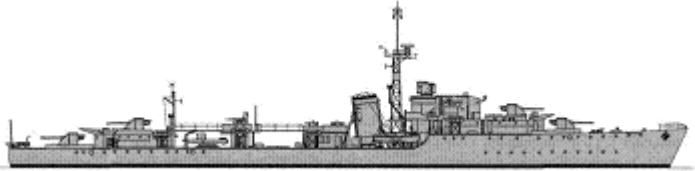
CVL	Majestic 1	RRSM22	Bonaventure	1957		<p>17780t, 211.8x24.4x7.0m, 4b,2gst, 40000hp, 25kts, 1370p; 4x2-76/50, 24aircraft(F2H-3 fighters, CS-2F ASW planes); SPS-10, SPS-12, SPS-8 radars</p>
-----	------------	--------	-------------	------	--	---

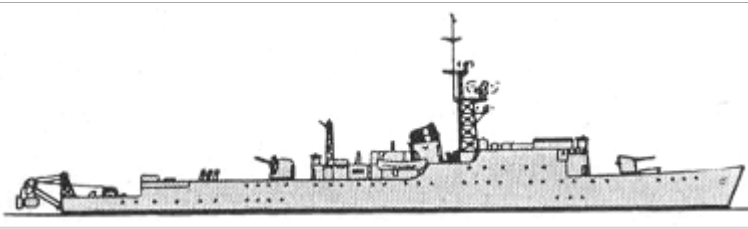
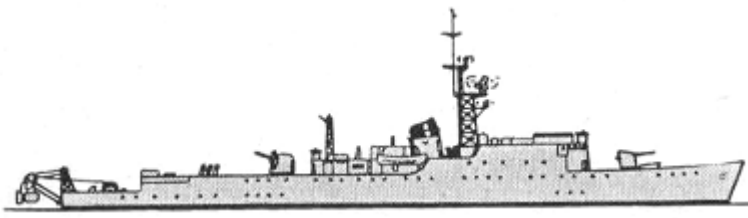
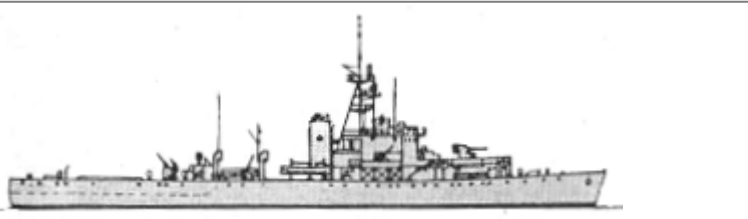
PRINCIPAL SURFACE COMBATANTS

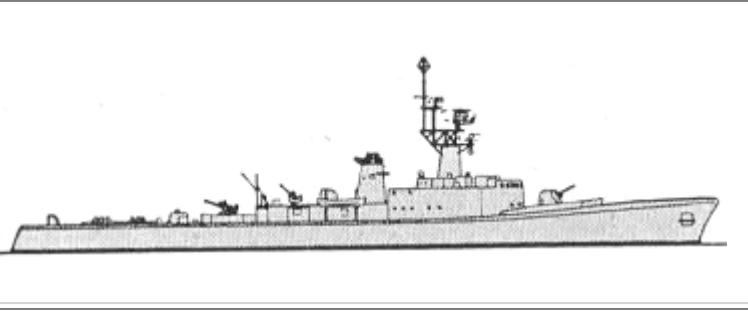
Tribal	7	DDE213	Nootka	1946		<p>2500t, 114.9x11.4x4.2m, 3b,2gst, 44000hp, 36.2kts, 250p; 2x2-102/45, 1x2-76/50, 4x1-40/60, 1x4-533TT, 2x3-305 Squid ASWRL; type 275(213-217), 293, 262, 268(213-217), 277(213-217), SPS-10(218,219), SPS-6(218,219), Mk28(218,219) radars, type 170, 174 sonars</p>	
		DDE214	Micmac	1945			
		DDE215	Haida	1943			
		DDE216	Huron	1943			
		DDE217	Iroquois	1942			
		DDE218	Cayuga	1947			
		DDE219	Athabaskan	1948			
DD	V	1	DDE225	Sioux	1944		<p>2545t, 110.6x10.9x4.4m, 2b,2gst, 40000hp, 36.7kts, 225p; 4x1-120/45, (1x2+2x1)-40/60, 2x2-20/70, 2x4-533TT, 4dct, 2dcr; type 275, 277, 282, 291 radars, type 123A, 127 sonars</p>
	Cr	1	DDE228	Crusader	1945		<p>2535t, 110.6x10.9x4.4m, 2b,2gst, 40000hp, 36.7kts, 222p; 4x1-114/45, (1x2+2x1)-40/60, 2x1-20/70, 1x4-533TT, 2dct, 2dcr; type 275, 277, 282, 291 radars, type 123A, 127 sonars</p>
	V pr. 16	1	DDE224	Algonquin	1944		<p>2850t, 109.2x10.9x4.3m, 2b,2gst, 40000hp, 36.7kts, 195p; 1x2-102/45, 1x2-76/50, 2x1-40/60, 2x3-305 Limbo ASWRL; type 278, 262, 293 radars, type 170, 174 sonars</p>

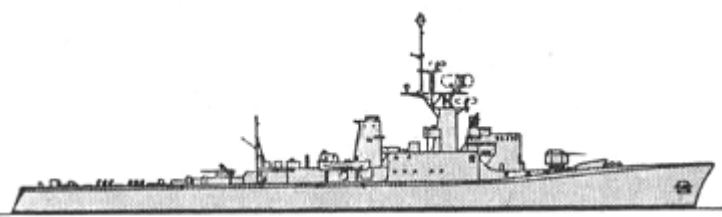

							
	Cr pr. 16	1	DDE226	Crescent	1945		2850t, 109.2x10.9x4.3m, 2b,2gst, 40000hp, 36.7kts, 195p; 1x2-102/45, 1x2-76/50, 2x1-40/60, 2x3-305 Limbo ASWRL; type 278, 262, 293 radars, type 170, 174 sonars
	early River	4	FFE304	New Waterford	1944		2180t, 91.8x11.2x3.9m, 2b,2vte, 5500hp, 20kts, 140p; 1x2-102/45, (1x2+4x1)-40/60, 2x3-305 Squid ASWRL; type 275, 262, SU, SPQ-2 radars, type 147, 162, 164B sonars, TDY-1 ECM
FFE306			Swansea	1943			
FFE310			Outremont	1943			
FFE315			New Glasgow	1943			
FF	later River	14	FFE301	Antigonish	1944		2360t, 91.8x11.2x3.9m, 2b,2vte, 5500hp, 20kts, 140p; 1x2-102/45, (1x2+4x1)-40/60, 2x3-305 Squid ASWRL, helodeck(314); type 275, SU, SPQ-2, type 262 radars, type 147, 162, 164B sonars, TDY-1 ECM
			FFE303	Beacon Hill	1944		
			FFE305	La Hullose	1944		
			FFE308	Inch Arran	1944		
			FFE309	Ste. Therese	1944		
			FFE311	Stetter	1944		
			FFE312	Fort Erie	1944		
			FFE313	Sussexvale	1944		
			FFE314	Buckingham	1944		
			FFE316	Prestonian	1944		
			FFE317	Cap de la Madeleine	1944		
			FFE318	Jonquiere	1944		
			FFE319	Toronto	1944		
			FFE320	Victoriaville	1944		
FFE321	Lanark	1944					
FFE322	Lauzon	1944					
	St. Laurent	7	DDE205	St. Laurent	1955		2600t, 113.1x12.8x4.2m, 2b,2gst, 30000hp, 28kts, 290p; 2x2-76/50, 2x1-40/60, 2x3-305 Limbo ASWRL; SPS-10, SPS-12, SPG-48 radars, SQS-501, SQS-502, SQS-503 sonars
DDE206			Saguenay	1956			
DDE207			Skeena	1957			
DDE229			Ottawa	1956			
DDE230			Margaree	1957			
DDE233			Fraser	1957			
DDE234			Assiniboine	1956			
			DDE257	Restigouche	1958		

	Restigouche	7	DDE235	Chaudiere	1959		2600t, 113.1x12.8x4.2m, 2b,2gst, 30000hp, 28kts, 290p; 1x2-76/70, 1x2-76/50, 2x1-40/60, 2x3-305 Limbo ASWRL, SPS-10, SPS-12, SPG-48, Sperry Mk II radars, SQS-501, SQS-502, SQS-503, SQS-10/11 sonars
			DDE236	Gatineau	1959		
			DDE256	St. Croix	1958		
			DDE258	Kootenay	1959		
			DDE259	Terra Nova	1959		
			DDE260	Columbia	1959		
			FS	Bangor diesel-engined	2		
FSE182	Granby	1942					
Bangor VTE-engined	1	FSE177		Drummondville	1941		875t, 54.9x8.7x3.1m, 2b,2vte, 2400hp, 16.5kts, 87p; 3x1-20/70, 1x24-178 Hedgehog ASWRL, 4dct, 2dcr, sweeps; radar, sonar
Bangor diesel-engined RCMP	4	J263		Cygnus (RCMP)	1941		690t, 49.4x8.5x2.8m, 2d, 2000hp, 16.5kts, 60p; 3x1-20/70, 1x24-178 Hedgehog ASWRL, 4dct, 2dcr; radar, sonar
		J265		Irvine (RCMP)	1942		
		J268		Herchmer (RCMP)	1942		
		J271		French (RCMP)	1942		

PATROL AND COASTAL COMBATANTS

PB	Bird	4	PCS780	Loon	1955		66t, 30.2x5.6x1.7m, 2d, 1200hp, 14kts, 21p; 1x1-20/70, 1x24-178 Hedgehog ASWRL, dcr; radar
			PCS781	Cormorant	1956		
			PCS782	Blue Heron (RCMP)	1956		
			PCS783	Mallard	1956		

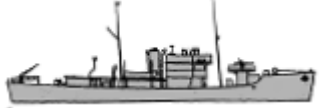
MINE WARFARE SHIPS

ML	Isles	2	1	Stonechat	1944		770t, 50.0x8.4x3.4m, 1b,1vte, 850hp, 12.2kts, 40p; 1x1-76/40, 3x1-20/70, mines
			2	Whitethroat	1944		
ML	Flower	1	AN113	Sackville	1941		1350t, 62.5x10.1x4.0m, 2b,1vte, 2750hp, 16.5kts, 38p; mines; radar
MSC	Cape	10	MCB149	Quinte	1954		412t, 46.3x8.5x2.6m, 2d, 2400hp, 15kts, 40p; 1x1-40/60, mechanical, acoustic, magnetic sweeps; radar
			MCB151	Fortune	1954		
			MCB152	James Bay	1954		
			MCB154	Resolute	1954		
			MCB159	Fundy	1956		

MCB160	Chignecto	1957
MCB161	Thunder	1957
MCB162	Cowichan	1957
MCB163	Miramichi	1957
MCB164	Chaleur	1957



© Ivan Gogin, 2015

[home](#)[World navies yesterday](#)[1960](#)

Ceylon 01 January 1960

PRINCIPAL SURFACE COMBATANTS

FF	River Canadian	2	F228	Gajabahu	1944	A side-view illustration of the River Canadian, a large river gunboat with a complex superstructure, including a mainmast and various deck-mounted equipment.	2180t, 91.8x11.2x3.9m, 2b,2vte, 5500hp, 20kts, 140p; 3x1-120/45, (4x2+2x1)-20/70, 6dct, 2dcr; type 268, type 272, type 275, type 291 radars, sonars
			F232	Mahasena	1944		

PATROL AND COASTAL COMBATANTS

PC	Ford	1	P3108	Kotiya	1954	A side-view illustration of the Ford, a smaller patrol and coastal combatant with a simpler superstructure and a single mainmast.	160t, 35.7x6.1x1.5m, 3d, 1200hp, 18kts, 19p; 1x1-40/60, 2dct, 2dcr; type 978 radar, type 144 sonar
----	------	---	-------	--------	------	---	--

MINE WARFARE



MSO	Algerine VTE	1	M370	Vijaya	1944	A side-view illustration of the Algerine VTE, a mine sweeper with a complex superstructure and a mainmast.	1325t, 68.6x10.8x3.3m, 2b,2vte, 2400hp, 16.5kts, 138p; 1x1-102/45, 4x1-40/60, 2dct, 2dcr, mechanical minesweeping gear; radar, sonar
	Algerine turbine	1	M293	Parakrama	1943	A side-view illustration of the Algerine turbine, a mine sweeper with a complex superstructure and a mainmast.	1265t, 68.6x10.8x3.2m, 2b,2gst, 2000hp, 16.5kts, 138p; 1x1-102/45, 4x1-40/60, 4dct, 2dcr, mechanical minesweeping gear; radar, sonar

© Ivan Gogin, 2016

[home](#)[World navies yesterday](#)[1960](#)

Chile 01 January 1960

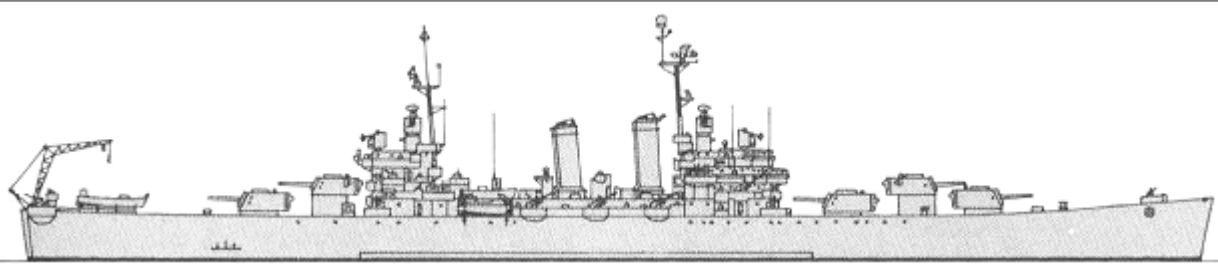
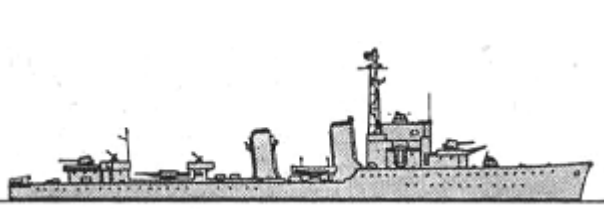

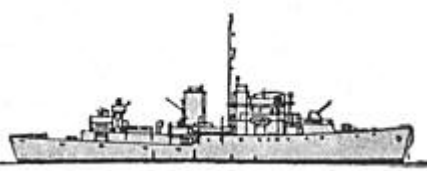
PRINCIPAL SURFACE COMBATANTS

CL	Brooklyn	1	O'Higgins	1938		13500t, 185.4x18.8x7.3m, 8b,4gst 100000hp, 32.5kts, 868p; 127belt, 51deck, 165turrets, 127CT; 5x3-152/47, 8x1-127/25, (6x4+2x2)-40/60, 6x2-20/70, 1helicopter(Jet Ranger); SPS-10, SPS-12, Mk13, 2x Mk28 radars
		2	Capitán Prat	1938		
DD	Serrano	H	Ingeniero Hyatt	1929		1430t, 91.4x8.8x3.9m, 3b,2gst, 28000hp, 35kts, 130p; 2x1-120/45, 3x1-20/70, 1x3-533TT, 1x24-178 Hedgehog ASWRL, 2dct; mines(S,O,H), sweeps(R)
		O	Capitán Orella	1928		
		R	Guardiamarina Riquelme	1929		
		S	Teniente Serrano	1928		
FF	River	B	Baquedano	1944		2180t, 91.8x11.2x3.9m, 2b,2vte, 5500hp, 20kts, 140p; 1x2-102/45, 1x1-76/40, (4x2+2x1)-20/70, 1x24-178 Hedgehog ASWRL, 8dct, 2dcr; type 268, 272, 275, 291 radars, sonars
		I	Iquique	1944		
		C	Covadonga	1944		
FS	Flower mod	C	Casma	1944		1370t, 63.5x10.1x4.4m, 2b,1vte, 2750hp, 16.5kts, 109p; 1x1-102/40, (2x2+2x1)-20/70, 1x24-178 Hedgehog ASWRL, 4dct, 2dcr; type 268, 276 radars, sonar
		C2	Chipana	1944		
		P	Papudo	1944		

PATROL AND COASTAL COMBATANTS

PS	Sotoyomo	1	Lautaro	1943		835t, 43.6x10.3x4.0m, 2dg,2em, 1500hp, 13kts, 49p; 1x1-40/60, 2x1-20/70; Decca 1226 radar
		2	Lientur	1944		
		3	Leucotón	1944		

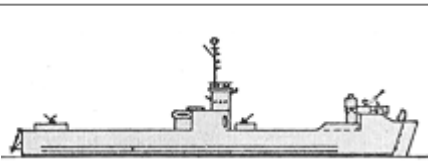
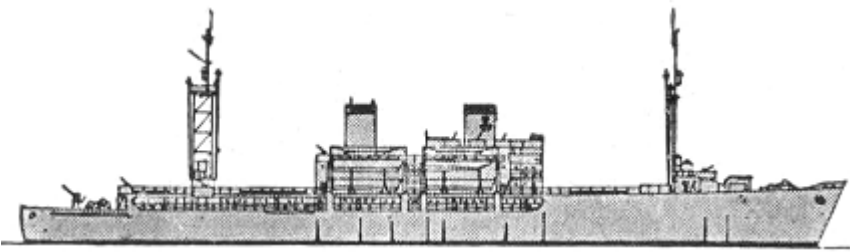
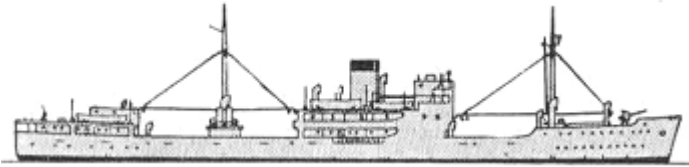
AMPHIBIOUS





LSM	LSM1	1	Aspirante Isaza	1944		1095t, 62.0x10.5x2.1m, 8d(2), 2800hp, 13.2kts, 60p; 1x2-40/60, 4x1-20/70; 5tanks, 54troops; radar
		2	Aspirante Goycolea	1945		
		3	Guardiamarina Contreras	1944		
LKA	Artemis	1	Presidente Errázuriz	1945		6740t, 129.9x17.7x4.7m, 2b,2tg,2em; 6000hp, 18kts, 303p; 1x1-127/38, 4x2-40/60, 10x1-20/70; 13 LCVP, 2 LCM(3), 1 LCPL, 2900t cargo, 252troops; radar
		2	Presidente Pinto	1945		
	Angamos	1	Angamos	1946		3800t, 104.0x11.9x4.6m, 2dg,2em, 2000hp, 14kts, 44p; 1x1-102/50, 2x1-20/70; cargo, troops
		1	Piloto Pardo	1959		
LCU	LCI(L)	1	Cabo Bustos	1944		385t, 48.9x7.2x1.6m, 8d(2)), 2320hp, 15.5kts, 29p; 5x1-20/70; 209troops; SCR-517A radar
		2	Eduardo Llanos	1944		

© Ivan Gogin, 2015

[home](#)[World navies yesterday](#)[1960](#)





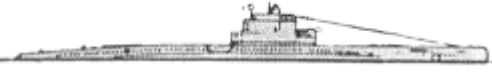

China 01 January 1960

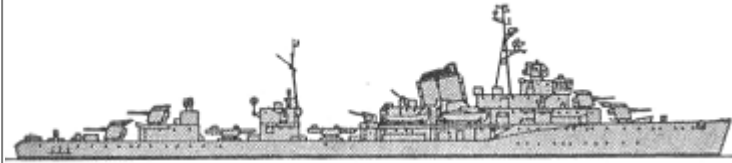
SUBMARINES

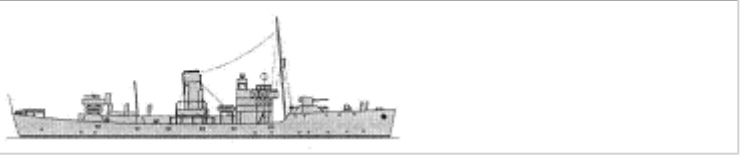

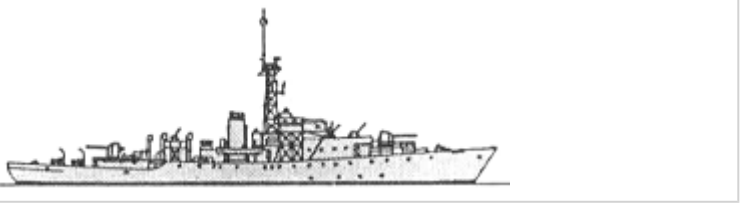
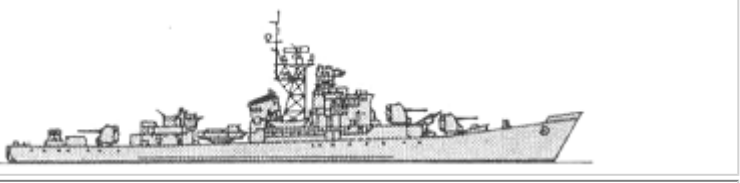

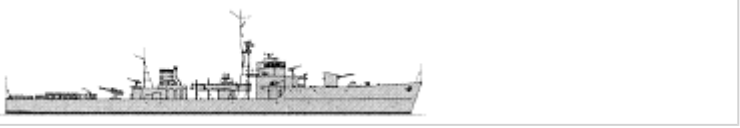
SS	ser. VI-bis	6	200		1935		161/202t, 37.8x3.1x2.6m, 1d/em, 685/240hp, 13.2/7.2kts, 17p, 50m; 1x1-45/46, 2-533TT
			201		1936		
			202		1936		
			203		1935		
			204		1936		
			205		1935		
	pr. 96	4	200	Changcheng 200	1950		280/351t, 49.5x4.4x2.8m, 2d/em, 1200/430hp, 15.5/7.9kts, 23p, 60m; 1x1-45/46, 4-533TT
			201	Changcheng 201	1951		
			202	Changcheng 202	1951		
			203	Changcheng 203	1951		
	ser. IX-bis	2	403	Changcheng 403 Xin Zhongguo	1943		856/1090t, 77.7x6.4x4.0m, 2d/em, 4000/1100hp, 18.9/8.6kts, 46p, 80m; 1x1-100/51, 1x1-12.7, 6-533TT; Tamir-5L sonar
			404	Changcheng 404 Fangyu	1943		
	ser. IX-bis-2	2	401	Changcheng 401	1947		844/1077t, 77.7x6.4x4.0m, 2d/em, 4000/1100hp, 19.4/9.5kts, 46p, 80m; 1x1-100/51, 1x1-12.7, 6-533TT; Tamir-5L sonar
			402	Changcheng 402	1948		
pr. 613	7	119	Changcheng 119	1957		1045/1342t, 76.0x6.3x4.6m, 2d/em, 4000/2700hp, 18.3/13.1kts, 55p, 170m; 1x2-25/112, 6-533TT; Flag radar, Tamir-5L, Feniks sonars, Nakat ECM	
		120	Changcheng 120	1958			
		122	Changcheng 122	1958			
		123	Changcheng 123	1958			
		127	Changcheng 127	1959			
		128	Changcheng 129	1959			
		129	Changcheng 131	1959			



PRINCIPAL SURFACE COMBATANTS

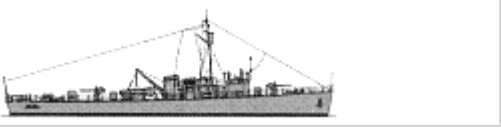

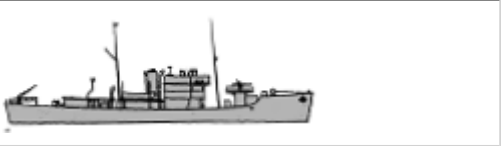

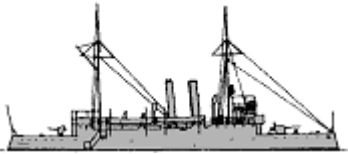
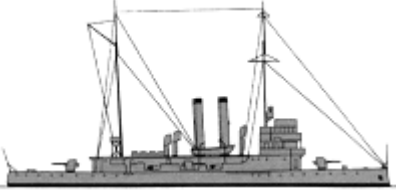
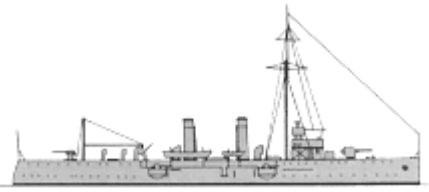
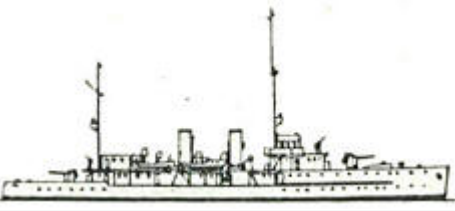
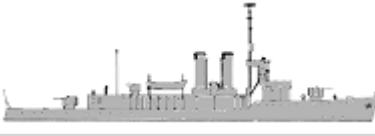
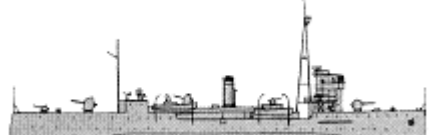

DD	pr. 7	4	101	Anshan	1941		2200t, 112.8x10.2x3.3m, 3b,2gst, 48000hp, 35kts, 246p; 4x1-130/51, 4x2-37/70, 2x3-533TT, 2dct, 2dcr, 60mines; Giuys-1, Rif-1, Vympel-2 radars, Tamir-5N sonar
			102	Fushun	1942		
			103	Changchun	1941		
			104	Taiyuan	1941		
			1	Kaifeng	1941		



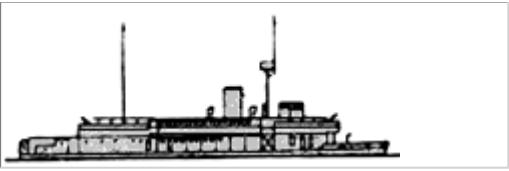

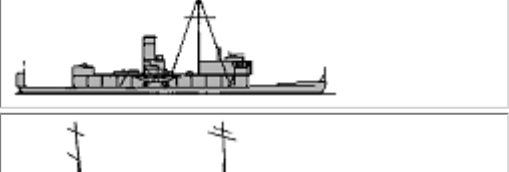
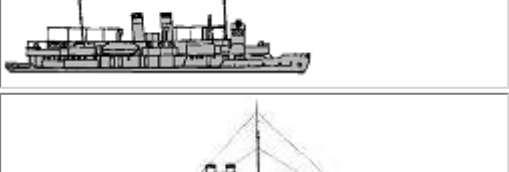
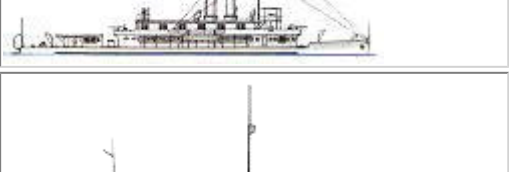
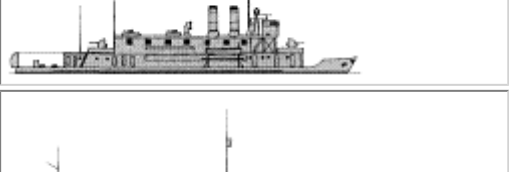
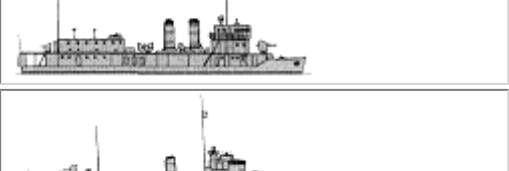
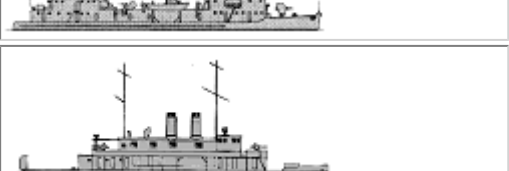
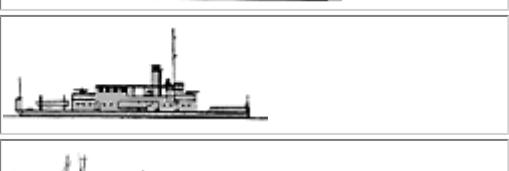

FF	Flower	2	2	Linyi	1940		1170t, 62.5x10.1x4.1m, 2b,1vte, 2750hp, 16.5kts, 109p; 2x1-100/56, 1x1-45/68(1), 4x1-37/73(1), 2x1-37/73(2)
	Ukuru	1	218	Huian	1944		1020t, 78.8x9.1x3.1m, 2d, 4200hp, 19.5kts, 150p; (1x2+1x1)-120/45, (5x3+5x1)-25/60, 1x1-81/12 ASWM, 12dct; 22-go, 13-go radars, sonar
	Castle	2	2	602 ex-Shihlin	1944		1630t, 76.8x11.2x4.2m, 2b,1vte, 2750hp, 16.5kts, 120p; 2x1-130/51, 1x1-45/69, 5x1-37/73; type 276, 291 radars, sonar
	pr. 50	4	205 206 207 208	Kunming Chengdu Guiyang Henyang	1957 1957 1958 1958		1337t, 90.9x10.2x2.9m, 2b,2gst, 20000hp, 29kts, 168p; 3x1-100/56, 2x2-37/70, 1x2-533TT, 2x24 MBU-200 ASWRL, 4dct, 2dcr; Giuys-1M4, Lin', Yakor' radars, Pegas-2M sonar, Bizan'-4 ECM
FS	D	4	215	Wuchang	1944		940t, 69.5x8.6x3.1m, 2b,1gst, 2500hp, 17.5kts, 160p; 2x1-120/45, (2x3+2x2+4x1)-25/60, 1x1-81/12 ASWM, 12dct; 22-go, 13-go radars
			216	Changsha	1944		
			219	Weihai	1945		
			220	Xian	1945		
	C	1	1	Shengyang	1945		810t, 67.5x8.4x2.9m, 2d, 1900hp, 16.5kts, 136p; 2x1-76/50, 2x3-25/60, 12dct; 22-go, 13-go radars
Bathurst	1	53	Loyang	1941		790t, 56.7x9.5x3.0m, 2b,2vte, 2000hp, 16kts, 90p; 2x1-100/56, 2x2-37/70; radar	

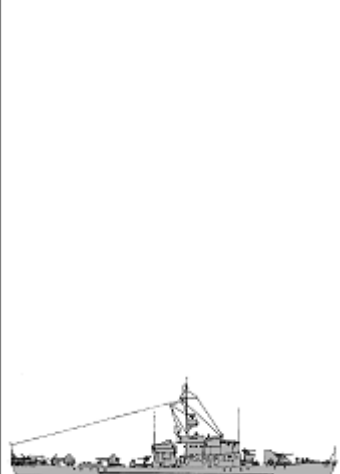
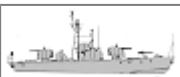

PATROL AND COASTAL COMBATANTS

PC	2	1	ex-PC593	1943		463t, 52.9x7.1x3.3m, 2d, 2880hp, 19kts, 65p; 2x1-76/55, 3x1-37/73, 2dct, 2dcr; SU radar, sonar
		2	ex-PC595	1943		
PGM	3	1	Tungping	1945		463t, 52.9x7.1x3.3m, 2d, 2880hp, 19kts, 65p; 2x1-76/55, 3x1-37/73, 2dct, 2dcr; SU radar, sonar
		2	ex-PGM14	1945		
		3	Kantang	1945		
Isles	2	1	ex-Chunghai	1941		770t, 50.0x8.4x3.4m, 1b,1vte, 850hp, 12.2kts, 40p; 1x1-76/40, 3x1-20/70, 4dct, 2dcr, sweeps
		2	ex-Sunghwei	1941		
Basset	1	1	Sungming	1938		775t, 50.0x8.4x3.4m, 1b,1vte, 950hp, 13kts, 33p; 1x1-102/40, 3x1-20/70, 2dct, 2dcr, sweeps



							
	Kiangyuan	1	1	Kiangyuan	1905		565t, 54.1x8.5x2.1m, 2b,2vte, 950hp, 13kts, 85p; 1x1-120/40, 1x1-76/40, 4x1-47/40
	Chuyu	1	1	Chutung	1906		752t, 61.0x9.0x2.4m, 2b,2vte, 1350hp, 13kts, 117p; 2x1-120/40, 2x1-76/40
PC	Yungchien	2	1	Yenan	1915		1039t, 65.7x9.0x3.5m, 2b,2vte, 1350hp, 13kts, 105p; 25deck; 1x1-102/50(2), 2x1-76/40(1), 1x1-76/40(2), 4x1-47/40(2), 2x1-37/27(2)
			2	Haihsing	1916		
	Yungsui	1	1	Yungsui	1929		800t, 70.0x9.1x1.8m, 2b,2vte, 4000hp, 18.5kts, 100p; 1x1-152/50, 1x1-120/45, 3x1-76/40, 4x1-57/40, 1x1-40/39
	Mingchuen	1	53	Zhangjiang	1930		500t, 61.8x7.9x1.8m, 2b,2vte, 2400hp, 16.6kts, 146p; 1x1-120/45, 1x1-102/45, 1x1-76/40, 2x1-57/40, 1x1-47/40
	Ataka	1	1	Antung	1923		1094t, 71.7x9.8x2.3m, 2b,2vte, 1700hp, 16kts, 118p; 2x1-76/40, 5x1-25/60, 3x2-13.2
	Uji	1	53	Nanchang	1941		1110t, 80.5x9.7x2.5m, 2b,2gst, 4600hp, 19.5kts, 170p; 2x1-130/51, 6x1-37/73
	Ruijin	5	1	Xingguo	1940s	No picture	704t, 55.0x10.0x3.0m, 2d, 500hp, 12kts, 100p; 1x1-105/22, 2x1-76/50, 2x2-37/83, 4x2-25/60
2			Zunyi	1940s			
3			Handan	1940s			
4			Huaiyang	1940s			
5			Yancheng	1940s			
	Gannet	1	1	Yingshan	1928		400t, 56.4x8.8x1.3m, 2b,2gst, 2250hp, 16kts, 55p; 2x1-76/45

PCR							
	Falcon	1	1	Yingteh	1931		470t, 45.7x8.8x1.8m, 2b,2gst, 2250hp, 15kts, 55p; 1x1-87/13, 2x1-57/40
	Sandpiper	1	1	Yinghao	1933		215t, 51.0x9.4x0.6m, 1b,2vte, 600hp, 11.2kts, 35p; 1x1-87/13, 1x1-57/40
	Wake	2	1	Meiyuan	1928		395t, 48.6x8.3x1.6m, 2b,2vte, 1950hp, 14.5kts, 70p; 2x1-76/50
			2	Taiyuan	1927		
	Toba	1	1	Hohseuh	1911		291t, 55.9x8.2x0.8m, 2b,3vte, 1400hp, 15kts, 59p; 2x1-76/40, 3x1-25/60
	Seta	1	1	Changteh	1923		400t, 56.1x8.2x1.0m, 2b,2vte, 2100hp, 16kts, 62p; 2x1-76/40, 5x1-13.2
	Atami	2	1	Yungping	1929		249t, 46.3x6.3x0.9m, 2b,2vte, 1300hp, 16.7kts, 77p; 3x1-76/40, 3x1-25/60, 3x1-13.2
			2	Yungan	1930		
	Fushimi	2	1	Chiangfeng	1939		368t, 50.3x9.8x1.3m, 2b,2gst, 2200hp, 17kts, 64p; 1x1-76/40, 1x1-25/60
2			Nanchang	1940			
Ermanno Carlotto	1	1	Kiangkun	1921		218t, 48.8x7.5x0.9m, 2b,2vte, 14kts, 44p; 2x1-76/40	
Macau	1	1	Wufeng	1909		133t, 36.5x6.0x0.7m, 1b,2vte, 250hp, 11.8kts, 24p; 2x1-57/40	
PT	pr. 123K	84	1-84		1951-1955		23t, 19.3x3.4x0.8m, 2d, 2000hp, 50kts, 7p; 1x2-14.5, 2-450TT, 6dc; Zarnitsa radar
	pr. 183	12	1-12		1951-1952		67t, 25.5x6.2x1.2m, 4d, 4800hp, 43kts, 14p; 2x2-25/112, 2-533TT, 8dc; Zarnitsa radar
	pr. 123K Chinese	50	1-50		1952-1959		23t, 19.3x3.4x0.8m, 2d, 2000hp, 50kts, 7p; 1x2-14.5, 2-450TT, 6dc; Zarnitsa radar

	pr. 183 Chinese	30	1-30		1956-1959		67t, 25.5x6.2x1.2m, 4d, 4800hp, 43kts, 14p; 2x2-25/112, 2-533TT, 8dc; Zarnitsa radar
PB	Yue 22	1	1	Haixin	1937		60t, 28.0x4.3x1.5m, 3pe, 3300hp, 33kts, 12p; 1x1-20/65
	pr. 122a	6	1		1945		250t, 50.4x5.8x2.0m, 3d, 3600hp, 21kts, 54p; 1x1-85/52, 2x1-37/73, 2x2-12.7, 2dct, 1dcr; Tamir-1 sonar
			2		1946		
			3		1946		
			4		1946		
			5		1946		
			6		1946		
	pr. 122-bis	20	611	Sizhou	1952		325t, 51.7x6.6x2.2m, 3d, 3300hp, 20kts, 54p; 1x1-85/52, 2x1-37/73, 3x2-14.5(ex-611-616), 2x2-12.7(611-616), 2x5 RBU-1200 ASWRL (ex-611-616), 2dct(611-616), 2dcr, 18mines; Giuys or Zarnitsa radar, Tamir-9/10/11 sonar
			612	Kiaozhou	1952		
			613	Changzhou	1953		
			614	Tungzhou	1953		
			615	Wengzhou	1953		
			616	Taizhou	1953		
			257		1956		
			258		1956		
262				1957			
263				1957			
630				1957			
633				1957			
634				1957			
635				1957			
651				1957			
652				1957			
653				1957			
654				1957			
655		1957					
656		1957					
	type 55A	61	1-61		1956-1959		85t, 25.7x6.0x1.8m, 4d, 4800hp, 28kts, 17p; 2x2-37/63, 2x1-12.7, 8dc; Reya or Zarnitsa radar
	Behai	30	1-30		1953-1954		80t, 27.5xxm, 3d, 900hp, 18kts; 2x2-25/80
	Taishan	4	1-4		1955		60t, 29.0xxm, d; 2x1-37/73, 2x1-12.7
	type 062	5	1		1959		120t, 35.1x5.5x1.6m, 4d, 4800hp, 28kts, 25p; 1x2-57/62, 1x2-37/63, 1x2-450TT(some), 8dc, 10mines; Reya radar, Tamir-11 sonar
2				1959			
3				1959			
4				1959			
5				1959			

PBR	type 53A	82	1-82		1950-1955		50t, 27.0x4.0x1.5m, 2d, 1000hp, 14kts; 2x2-25/82
	Fujian	30	1-30		1952-1958		20.0xxm, d; 2x1-12.7

AMPHIBIOUS

LST	LST(2)	14	341?	Chanbaishan	1942		4080t, 100.0x15.2x4.3m, 2d, 1800hp, 12.1kts, 125p; 2x1-76/50, 3x2-37/63, 3x1-37/73; 4 LCVP, 20tanks, 163troops; radar
			342?	Takushan	1943		
			343?	Wugongshan	1944		
			351?	Taihashan	1944		
			355?	Dabieshan	1944		
			901?	ex-Chung 107	1944		
			902?	Luliangshan	1945		
			903?	Tiangmushan	1944		
			921?	Yimengshan	1944		
			922?	Soraishan	1944		
			923?	Dahushan	1944		
			924?	Simingshan	1944		
			925?	Jinggangshan	1944		
			926?	ex-Chungye	1944		
LSM	LSM	14	352?	Yongming	1944		1095t, 62.0x10.5x2.1m, 2d, 2800hp, 13kts, 60p; 2x2-37/63; 5tanks, 54troops; radar
			353?	Meijian	1944		
			354?	Meile	1945		
			393?	Meicheng	1945		
			394?	Meiping	1945		
			395?	Meiwei	1945		
			396?	Meihan	1945		
			511?	Meigong	1945		
			931?		1944		
			932?		1944		
			933?		1944		
			934?		1944		
			935?		1944		
			936?		1944		
LCT(6)		10	1		1943		320t, 36.3x10.0x1.2m, 3d, 675hp, 8kts, 13p; 2x1-20/70; 4tanks
			2		1944		
			3		1944		
			4		1944		
			5		1944		
			6		1944		

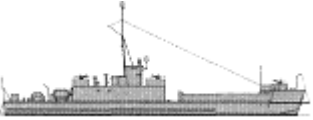
LCU			7		1944			
			8		1944			
			9		1944			
			10		1944			
	LCI(L)	14	301?		1943			385t, 48.9x7.2x1.6m, 2d, 2320hp, 15.5kts, 29p; 5x1-20/70; 209troops; radar
			302?		1943			
			303?		1943			
			304?		1943			
			305?		1943			
			306?		1943			
			307?		1943			
			308?		1943			
			309?		1944			
			310?		1944			
311?		1944						
312?		1944						
313?		1944						
314?		1944						
LC	type 336A	30?	1-30?		1956	No picture	63t, 17.1x4.5x1.8m, 2d, 300hp, 10kts; 2x1-12.7; 60troops	
	type 55	300	1-300		1957-1959	No picture	63t, 17.1x4.5x1.8m, 2d, 300hp, 10kts; 2x1-12.7; 60troops	
	type 066	1	1		1959	No picture	85t, 24.8x5.2x1.3m, 2d, 600hp, 11.5kts, 12p; 1x2-14.5; 150troops	

MINE WARFARE

ML	Tunghsi	2	1	Tunghsi	1949	No picture	500t, 52.0x9.7x3.3m, 2vte, 2000hp, 13kts; 1x1-76/50, 4x1-47/40, mines
			2	Tungteh	1949		
MSO	pr. 254K	2	366		1948		569t, 58.0x8.5x2.3m, 2d, 2200hp, 14kts, 65p; 2x2-37/70, 4x2-12.7, 2dct, 2dcr, 16mines, mechanical, acoustic, magnetic sweeps; Rif, Neptun radars, Tamir-10 sonar
			367		1949		
	type 6605	4	341?		1956		577t, 58.0x8.5x2.3m, 2d, 2200hp, 14kts, 68p; 2x2-37/63, 4x2-12.7, 2dct, 2dcr, 16mines, mechanical, acoustic, magnetic sweeps; Lin', Rym-K radars, Tamir-10 sonar
			342?		1957		
			362?		1957		
			363?		1957		
	type 6610	3	364		1958		590t, 60.0x8.6x2.2m, 2d, 2200hp, 14kts, 70p; 2x2-37/63, 2x2-25/80, 2x2-12.7, 2dct, 2dcr, 16mines, mechanical, acoustic, magnetic sweeps; Lin' radar, Tamir-11 sonar
			375		1959		
			376		1959		

MSC	YMS	5	1	ex-BYMS2017	1942		320t, 41.5x7.5x2.4m, 2d, 800hp, 14kts, 60p; 1x1-76/50, 2x1-20/70, 2dct, 2dcr, sweeps; radar
			2	ex-YMS339	1943		
			3	ex-YMS346	1943		
			4	ex-YMS367	1943		
			5	ex-YMS393	1943		
MSI	Wa1	2	200	ex-No4	1942		222t, 33.0x5.9x2.3m, 1d, 300hp, 9.5kts, 43p; 1x1-76/23, 4x1-25/60, sweeps, 1dcr
			201	ex-No14	1943		

© Ivan Gogin, 2015

[home](#)[World navies yesterday](#)[1960](#)

Colombia 01 January 1960

PRINCIPAL SURFACE COMBATANTS

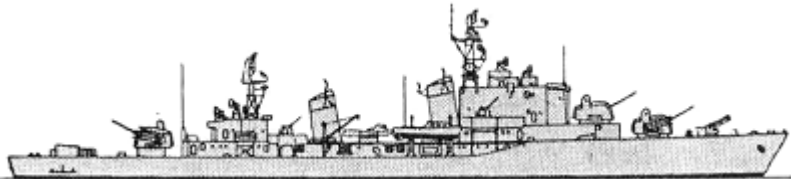
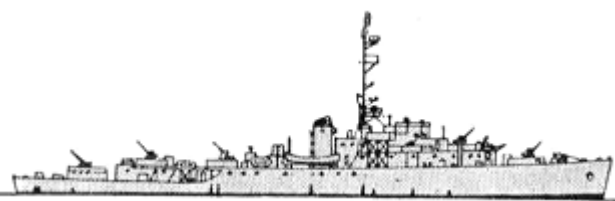
DD	Lima	2	D01	Antioquia	1934		1563t, 98.5x9.4x2.7m, 3b,2gst, 33000hp, 36kts, 147p; 2x1-127/38, 6x1-40/60, 1x4-533TT, 1x24-178 Hedgehog ASWRL, 20mines, 6dct; radar, sonar
			D02	Caldas	1934		
DD	20 de Julio	2	D05	20 de Julio	1958		3300t, 121.1x12.4x4.7m, 2b,2gst, 55000hp, 32kts, 248p; 3x2-120/50, 4x1-40/70, 1x4-533TT, 1x4-375 M50 ASWRL, 2x6-103 RFL; LW-03, DA-02, 4x M45 radars, sonars
			D06	7 de Agosto	1958		
FF	Tacoma	3	FG11	Almirante Padilla	1944		2238t, 92.6x11.4x3.9m, 3b,2vte, 5500hp, 20kts, 190p; 3x1-76/50, 2x2-40/60, 9x1-20/70, 1x24-178 Hedgehog ASWRL, 8dct, 2dcr; SA, SF, Mk26 radars, sonar
			FG12	Almirante Tono	1944		
			FG13	Almirante Brión	1944		

PATROL AND COASTAL COMBATANTS

PC	Carabobo	3	1	Carabobo	1925	No picture	120t, 33.0x6.0x2.5m, 1b,1vte, 300hp, 13kts, 37p; 1x1-75/35, 1x1-20/70
			2	Junin	1925		
			3	Pichincha	1925		
APC	-	1	1	Mariscal Sucre	1909		125t; 2x1-76/40
PB	Diligente	10	LR121	Diligente	1952	No picture	33t, 23.2x3.7x0.8m, 2d, 280hp, 13kts, 10p; 2x1-20/70
			LR122	Juan Lucio	1953		
			LR123	Alfonso Vargas	1952		
			LR124	Fritz Hagale	1952		
			LR125	Alberto Restrepo	1954		
			LR126	Humberto Cortés	1953		
			LR127	Calibio	1953		
			LR128	Carlos Galindo	1954		
			LR129	Valerosa	1954		

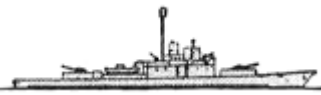
			LR130	Luchadora	1954		
PR	Cartagena	3	CF31	Barranquilla	1931		142t, 41.8x7.2x0.8m, 2sd, 600hp, 15.5kts, 39p; 1x1-76/40, 1x1-20/70
			CF32	Santa Marta	1931		
			CF33	Cartagena	1931		
	Río Hacha	3	CF35	Río Hacha	1956		184t, 49.8x8.2x1.0m, 2d, 916hp, 13kts, 43p; 2x1-76/50, 4x1-20/70
			CF36	Leticia	1956		
			CF37	Arauca	1956		
APR	-	3	1	Presidente Mosquera	1912		230t; 1x1-76/40
			2	Demetrio Salamanca			120t
			3	Fernández Madrid			150t

COAST GUARD

PC	General Rafael Reyes	2	AN01	General Rafael Reyes	1956		146t, 38.0x7.0x1.5m, 2d, 2500hp, 18kts, 20p; 1x1-40/60
			AN02	General Vasques Cobo	1956		
PB	Espartana	1	GC100	Espartana	1950	No picture	50t, 29.3x4.1x1.2m, 2d, 300hp, 13.5kts; 1x1-20/70
	Capitán R. D. Binney	1	GC101	Capitán R. D. Binney	1947	No picture	23t, 20.4x3.3x1.1m, 2d, 115hp, 13kts

© Ivan Gogin, 2016

[home](#)

[World navies yesterday](#)

[1960](#)

Costa Rica 01 January 1960

COAST GUARD

PB	US 40ft	3	401-403		1955-58	No picture	10t, 12.5x3.1x0.7m
----	---------	---	---------	--	---------	------------	--------------------

© Ivan Gogin, 2016



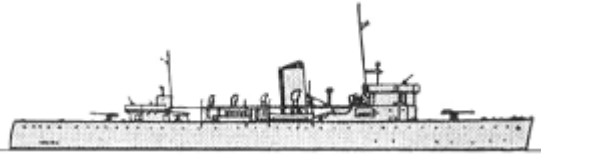
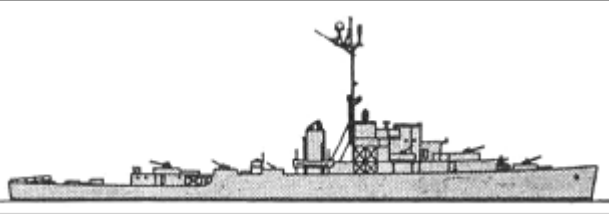

[home](#)[World navies yesterday](#)[1960](#)

Cuba 01 January 1960

PRINCIPAL SURFACE COMBATANTS

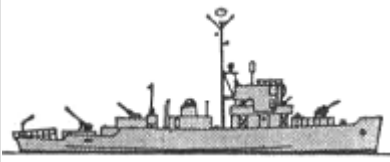
	Cuba	1	1	Cuba	1911		2055t, 79.2x11.9x4.3m, 2b,2vte, 6000hp, 18kts, 145p; 2x1-102/50, 2x1-76/50, 2x1-76/23, 6x1-57/40, 2dct; radar
FF	Tacoma	3	F301	José Martí	1944		2238t, 92.6x11.4x3.9m, 3b,2vte, 5500hp, 20kts, 190p; 3x1-76/50, 2x2-40/60, 9x1-20/70, 1x24-178 Hedgehog ASWRL, 8dct, 2dcr; SA, Mk26 radars, sonar
			F302	Antonio Maceo	1945		
			F303	Máximo Gómez	1944		

PATROL AND COASTAL COMBATANTS

PSO	PCE	2	PCE301	Caribe	1943		903t, 56.2x10.1x2.9m, 2d, 2000hp, 15.1kts, 96p; 1x1-76/50, 3x2-40/60, 4x1-20/70, 1x24-178 Hedgehog ASWRL, 4dct, 2dcr; SO radar, sonar
			PCE302	Siboney	1944		
PC	PC451	1	PE303	Baire	1944		463t, 52.9x7.1x3.3m, 2d, 2880hp, 20kts, 65p; 1x1-76/50, 1x1-40/60, 3x1-20/70, 2x4-178 Mousetrap ASWRL, 2dct, 2dcr; SO radar, sonar
PB	USCG 83ft	12	GC11-14, 21-24, 31-34	-	1942-1943		45t, 25.3x4.9x1.4m, 2pe, 1200hp, 20.5kts, 10p; 1x1-20/70, 2x4-178 Mousetrap ASWRL, 4dcr; radar, sonar
	Leoncio Prado	1	GC101	Leoncio Prado	1946	No picture	80t, 33.5x4.4x2.0m, 2d, 1000hp, 15.9kts; 1x1-20/70, 2dcr; radar
	SC110	5	GC104	Oriente	1943		136t, 33.8x5.5x2.0m, 2d, 1000hp, 16kts, 27p; 1x1-40/60, 3x1-20/70, 2x4-178 Mousetrap ASWRL, 2dct, 2dcr; radar, QC sonar
			GC105	Camaguey	1943		
			GC106	Las Villas	1943		
GC107			Habana	1943			
	GC108	Pinar del Río	1943				
	Matanzas	1	1	Matanzas	1912	No picture	80t, 30.5x5.5x1.3m, 1b,1vte, 200hp, 12kts, 20p; 1x1-37/40

Capitán Fernández
Quevedo

1

GC102

Donativo

1932

No picture

130t, 30.8x5.5x2.1m, 2d, 300hp, 12kts, 21p; 2x1-37/40

© Ivan Gogin, 2016





[home](#)[World navies yesterday](#)[1960](#)

Denmark 01 January 1960

SUBMARINES

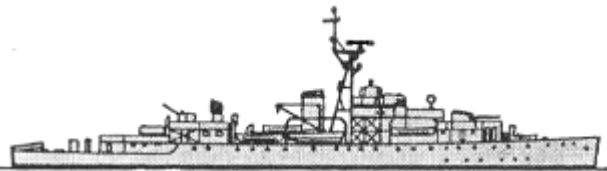

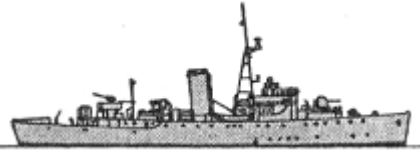
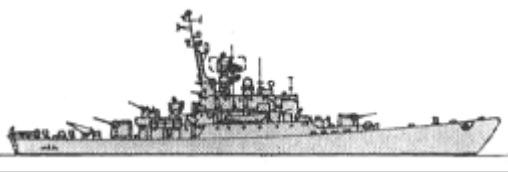

SS	Delfinen	2	S326	Delfinen	1958		595/643t, 54.5x4.7x4.0m, 2d/em, 1200/1200hp, 15/15kts, 33p, 100m; 4-533TT; radar, sonars
			S327	Spækhuggeren	1959		

PRINCIPAL SURFACE COMBATANTS



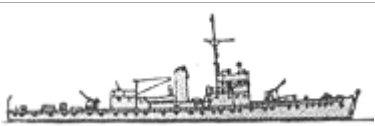

FF	River	1	F339	Niels Ebbesen	1944		2180t, 91.8x11.2x3.9m, 2b,2vte, 5500hp, 20kts, 140p; 2x1-127/38, 4x1-40/60, 4x1-20/70, 1x24-178 Hedgehog ASWRL, 4dct, 2dcr; type 271, 291 radars, sonars
	Hunt batch 2	3	F341	Esbern Snare	1942		1625t, 85.3x9.6x3.8m, 2b,2gst, 19000hp, 27kts, 168p; 3x2-102/45, 4x1-40/60, 4dct, 2dcr; type 271, 285, 290 radars, type 123A, 127 sonars
			F342	Rolf Krake	1941		
F343	Valdemar Sejr	1941					
FS	Flower	1	F340	Thetis	1940		1170t, 62.5x10.1x4.1m, 2b,1vte, 2750hp, 16.5kts, 109p; 1x1-102/45, 1x1-40/60, 2x1-20/70, 1x24-178 Hedgehog ASWRL, 4dct, 2dcr; type 286, 290 radars, sonar
	Bellona	4	F344	Bellona	1957		900t, 79.0x9.6x3.0m, 2d, 4400hp, 20kts, 200p; 2x1-76/62, 1x2-40/70, 2x24-178 Hedgehog ASWRL, 4dct, 1dcr; NWS-1, CWS-1 radars, QCU-2 sonar
			F345	Diana	1955		
			F346	Flora	1956		
			F347	Triton	1955		
Huitfeldt	2	P520	Huitfeldt	1947			
		P521	Willemoes	1947			

PATROL AND COASTAL COMBATANTS

PC	Søløven	2	P577	Søhunden	1942		304t, 53.6x6.4x2.0m, 1b, 1gst, 2200hp, 19.5kts, 48p; 2x1-40/60, 2x1-20/70, 4dct, 30mines

			P579	Søridderen	1942		
PT	S300	3	P551	Glenten	1946		124t, 34.9x5.3x1.7m, 3d, 9000hp, 443.6kts, 45p; 1x1-40/70, 1x1-20/70, 2-533TT, 2dcr, 6mines
			P557	Jagtfalken	1945		
			P565	Falken	1945		
	S38	6	P552	Gribben	1941		115t, 34.9x5.3x1.7m, 3d, 6000(52)-7500(54,56)hp, 39(52)-41(54,56)kts, 45p; 1x1-40/70, 1x1-20/70, 2-533TT, 2dcr, 6mines
			P560	Ravnen	1943		
			P562	Stormfuglen	1941		
			P564	Tranen	1942		
			P566	Hejren	1942		
			P568	Viben	1942		
	S139	2	P561	Skaden	1944		122t, 34.9x5.3x1.7m, 3d, 7500hp, 41kts, 31p; 1x1-40/70, 1x1-20/70, 2-533TT, 2dcr, 6mines
			P567	Lommen	1944		
	Flyvefisken	6	P500	Flyvefisken	1954		132t, 36.6x5.5x1.8m, 3d, 7500hp, 40kts, 23p; 1x1-40/70, 1x1-20/70, 2-533TT; radar
			P501	Hajen	1955		
			P502	Havkatten	1955		
			P503	Laxen	1955		
P504			Makrelen	1955			
P505			Sværdfisken	1955			

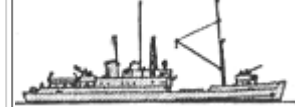
MINE WARFARE

ML	Lindormen	1	N39	Lindormen	1940		645t, 53.5x8.8x2.4m, 2b,2vte, 1200hp, 66p; 4x1-40/70, 138mines
	Lougen	2	N40	Laaland	1941		350t, 34.2x6.6x2.2m, 2d, 350hp, 11kts, 32p; 2x1-20/60, 18mines
			N41	Lougen	1941		
	Langeland	1	N42	Langeland	1951		330t, 44.0x7.2x2.2m, 2d, 770hp, 12kts, 37p; 2x1-40/70, 2x1-20/70, mines; radar
	LSM	2	N50	Beskytteren	1945		1095t, 62.0x10.5x2.6m, 2d, 2800hp, 13kts, 70p; 4x2-40/60, 400mines; radar
N51			Vindhunden	1945			
MSC	Bluebird	8	M571	Aarøsund	1955		400t, 44.3x8.1x2.1m, 2d, 1200hp, 13kts, 39p; 1x1-40/60, mechanical, acoustic, magnetic minesweeping gear; NWS-3 radar, UQS-1 sonar
		M572	Alssund	1955			
		M573	Egernsund	1955			
		M574	Grønsund	1956			

			M575	Guldborgsund	1956		
			M576	Omø Sund	1956		
			M577	Ulvsund	1956		
			M578	Vilsund	1956		
MSI	R151	5	M547	Asnæs	1940		126t, 35.4x5.6x1.5m, 2d, 1800hp, 23.5kts, 31p; 1x1-37/83, (2x2+1x1)-20/65, 2dcr, 10mines, minesweeping gear
			M550	Egenæs	1940		
			M551	Helgenæs	1941		
			M552	Lynæs	1941		
			M553	Rinkenæs	1941		
	R218	3	M554	Stignæs	1944		148t, 39.4x5.7x1.6m, 2d, 2500hp, 21kts, 40p; 1x1-37/83, 3x2-20/65, 12mines, minesweeping gear, 2dcr
M555	Trellenæs		1944				
M556	Vornæs		1944				
MSB	MS1	7	M560	Askø	1941		74t, 24.4x4.6x1.5m, 1d, 250hp, 11kts, 11p; 1x1-20/70, minesweeping gear
			M561	Baagø	1941		
			M562	Enø	1941		
			M563	Fænø	1941		
			M564	Hjortø	1941		
			M565	Lyø	1941		
			M566	Manø	1941		
	ML1	2	M569	Klørdyb	1946	No picture	21t, 15.2x4.2x1.3m, 1d; minesweeping gear
M570	Vejdyb		1947				

HOME GUARD

PB	DMH70	3	DMH70		1958	No picture	130t, 20.1x5.1x2.5m, 1d, 200hp, 10kts, 6p; NWS-3 radar
			DMH71		1958		
			DMH72		1958		

FISHERY PROTECTION

PC	Freja	1	A541	Freja	1939		342t, 40.9x7.7x2.2m, 1b,1vte, 255hp, 10.5kts, 40p; 2x1-20/70
PB	MSK1	3	Y369	Alholm	1945	No picture	70t, 20.0x5.1x2.3m, 1d, 120hp, 10kts; 1x1-20/60
			Y370	Birkholm	1945		
			Y371	Ertholm	1945		
	MSK4	3	Y372	Fyrholm	1945	No picture	72t, 21.0x5.2x2.7m, 1d, 120hp, 10kts; 1x1-20/60
			Y373	Græsholm	1945		
			Y374	Lindholm	1945		
			Y382	Skarven	1952		

	Skarven	2	Y383	Teisten	1952	No picture	143t, 25.2x6.3x3.1m, 1d, 180hp, 9kts, 11p; 1x1-37/20
--	---------	---	------	---------	------	------------	--

© Ivan Gogin, 2016

[home](#)[World navies yesterday](#)[1960](#)

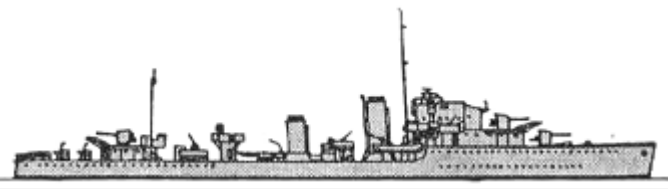
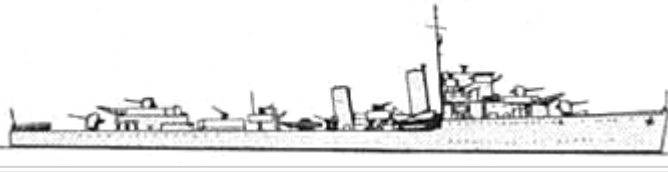
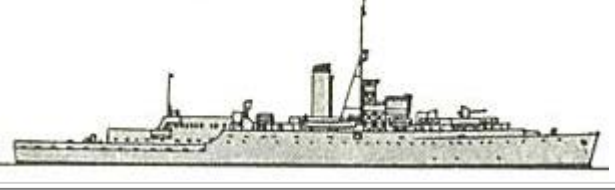
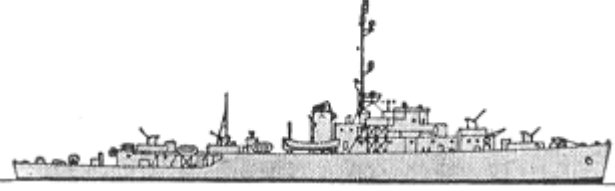
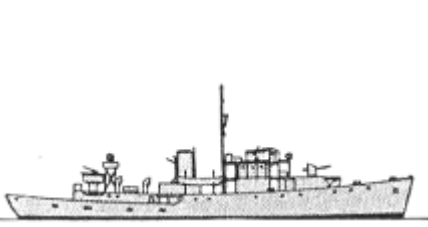

Dominican Republic 01 January 1960

PRINCIPAL SURFACE COMBATANTS

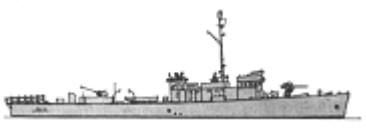

DD	H	1	D101	Trujillo	1936		2095t, 98.5x10.1x4.1m, 3b,2gst, 34000hp, 36kts, 145p; 3x1-120/45, (2x2+2x1)-20/70, 1x4-533TT, 4dct, 1dcr, minesweeping gear; radars, type 124 sonar
	F	1	D102	Generalissimo	1935		2095t, 100.3x10.1x4.0m, 3b,2gst, 36000hp, 36kts, 145p; 4x1-120/45, (2x2+2x1)-20/70, 4dct, 1dcr, minesweeping gear; radars, type 121 sonar
FF	River	1	F101	Presidente Trujillo	1944		2125t, 91.8x11.2x3.9m, 2b,2vte, 5500hp, 20kts, 195p; 1x1-102/41, 2x1-47/40, 1x1-40/60, 4x1-20/70; radar
	Tacoma	2	F103 F104	Presidente Troncoso Presidente Peynado	1944 1944		2238t, 92.6x11.4x3.9m, 3b,2vte, 5500hp, 20kts, 190p; 3x1-76/50, 2x2-40/60, 6x1-20/70, 2x2-12.7; SA, SF, Mk26 radars
FS	mod. Flower	5	C101	Cristobal Colón	1944		1350t, 63.5x10.1x4.4m, 2b,1vte, 2750hp, 16.5kts, 109p; 1x1-102/40, 1x1-40/60, 2x1-20/70, 1x24-178 Hedgehog ASWRL, 4dct, 2dcr; type 268, 276 radars, sonar
			C102	Juan Alejandro Acosta	1943		
			C103	Juan Bautista Cambiaso	1944		
			C104	Gerardo Jansen	1944		
			C105	Juan Bautista Maggiolo	1943		

PATROL AND COASTAL COMBATANTS

		P101	27 de Febrero	1943	
--	--	------	---------------	------	--

PC	PC173	3	P102	Capitán Wenceslao Arvelo	1943		463t, 52.9x7.1x3.3m, 2d, 2880(101,102)-1800(103)hp, 19(101,102)-17(103)kts, 65p; 1x1-76/50, 1x1-40/60, 1x1-20/70; SO radar
			P103	Cibas	1942		
			P104	Restauración	1933		
	Argo	3	P105	Independencia	1932		370t, 50.3x7.2x2.3m, 2d, 1340hp, 16kts, 50p; 1x1-76/50, 1x1-40/60, 1x1-20/70; radar
			P106	Rafael Atoa	1931		
			GC75ft	5	GC3-7		
PB	GC2	1	GC2		1918	No picture	18t, 13.7x3.4x1.1m, 2pe, 200hp, 9.5kts
			GC8		1941	No picture	28t, 19.0x3.7x1.2m, 1pe, 200hp, 10kts, 10p
			GC9	Luperón	1943	No picture	45t, 25.3x4.9x1.4m, 2pe, 1200hp, 20.5kts, 14p; 2x1-20/70, 2dcr
	GC10	22 de Julio	1943				
	GC11	16 de Agosto	1943				
	AVR	2	GC105	Capitán Alsina	1945	No picture	100t, 31.9x5.9x1.7m, 2pe, 1000hp, 17kts, 20p; 2x1-20/70
			GC106	Capitán Maduro	1945		
	SC110	2	GC101	Sanchez	1943		136t, 33.8x5.5x2.0m, 2d, 1000hp, 16kts, 27p; 1x1-40/60, 3x1-20/70, 2x4-178 Mousetrap ASWRL, 2dct, 2dcr; SO radar, QC sonar
GC102			Mella	1943			

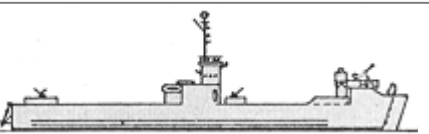
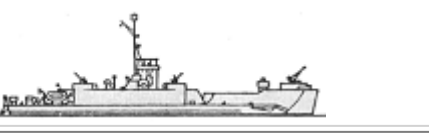
AMPHIBIOUS

LSM	LSM1	2	BA103	San Rafael	1944		1095t, 62.0x10.5x2.1m, 2d, 2800hp, 13.2kts, 60p; 1x2-40/60, 4x1-20/70; 5tanks, 54troops; radar
			BA104	Sirio	1945		
LCU	LCI(L)1	1	BDI103	Paraíso	1944		385t, 48.9x7.2x1.6m, 8d(2), 2320hp, 15.5kts, 29p; 3x1-20/70, 2x1-12.7; SO radar; 209troops(103)
			Samaná	2	LA2		
	LA3	17 de Julio			1958		310t, 36.4x11.0x0.9m, 3d, 441hp, 8kts, 17p; 1x1-12.7; 4tanks

© Ivan Gogin, 2016



[home](#)[World navies yesterday](#)[1960](#)

Ecuador 01 January 1960

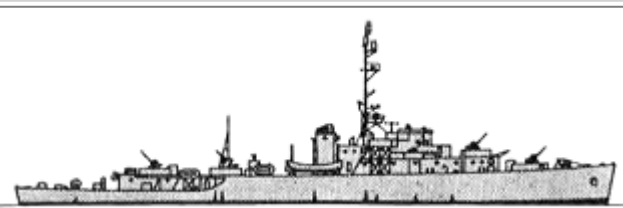
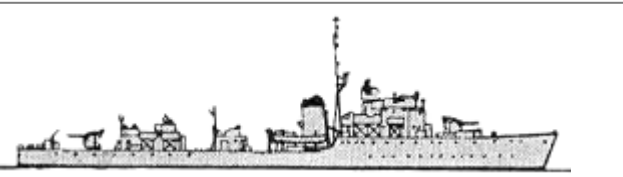
PRINCIPAL SURFACE COMBATANTS

FF	Tacoma	1	E01	Guayas	1944		2238t, 92.6x11.4x3.9m, 3b,2vte, 5500hp, 20kts, 190p; 3x1-76/50, 2x1-40/60, 4x1-20/70, 6dct, 2dcr; SA, SF, Mk26 radars, sonar
	Hunt batch 1	2	D01 D02	Presidente Alfaro Presidente Velasco Ibarra	1941 1940		1450t, 85.3x8.8x3.8m, 2b,2gst, 19000hp, 28kts, 147p; 2x2-102/45, 1x4-40/39, 2x1-20/70, 2dct, 1dcr; type285 radar, type 123A, 177 sonars

PATROL AND COASTAL COMBATANTS

APS	-	2	1	Abdón Calderón	1884		300t; 4x1-76/40
			2	Manabí	1922		590t; 2x1-76/50
PC	APc	1	1	El Oro	1943		234t, 31.4x6.5x2.8m, 1d, 400hp, 10kts, 25p; 4x1-20/70; 66troops
PB	LP7	6	LP7-12		1954	No picture	35t, 23.0x3.9x1.2m, 2d, 1000hp, 20kts, 8p
	LSP1	6	LSP1-6		1954-1955		64t, 23.4x4.6x1.8m, 2d, 1200hp, 22kts, 9p

AMPHIBIOUS

LSM	LSM1	2	T31	Jambelí	1945		1095t, 62.0x10.5x2.1m, 2d, 2800hp, 13kts, 60p; 1x2-40/60, 4x1-20/70; 5tanks, 54troops; radar
			T32	Tarqui	1945		

© Ivan Gogin, 2016

[home](#)[World navies yesterday](#)[1960](#)

Egypt 01 January 1960

SUBMARINES

SS	pr. 96	1	1	-	1950		280/351t, 49.5x4.4x2.8m, 2d/2em, 1200/430hp, 15.5/7.9kts, 23p, 60m; 4-533TT
	pr. 613	5	1	S1	1954		1045/1342t, 76.0x6.3x4.6m, 2d/em, 4000/2700hp, 18.3/13.1kts, 55p, 170m; 6-533TT; Flag radar, Tamir-5L, Feniks sonars, Nakat ECM
			2	S2	1954		
			3	S3	1954		
			4	S4	1955		
			5	S5	1954		

PRINCIPAL SURFACE COMBATANTS

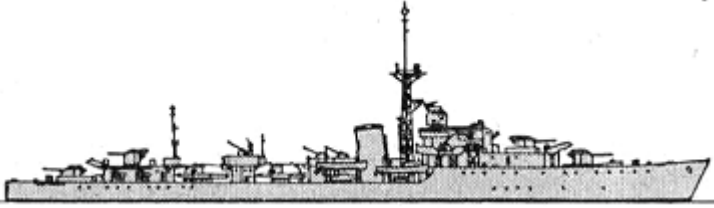
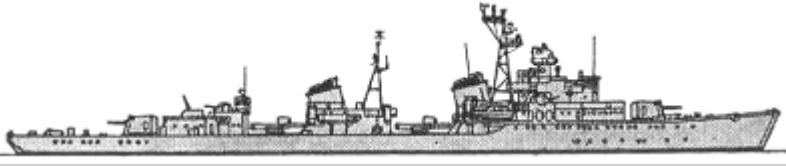
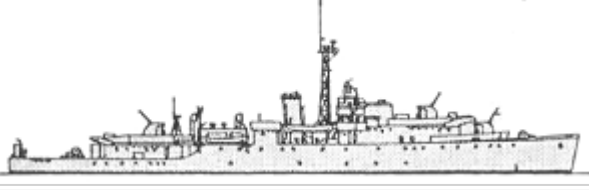
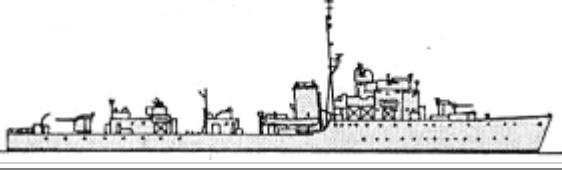
DD	Z	2	1	El Qaher	1944		2575t, 110.6x10.9x4.4m, 2b,2gst, 40000hp, 36.7kts, 222p; 4x1-114/45, (1x2+4x1)-40/60, 2x4-533TT, 4dct, 2dcr; type 275, 277, 293 radars, type 123A, 127 sonars
			2	El Fateh	1944		
	pr. 30bis	2	1	El Nasser	1952		3066t, 120.5x12.0x4.3m, 4b,2gst, 60000hp, 35.5kts, 286p; 2x2-130/51, 1x2-85/52, 4x2-37/70, 2x5-533TT, 6dct, 2dcr, 60mines; Giuys-1M, P-10, Rif-1, Rym-1, Zalp(1), Redan(2), Vympel-2, Zaria(1), Redan-4(2) radars, Tamir-5N sonar
			2	El Zaffer	1952		
FF	mod. Black Swan	1	42	Tariq	1943		1950t, 91.3x11.7x3.4m, 2b,2gst, 4300hp, 19.7kts, 192p; 3x2-102/45, 2x2-40/60, (2x2+2x1)-20/70, 8dct, 2dcr; type 272, 285, 291 radars, type 147, 177 sonars
	Hunt batch 1	1	11	Mohammed Ali	1940		1450t, 85.3x8.8x3.8m, 2b,2gst, 19000hp, 28kts, 147p; 2x2-102/45, (1x4+1x1)-40/39, 2x1-20/70, 2dct, 1dcr; type 285 radar, type 123A, 177 sonars

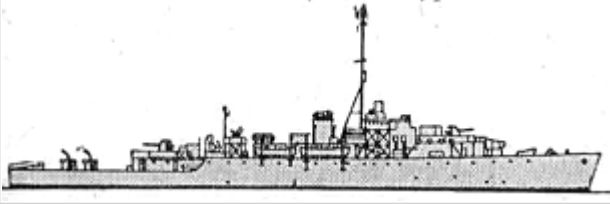
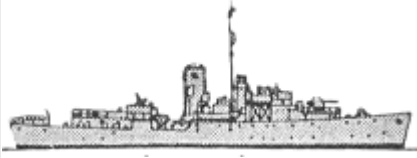
	River	1	43	Rashid	1942		2180t, 91.8x11.2x3.9m, 2b,2vte, 5500hp, 20kts, 140p; 2x1-102/40, 6x1-40/60, 1x24-178 Hedgehog ASWRL, 8dct, 2dcr; type 277, 291 radars, sonars
	Flower	1	1	As Sudan	1940		1170t, 62.5x10.1x4.1m, 2b,1vte, 2750hp, 16.5kts, 109p; 1x1-102/45, 1x1-40/39, 2x1-20/70, 2dct, 2dcr; type 286, 290 radars, sonar



PATROL AND COASTAL COMBATANTS

PT	Fairmile D	2	1	El Naser	1944		118t, 35.1x6.5x1.5m, 4pe, 4800hp, 29kts, 30p; 2x1-57/43, 1x2-20/70, 2x2-12.7, 4-450TT, 2dcr; type 286U radar
			2	El Zafer	1944		
	pr. 183	10	1-10		1949-1956		67t, 25.5x6.2x1.2m, 4d, 6000hp, 43kts, 14p; 2x2-25/80, 2-533TT, 2dcr; Zarnitsa radar
PB	Higgins	6	1-6		1943		54t, 24.8x6.1x1.6m, 3pe, 4050hp, 41kts, 17p; 1x1-40/60, 2x1-20/70, 2x2-12.7; SO radar
	Fairmile B	3	1	Hamza	1943		86t, 34.8x5.6x1.5m, 2pe, 1200hp, 18kts, 16p; 1x1-47/40, (1x2+1x1)-20/70, 2dcr; type 286 radar, sonar
			2	Sab El Bahr	1943		
3			Saker Al Bahar	1943			
PR	El Zafir	1	1	El Zafir	1896	No picture	128t, sw; 1x1-76/40

AMPHIBIOUS

LC	LCM(3)	18	1-18	-	1942-1945		52t, 15.3x4.3x1.4m, 2d, 330hp, 8kts, 4p; 2x1-12.7; 1tank or 60troops
----	--------	----	------	---	-----------	---	--

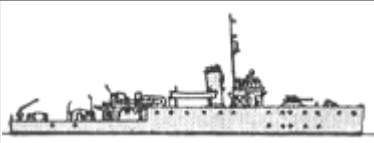
MINE WARFARE

MSO	Bangor	2	1	Matrouh	1941		875t, 54.9x8.7x3.1m, 2b,2vte, 2400hp, 16.5kts, 87p; 1x1-102/45, 1x1-76/45, 2x1-40/60, 2x1-20/70, 2dct; radar, sonar
			2	Nasr	1941		
	pr. 254K	4	304	Sharkiya	1954		
			305	Dakahliya	1954		
MSC	YMS	8	1	Arish	1942		577t, 58.0x8.5x2.3m, 2d, 2200hp, 14kts, 68p; 2x2-37/70, 4x2-12.7, 2dct, 2dcr, 16mines, mechanical, magnetic, acoustic minesweeping gear
			2	Malek Fuad	1943		
			3	Darfur	1943		
			4	Naharia	1943		
							250t, 41.5x7.5x2.4m, 2d, 800hp, 15kts, 60p; 1x1-76/50, 2x1-20/70, mechanical, acoustic, magnetic minesweeping gear; radar

5	Kaisaria	1943
6	Rafah	1943
7	Tor	1943
8	Kordofan	1943



© Ivan Gogin, 2016

[home](#)

[World navies yesterday](#)

[1960](#)

El Salvador 01 January 1960

COAST GUARD

PB	HDML	2	GC1, 2		1941-45		54t, 22.0x4.8x1.4m, 2d, 300hp, 11.8kts, 16p; 1x1-20/70
	US 40ft	2	GC3, 4		1950	No picture	11t, 12.3x3.4x1.0m, 2d, 400hp, 18kts; 1x1-12.7

© Ivan Gogin, 2016

[home](#)

[World navies yesterday](#)

[1960](#)

Ethiopia 01 January 1960

PATROL AND COASTAL COMBATANTS







PC	Cape	2	PC11	1958		146t, 29.0x5.8x1.6m, 4d(2), 2200hp, 21kts, 20p; 1x1-40/60, 1x1-12.7, 1x4-178 Mousetrap ASWRL; radar
			PC12	1958		

© Ivan Gogin, 2016

[home](#)[World navies yesterday](#)[1960](#)

Finland 01 January 1960

PATROL AND COASTAL COMBATANTS



PG	Baglietto 500	4	J1-4	Jylhä, Jyry, Jyske, Jymy	1939		25t, 18.7x4.6x1.5m, 2pe/2pe(2), 2300/100hp, 42kts, 10p; 1x1-20/65, 1x1-13.2
	H	5	H1-5	Hyöky, Hirmu, Hurja, Hyrsky, Häijy	1943		22t, 16.5x4.3x1.5m, 2pe/2pe(2), 1600/100hp, 36kts, 11p; 2x1-20/65, 2x1-13.2
	T	8	T1-8	Taisto 1-8	1943-1946		22t, 17.8x4.6x1.5m, 2pe, 2300hp, 48kts; 1x1-40/60, 2x1-13.2
	Vasama	2	V1, 2	Vasama 1, 2	1957		70t, 21.8x5.9x1.8m, 2d, 5000hp, 42kts, 20p; 2x1-40/70, 1dcr, mines; radar
PC	Rihtniemi	2	51	Rihtniemi	1957		110t, 31.0x5.6x1.8m, 2d, 2500hp, 15kts, 20p; 1x1-40/60, 1x1-20/70, 2x5 RBU-1200 ASWRL, sweeps; radar
			52	Rymättylä	1957		
	Ruissalo	3	53	Ruissalo	1959		130t, 32.0x6.0x1.8m, 2d, 2500hp, 15kts, 20p; 1x1-40/60, 1x1-20/70, 2x5 RBU-1200 ASWRL, sweeps; Decca radar, sonar
			54	Raisio	1959		
			55	Röyttä	1959		

AMPHIBIOUS

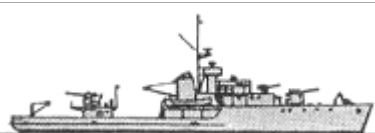
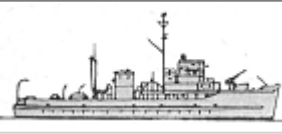

LCU	Kala	6	71	Kala 1	1956	No picture	200t, 27.0x8.0x1.8m, 2d, 360hp, 9kts, 10p; 2x1-12.7, 34mines or 120t cargo; Decca 1226 radar
			72	Kala 2	1957		
			73	Kala 3	1957		
			74	Kala 4	1958		
			75	Kala 5	1958		
			76	Kala 6	1959		
LCM	Kave	5	1-5	Kave 1-5	1956-1959	No picture	75t, 18.0x5.0x1.3m, 2d, 360hp, 9kts, 7p; 1x1-20/70; 40t of cargo

MINE WARFARE

ML	Ruotsinsalmi	1	1	Ruotsinsalmi	1941		370t, 50.0x7.9x1.5m, 2d, 1200hp, 15kts, 60p; 2x1-40/60, 2x1-20/70, 100mines, sweeps; radar
----	--------------	---	---	--------------	------	--	--

	Keihässalmi	1	05	Keihässalmi	1958		360t, 56.0x7.7x2.0m, 2d, 1600hp, 15kts, 60p; 2x1-40/70, 2x1-20/70, 100mines; Decca radar
MSC	YMS	2	1	Katanpää	1943		250t, 41.5x7.5x2.4m, 2d, 800hp, 15kts, 60p; 1x1-76/50, 2x1-20/70, sweeps; SO radar
			4	Tammenpää	1943		
MSI	Pukkio	3	1	Pukkio	1940	No picture	162t, 27.0x6.7x2.5m, 1d, 300hp, 10kts; 1x1-40/60, 1x1-20/70, 20mines
			2	Porkkala	1940		
			3	Pansio	1947		
MSB	Ahven	6	1-6	Ahven 1-6	1936-1937	No picture	17t, 17.2x3.8x1.3m, 1d, 65hp, 10kts, 8p; 1x1-20/60, sweeps
	Kuha	12	7-18	Kuha 2, 3, 5, 7-18	1945-1946		17t, 17.2x3.8x1.6m, 1d, 70hp, 9kts; 1x1-20/60, sweeps
	Ajonpää	2	1, 2	Ajonpää, Kallanpää	1941-1942	No picture	52t, 20.0x5.3x1.7m, 1d, 200hp, 10kts; 1x1-20/60, sweeps

COAST GUARD

PS	Tursas	1	1	Tursas	1933	No picture	400t, 40.0x7.2x4.3m, 1d, 620hp, 12kts; 1x1-76/50, 1x1-40/60, 2x1-20/70
	Uisko	1	1	Uisko	1959	No picture	370t, 43.0x7.3x3.9m, 1d, 1800hp, 15kts, 21p; 1x1-20/70; radar
PB	VMV5	2	VMV5, 6	-	1931	No picture	30t, 24.6x4.4x1.1m, 2pe/1pe(2), 900/140hp, 24.6kts, 8p; 1x1-20/60
	VMV8	5	VMV9, 11, 13, 15, 16	-	1935		31t, 25.6x4.4x1.0m, 2sd/1sd(2), 1120/180hp, 23.8kts, 8p; 1x1-20/65
	SP41	2	VMV19, 20	-	1943	No picture	22t, 21.9xm, 10kts
	RV4	2	RV4, 5	-	1951	No picture	12t, 9kts
	Koskelo	7	1-7	Koskelo, Kuikka, Kaakkuri, Kiisla, Kuovi, Telkkä, Kurki	1956-1959		97t, 29.0x5.0x1.5m, 2d, 1000hp, 16kts, 8p; 2x1-20/70; radar
	RV8	1	RV8	-	1958	No picture	10t, 10kts
	RV9	4	RV9-12	-	1959	No picture	12t, 10kts

[home](#)[World navies yesterday](#)[1960](#)

France 01 January 1960

SUBMARINES



Aurore	5	S601	L'Andromède	1953		970/1250t, 73.5x6.5x4.2m, 2d/em, 3000/1400hp, 15.5/9.3kts, 62p, 100m; 10-550TT; radar, sonar
		S603	L'Artémise	1954		
		S606	La Créole	1949		
		S607	L'Africaine	1949		
		S608	L'Astrée	1949		
VIIC	2	S609	Millé	1943		769/1070t, 67.1x6.2x4.7m, 2d/em, 3200hp, 17.7/7.6kts, 56p, 100m; 5-533TT; FuMO65 radar, sonar
		S610	Laubie	1943		
SS XXI	1	S613	Roland Morillot	1944		1621/1819t, 76.7x8.0x6.3m, 2d/em, 4000/4400hp, 15.6/17.2kts, 57p, 135m; 6-533TT; FuMO65 radar, sonar
Narval	4	S631	Narval	1957		1635/1910t, 78.4x7.8x5.2m, 2d/em, 4400/5000hp, 16/18kts, 63p, 200m; 8-550TT; Calypso radar, DUUA-1 sonar
		S632	Marsouin	1957		
		S633	Dauphin	1958		
		S634	Requin	1958		
Aréthuse	3	S635	Aréthuse	1959		543/669t, 49.6x5.8x4.0m, 2dg,1em, 1060/1300hp, 12.5/16kts, 39p, 180m; 4-550TT; Calypso radar, DUUA-1 sonar
		S636	Argonaute	1958		
		S639	Amazone	1959		

AIRCRAFT CARRIERS

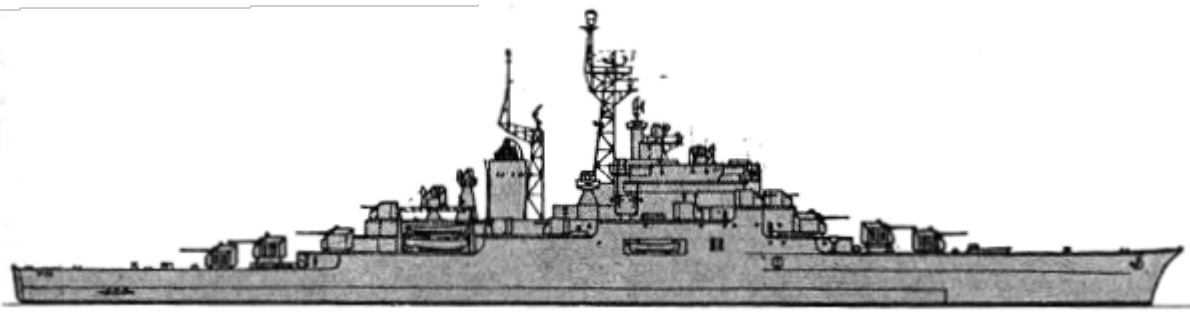
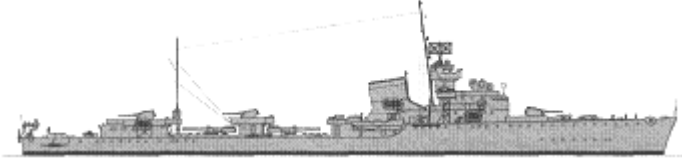
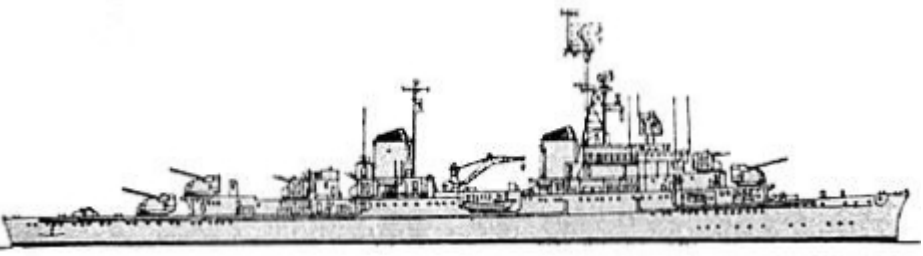
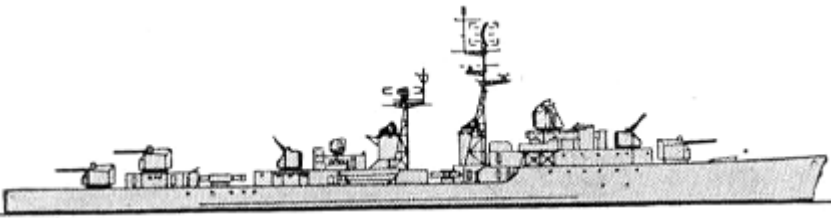
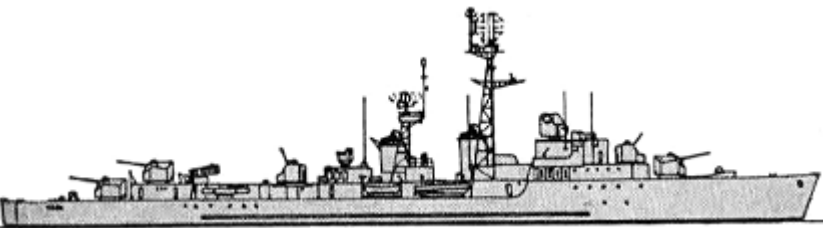
CVL	Colossus	1	R95	Arromanches	1944		17900t, 211.3x36.0x7.1m, 4b,2gst, 40000hp, 25kts, 1400p; 37aircraft (F4U Corsair, Aquilon fighters, Zéphyr attackers, TBM-3, Alizé ASW planes, HUP, Bell 47G, Alouette II, H-19, H-21, HSS helicopters); type 79B, 281B, DRBV-22A radars, type 144 sonar
			R96	La Fayette	1943		

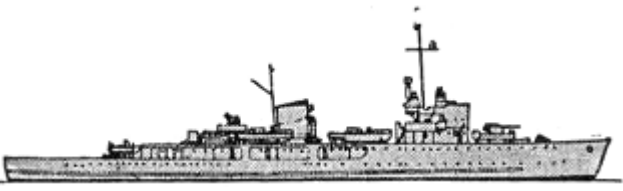
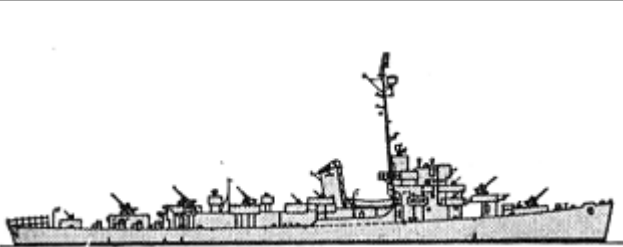
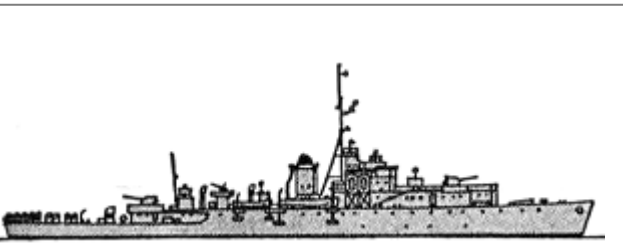
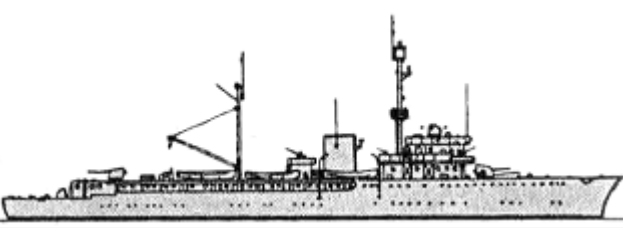
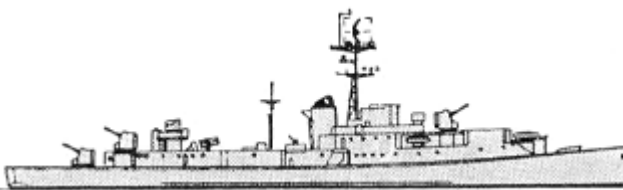
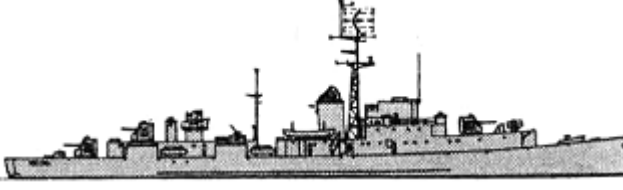

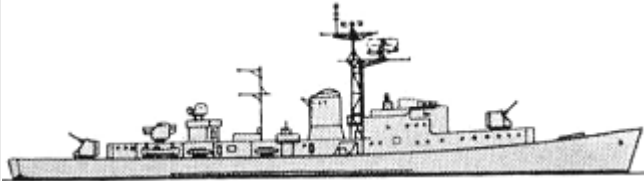
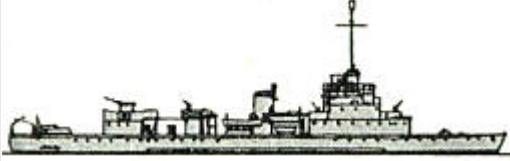



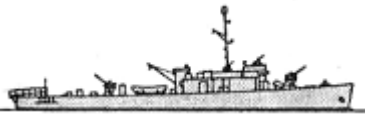

	Colbert	1	C611	Colbert	1959		977p; 80belt, 50deck; 8x2-127/54, 10x2-57/60, helodeck; DRBV-20A, DRBV-22A, DRBI-10, 4x DRBC-31B, 4x DRBC- 31A radars, DSBV-1 sonar, SENIT-1 CCS
	Soldati	1	T13	Duperré	1942		2460t, 106.7x10.2x3.5m, 3b,2gst, 48000hp, 38kts, 206p; 2x2-120/50, 3x1- 37/54, (4x2+5x1)-20/65, 1x3-533TT, 4dct; EC.3/ter radar, sonar
	Capitani Romani	2	D606	Châteaurenault	1942		5334t, 142.9x14.4x4.9m, 4b,2gst, 110000hp, 40kts, 418p; 20turrets, 15CT; 2x2-105/65, 5x2- 57/60, 2x3-550TT; DRBV-20A, DRBV-11, DRBC-11, 2x DRBC-30 radars
			D607	Guichen	1943		
DD	Surcouf	12	D621	Surcouf	1955		3740t, 128.6x12.7x5.4m, 4b,2gst, 63000hp, 34kts, 347p; 3x2-127/54, 3x2- 57/60, 4x1-20/70, 4x3- 550TT; DRBV-20A, DRBV-11, DRBC-11, 2x DRBC-30 radars, DUBV- 1, DUBA-1 sonars
			D622	Kersaint	1956		
			D623	Cassard	1956		
			D624	Bouvet	1956		
			D625	Dupetit-Thouars	1956		
			D626	Chevalier Paul	1956		
			D627	Maillé-Brézé	1957		
			D628	Vauquelin	1956		
			D629	D'Estrées	1957		
			D630	Du Chayla	1957		
			D631	Casabianca	1957		
			D632	Guépratte	1957		
	Duperré	5	D633	Duperré	1957		3740t, 128.6x12.7x5.4m, 4b,2gst, 63000hp, 34kts, 346p; 3x2-127/54, 3x2- 57/60, 4x1-20/70, 1x6- 375 Bofors Mk54 ASWRL, 2x3-550TT; DRBV-22A, DRBI-10, DRBC-11, 2x DRBC-30 radars, DUBV-1, DUBA- 1 sonars
			D634	La Bourdonnais	1958		
			D635	Forbin	1958		
			D636	Tartu	1958		
			D637	Jauréguiberry	1958		
				F750	La Pérouse	1943	

FF	Sans Souci	2	F751	Beautemps Beaupré	1942		178p; 1x1-105/45, 1x2-40/60(750), 2x2-40/60(751), 4x1-20/70, 2x24-178 Hedgehog AWSRL
	DET	7	F701	Algérien	1944		1602t, 93.3x11.2x3.2m, 4dg,2em, 6000hp, 21kts, 186p; 3x1-76/50, 3x1-40/60, 10x1-20/70, 1x24-178 Hedgehog ASWRL, 8dct, 2dcr; SPS-5, SPS-6 radars, sonar
			F702	Sénégalais	1943		
			F704	Hova	1944		
			F705	Marocain	1944		
			F706	Tunisien	1944		
			F723	Berbère	1944		
			F724	Malgache	1943		
	River	6	F707	L'Aventure	1944		2130t, 91.8x11.2x3.6m, 2b,2vte, 5500hp, 20kts, 140p; 2x1-105/45, (2x2+7x1)-20/70, 1x24-178 Hedgehog ASWRL, 8dct, 2dcr; type 272, 291 radars, sonar
			F708	La Surprise	1944		
			F709	L'Ailette	1944		
F710			Croix de Lorraine	1943			
F711			La Confiance	1943			
F712			La Découverte	1943			
Eritrea	1	F730	Francis Garnier	1937		3068t, 96.9x13.3x3.5m, 2d/2dg,2em, 9100hp, 20kts, 234p; 2x2-120/45, 2x2-37/54, 2x2-20/65	
Le Corse	4	F761	Le Corse	1955		1702t, 99.7x10.3x4.3m, 2b,2gst, 20000hp, 28kts, 174p; 3x2-57/60, 2x1-20/70, 4x3-550TT, 1x6-375 Bofors Mk54 ASWRL, 2dct, 1dcr; DRBV-20A, DRBC-30 radars, DUBV-1, DUBA-1 sonars	
		F762	Le Brestois	1956			
		F763	Le Boulonnais	1955			
		F764	Le Bordelais	1955			
Le Normand	11	F765	Le Normand	1956		1702t, 99.7x10.3x4.3m, 2b,2gst, 20000hp, 28kts, 175p; 3x2-57/60, 2x1-20/70, 4x3-550TT, 1x6-375 Bofors Mk54 ASWRL, 2dct, 1dcr; DRBV-22A, DRBV-31, DRBC-31 radars, DUBV-1, DUBA-1 sonars	
		F766	Le Picard	1956			
		F767	Le Gascon	1957			
		F768	Le Lorrain	1957			
		F769	Le Bourguignon	1957			
		F770	Le Champenois	1957			
		F771	Le Savoyard	1957			
		F772	Le Breton	1957			



			F773	Le Basque	1957		
			F774	L'Agenais	1958		
			F775	Le Béarnais	1958		
	L'Alsacien	1	F777	Le Provençal	1959		1702t, 99.7x10.3x4.3m, 2b,2gst, 20000hp, 28kts, 175p; 2x2-57/60, 2x1-20/70, 4x3-550TT, 1x4-305 ASWRL, 2dct, 1dcr; DRBV-22A, DRBV-31, DRBC-31 radars, DUBV-24, DUBA-1 sonars
FS	Élan	5	F741	Commandant Delage	1939		895t, 78.3x8.7x3.3m, 2d, 4000hp, 20kts, 106p; 1x1-105/45(742), 1x2-102/45(743,747), 1x2-90/50(741,745), 1x1-76/40(747), 1x1-40/60(742), 1x1-40/39(743,747), 1x1-25/60(743), 4x1-20/70(742), 2x1-20/70(743), (1x4+2x2)-13.2(741,745), 3x2-13.2(747), 4x2-13.2(743), (4x2+2x1)-12.7(742), 2dct, 1dcr
			F742	Commandant Dominié	1940		
			F743	Commandant Duboc	1939		
			F745	La Capricieuse	1940		
			F747	La Moqueuse	1940		
Chamois	5	F734	Chamois	1940		900t, 78.3x8.7x3.3m, 2d, 4000hp, 20kts, 106p; 2x1-105/45(737-739), 1x2-90/50(734,736), 1x1-40/60, 4x1-20/70(737-739), 6x1-20/70(734,736), 4dct, 2dcr	
		F736	Gazelle	1939			
		F737	Bisson	1947			
		F738	Commandant Amyot d'Inville	1947			
		F739	Commandant de Pimodan	1947			
Amiral Mouchez	1	P752	Amiral Mouchez	1937		970t, 62.0x10.3x3.4m, 1d, 800hp, 12kts, 81p; 2x1-100/45, 4x1-20/70, 2x1-13.2, 4dct, 2dcr; radar, sonar	

PATROL AND COASTAL COMBATANTS

PC	10	P603	Goumier	1942		430t, 52.9x7.1x2.4m, 2d, 2880hp, 20kts, 65p; 1x1-76/50, 1x1-40/60, 5x1-20/70, 2x4-178 Mousetrap ASWRL, 2dct, 2dcr; SU radar, sonar
		P604	Coutelas	1944		
		P606	Dague	1944		
		P608	Cimeterre	1944		
		P612	Voltigeur	1942		
		P615	Le Volontaire	1942		

PC							
		P616	Lancier	1943			
		P618	Fantassin	1942			
		P622	L'Indiscret	1942			
	Le Fougueux	3	P624	Hussard	1943		400t, 53.1x7.3x3.1m, 4d(2), 3240hp, 19kts, 62p; 2x1-40/60, 2x1-20/70, 1x24-178 Hedgehog ASWRL, 4dct, 2dcr; Decca radar, DUBA-2 sonar
			P641	Le Fougueux	1955		
			P642	L'Opniâtre	1955		
	L'Adroit	11	P643	L'Agile	1955		400t, 53.1x7.3x3.1m, 4d(2), 3240hp, 19kts, 62p; 2x1-40/60, 1x1-550TT(630), 1x1-120 ASWRL, 2dct, 2dcr; Decca radar, QCU-2 sonar
			P630	L'Intrépide	1959		
			P635	L'Ardent	1959		
			P637	L'Etourdi	1959		
			P638	L'Effronté	1959		
			P639	Le Frondeur	1959		
			P640	Le Fringant	1959		
			P644	L'Adroit	1958		
			P645	L'Alerte	1958		
			P646	L'Attentif	1958		
			P647	L'Enjoué	1958		
	L'Ajacienne	2	P648	Le Hardi	1959		466t, 48.8x8.1x3.7m, 1b,1vte, 800hp, 10kts, 20p; 1x1-102/40, 4x1-13.2
P138			La Toulonnaise	1934			
YMS	2	P139	La Sétoise	1934		320t, 41.5x7.5x2.4m, 2d, 800hp, 14kts, 60p; 1x1-76/50, 2x1-20/70, 2dct, 2dcr; SO radar	
		P656	Tiaré	1942			
SC	SC	8	P658	Lotus	1942		138t, 33.8x5.2x1.9m, 2d, 2400-1000hp, 21-16kts, 27p; 1x1-40/60, 3x1-20/70, 2x4-178 Mousetrap ASWRL, 2dct, 2dcr; SCR-517A radar, QC sonar
			P690	Ch690	1942		
			P691	Ch691	1942		
			P693	Ch693	1942		
			P699	Ch699	1943		
			P700	Ch700	1943		
			P711	Ch711	1942		
			P713	Ch713	1942		
YP	HDML	21	P714	Ch714	1942		54t, 22.0x4.8x1.4m, 2d, 260-300hp, 11-11.8kts, 10p; 2x1-20/70, 8dc
			P747, 749-763, 765-768, 771	VP747, 749-763, 765-768, 771	1941 - 1945		
	VC1	12	P751-762	VC1-12	1956 - 1959		80t, 31.8x4.7x1.7m, 2d, 2700hp, 28kts, 15kts; 2x1-20/70

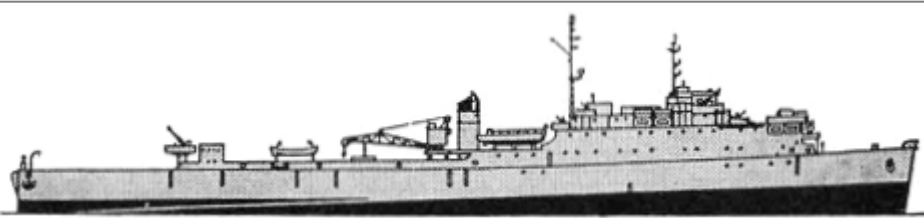
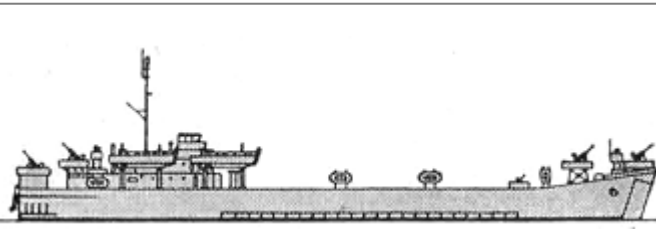
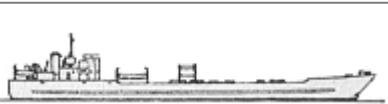
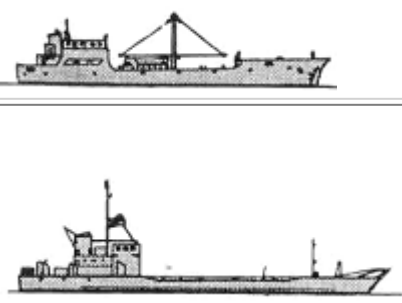
AMPHIBIOUS

LSD	BAPM	1	L9020	Foudre	1944		7930t, 139.5x22.0x4.8m, 2b,2quipe, 7400hp, 15kts, 212p; 1x1-105/45, 2x1-120/12, 2x2-40/60, 4x1-20/70; 3 LCT(5), 263troops; radar	
LST	LST(2)	6	L9001	Laïta	1943		4080t, 100.0x15.2x4.3m, 2d, 1800hp, 11kts, 111p; (2x2+4x1)-40/60, 12x1-20/70; 4 LCVP, 20tanks, 163troops; radar	
			L9002	Orne	1944			
			L9004	Rance	1943			
			L9005	Odet	1944			
			L9006	Chélif	1944			
			L9008	Golo	1945			
LCU	LCT(4)	3	L9062	LCT9062	1941/45		640t, 57.1x11.8x1.4m, 2d, 920hp, 10kts, 12p; 2x1-20/70; 6tanks	
			L9065	LCT9065	1941/45			
			L9099	LCT9099	1941/45			
	EDIC	6	1	L9097	Issole	1958		610t, 48.7x7.0x2.1m, 2d, 1000hp, 12kts, 20p; 190t cargo; DRBN-31 radar
				L9091	EDIC9091	1958		
				L9092	EDIC9092	1959		
				L9093	EDIC9093	1959		
				L9094	EDIC9094	1959		
				L9095	EDIC9095	1959		
L9096	EDIC9096	1959						
LC	LCM(6)	31	1-31	LCM1031-1036, 1041-1046, 1051-1056, 1071-1076, 1081-1087	1943 - 1945		56t, 17.1x4.3x1.2m, 2d, 450hp, 9kts, 5p; 2x1-12.7; 1tank	

MINE WARFARE SHIPS

MSO	Aggressive	15	M609	Narvik	1956		735t, 52.3x10.4x4.0m, 2d, 1520hp, 13kts, 70p; 1x1-40/60, 2x1-12.7, mechanical, acoustic, magnetic sweeping gear; SPS-53 radar, UQS-1 sonar
			M610	Ouireham	1956		
			M612	Alençon	1954		
			M613	Berneval	1954		
			M614	Bir Hacheim	1954		
			M615	Cantho	1955		
			M616	Dompaire	1954		
			M617	Garigliano	1954		
			M618	Mytho	1954		
			M619	Vinh Long	1955		
			M620	Berlaimont	1956		
			M621	Origny	1956		

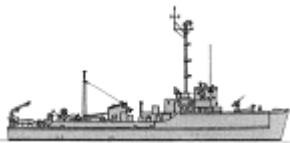
		M622	Autun	1956		
		M623	Baccarat	1956		
		M624	Colmar	1956		
	YMS	17	M641	Amarante	1943	 <p>320t, 41.5x7.5x2.4m, 2d, 800hp, 14kts, 60p; 1x1-76/50, 2x1-20/70, 2dct, 2dcr, mechanical, magnetic, acoustic sweeping gear; SO radar</p>
			M643	Asphodèle	1943	
			M644	Basilic	1942	
			M646	Tiare	1943	
			M648	Gentiane	1942	
			M649	Pimpernelle	1942	
			M650	Primevère	1942	
			M651	Genêt	1943	
			M652	Lotus	1943	
			M653	Balsamine	1942	
			M659	Hortensia	1942	
			M660	Jonquille	1942	
			M661	Campanule	1942	
			M662	Héliotrope	1942	
			M663	Jasmin	1942	
			M664	Perce-Neige	1942	
			M665	Anémone	1942	
	Bluebird	32	M631	Pavot	1955	 <p>400t, 44.3x8.1x2.1m, 2d, 1200hp, 13kts, 39p; 1x2-20/70, mechanical, acoustic and magnetic sweeping gears; SPS-53 radar, UQS-1 sonar</p>
			M632	Pervenche	1954	
			M633	Pivoine	1955	
			M634	Renoncule	1955	
			M635	Réséda	1955	
			M638	Acacia	1953	
			M639	Acanthe	1953	
			M640	Aconit	1953	
			M667	Ajonc	1954	
			M668	Azalée	1953	
			M669	Bégonia	1954	
			M670	Bleuet	1954	
			M671	Camélia	1954	
			M672	Chrysanthème	1954	
	M673	Coquelicot	1954			
	M674	Cyclamen	1954			
	M675	Églantine	1954			
	M676	Gardenia	1954			
	M677	Giroflée	1954			
	M678	Glaïeul	1954			
	M679	Glycine	1954			

MSC

M680	Jacinthe	1954
M681	Laurier	1954
M682	Lilas	1954
M683	Liseron	1955
M684	Lobélia	1955
M685	Magnolia	1954
M686	Marguerite	1954
M687	Mimosa	1955
M688	Miguet	1955



Ton

34

M701	Sirius	1954
M702	Rigel	1954
M703	Antarès	1954
M704	Algol	1954
M705	Aldébaran	1955
M706	Régulus	1954
M707	Véga	1954
M708	Castor	1955
M709	Pollux	1955
M710	Pégase	1956
M734	Croix du Sud	1956
M735	Étoile Polaire	1958
M736	Altaïr	1958
M737	Capricorne	1958
M740	Cassiopee	1954
M741	Eridan	1955
M742	Orion	1955
M743	Sagittaire	1955
M744	Achernar	1955
M745	Procyon	1955
M746	Arcturus	1954
M747	Bételgeuse	1954
M748	Persée	1956
M749	Phénix	1956
M750	Bellatrix	1956
M751	Dénébola	1956
M752	Centaure	1956
M753	Fomalhaut	1956
M754	Canopus	1956
M755	Capella	1956
M739	Céphée	1956



424t, 46.4x8.6x2.5m, 2gg,2gt or 2d, 2000hp, 15kts, 38p; 1x1-40/60, 1x1-20/70, mechanical, acoustic, magnetic sweeping gear; radar

			M757	Verseau	1956		
			M758	Ariès	1956		
			M759	Lyre	1957		
	Bay	6	M726	La Dunkerquoise	1954		412t, 46.3x8.5x2.6m, 2d, 2400hp, 15kts, 40p; 1x1-40/60, mechanical, acoustic, magnetic sweeping gear; radar
			M727	La Malouine	1953		
			M728	La Bayonnaise	1953		
			M729	La Paimpolaise	1953		
			M730	La Dieppoise	1954		
			M731	La Lorientaise	1954		
	Mercure	1	M765	Mercure	1958		400t, 44.4x8.3x4.0m, 2d, 4000hp, 15kts, 48p; 1x2-20/70, mechanical, acoustic, magnetic sweeping gear; radar
MSI	Ham	15	M771	Tulipe	1954		159t, 32.5x6.6x1.8m, 2d, 1100hp, 14kts, 15p; 1x1-40/60, mechanical sweeping gear; type 978 radar
			M772	Armoise	1955		
			M773	Violette	1955		
			M774	Œillet	1955		
			M775	Pâquerette	1955		
			M776	Jasmin	1955		
			M781	Aubépine	1955		
			M782	Capucine	1955		
			M783	Hortensia	1955		
			M784	Géranium	1955		
			M785	Hibiscus	1955		
			M786	Dahlia	1955		
			M787	Jonquille	1955		
M788	Myosotis	1955					
M789	Pétunia	1955					



[home](#)[World navies yesterday](#)[1960](#)





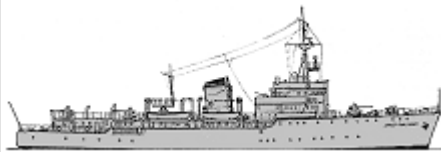

East Germany 01 January 1960

PRINCIPAL SURFACE COMBATANTS





FF	pr. 50	4	101	50/1	1955		1337t, 90.9x10.2x2.9m, 2b,2gst, 20000hp, 29kts, 168p; 3x1-100/56, 2x2-37/70, 1x2-533TT(101,102), 1x3-533TT(103,104), 2x24 MBU-200 ASWRL(101,102), 2x16 RBU-2500 ASWRL(103,104), 4dct, 2dcr; Giuys-1M4(101,102), Fut-N(103,104), Lin'(101,102), Neptun-M(103,104), Don, Yakor'(101,102), Yakor'-M(103,104) radars, Pegas-2M(101,102), Pegas-3M(103,104) sonar, Bizan'-4 ECM
			102	50/2	1955		
			103	50/3	1954		
			104	50/4	1954		



PATROL AND COASTAL COMBATANTS

PS	Hvidbjörnen	1	1	Ernst Thälmann	1929		1100t, 65.6x9.8x5.4m, 2b,1vte, 1200hp, 13.2kts, 56+56cadets; 1x1-85/52, 2x1-37/63, 1x2-25/80; radar
PC	pr. 201M	10	454	201/1	1959		216t, 41.7x6.2x1.9m, 3d, 6600hp, 27kts, 27p; 2x2-25/80, 4x5 RBU-1200 ASWRL, 2dcr, 18mines; Reya radar, Tamir-11 sonar
			413	201/2	1959		
			434	201/3	1959		
			414	201/4	1959		
			451	201/5	1959		
			452	201/6	1959		
			453	201/7	1959		
			431	201/8	1959		
			432	201/9	1959		
			433	201/10	1959		
PT	pr. 183	14	803	183/1	1957		67t, 25.5x6.2x1.2m, 4d, 6000hp, 43kts, 14p; 2x2-25/80, 2-533TT, 2dcr; Zarnitsa radar
			802	183/2	1957		
			805	183/3	1957		
			806	183/4	1957		
			808	183/5	1957		
			809	183/6	1957		
			807	183/7	1957		
			801	183/8	1957		
			804	183/9	1957		

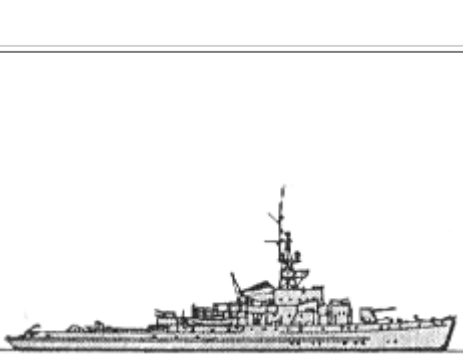
			822	183/10	1958		
			823	183/11	1958		
			825	183/12	1958		
			826	183/13	1958		
			828	183/14	1958		
	Hydra	1	68.1		1959		15t, 13.0x3.6x0.9m, 1d, 1200hp, 35kts, 3p; 3-533TT; KSA-3 radar
PB	1/50	6	1/50-6/50		1950-1951		72t, 26.8x4.6x1.4m, 3d, 1600hp, 20kts, 20p; 2x1-20/70
	No13	12	13, 14, 17-20, 27-32		1951-1953		78t, 28.8x4.8x1.5m, 3d, 1600hp, 24kts, 20p; 2x2-14.5, 2dcr; Tamir-10 sonar
	Delphin	12	1-12	Delphin 1-12	1953-1954		38t, 22.4x4.1x1.3m, 2d, 600hp, 21kts, 7p; 1x1-12.7
	Tümmeler 1	6	1-6	Tümmeler 1-6	1954		38t, 22.6x4.1x1.3m, 2d, 600hp, 19kts, 9p; 2x2-12.7
	Tümmeler 7	6	7-12	Tümmeler 7-12	1956		38t, 22.6x4.1x1.3m, 2d, 250hp, 11kts, 9p; 2x2-12.7

MINE WARFARE

MSO	Habicht 1	4	213	6/31	1953		510t, 59.1x8.0x2.3m, 2d, 2400hp, 18kts, 38p; 1x1-37/63, 4x1-25/80, mechanical, acoustic, magnetic minesweeping gear, 18mines; Tamir-11 sonar
			214	6/32	1953		
			251	6/34	1953		
			212	6/36	1954		
	Habicht 2	6	1	6/11	1955		670t, 65.1x8.1x2.3m, 2d, 2400hp, 17kts, 38p; 1x1-85/52, 4x2-25/80, 2dcr, 20mines, mechanical, magnetic, acoustic minesweeping gear; Zarnitsa radar, Tamir-11 sonar
			2	6/12	1955		
			3	6/13	1955		
			4	6/14	1955		
			5	6/15	1955		
			6	6/16	1955		
Krake	10	227	3001	1957		741t, 66.1x8.4x2.5m, 2d, 2400hp, 16.5kts, 38p; 1x1-85/52, 5x2-25/80, 2dcr, 30mines, mechanical, magnetic, acoustic minesweeping gear; KSIB radar, Tamir-11 sonar	
		220	3002	1957			
		221	3003	1957			
		223	3004	1957			
		224	3005	1957			
		229	3006	1958			
		228	3007	1958			
		225	3008	1958			
		222	3009	1958			
		226	3010	1958			
	Schwalbe 1	2	411, 414		1953		84t, 28.8x4.4x1.3m, 2d, 300hp, 11.3kts, 14p; 1x2-12.7, mechanical, magnetic, acoustic minesweeping gear

MSI	Schwalbe 2	24	421-426, 431-436, 441-446, 451-456	1955-1956		84t, 28.8x4.4x1.3m, 2d, 300hp, 11.3kts, 14p; 1x2-12.7, mechanical, magnetic, acoustic minesweeping gear
	Schwalbe 3	18	321-326, 341-346, 361-366	1956-1958		84t, 28.8x4.4x1.3m, 2d, 530hp, 11.3kts, 14p; 1x2-25/80, mechanical, magnetic, acoustic minesweeping gear

BOARD GUARD

PB	No13	8	G111, 112, 121, 122, 131, 132, 141, 142	1951-1952		78t, 28.8x4.8x1.5m, 2d, 550hp, 12kts, 20p; 2x2-14.5, 2dcr; Zarnitsa radar, Tamir-10 sonar
----	------	---	---	-----------	---	---

© Ivan Gogin, 2016

[home](#)[World navies yesterday](#)[1960](#)

West Germany 01 January 1960

SUBMARINES

SS	Type XXIII	2	S170	Hai	1945		234/275t, 36.1x3.0x3.7m, 1dg,1em, 630/580hp, 9.7/12.5kts, 17p, 80m; 2-533TT
			S171	Hecht	1945		

PRINCIPAL SURFACE COMBATANTS

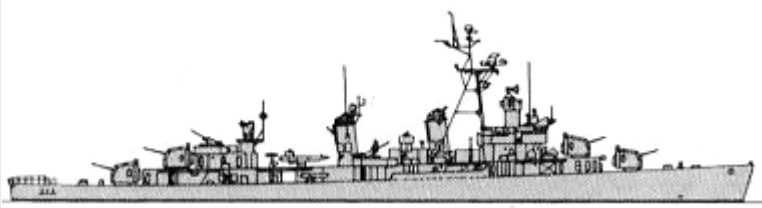
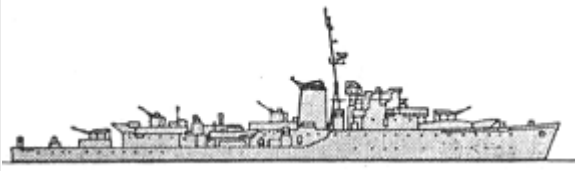
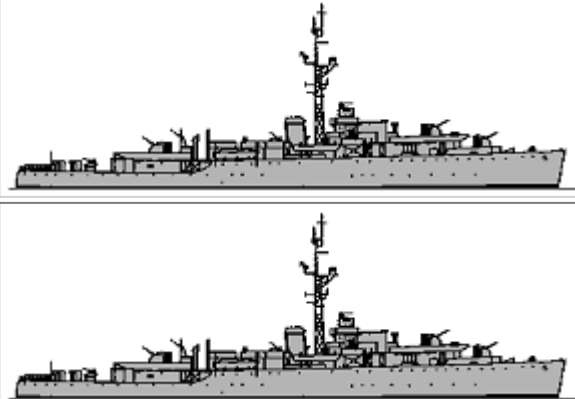
DD	Fletcher	4	D170	Zerstörer 1	1943		3120t, 114.7x12.1x5.5m, 4b,2gst, 60000hp, 32kts, 244p; 4x1-127/38, 3x2-76/50, (1x5+2)-533TT, 2x24-178 Hedgehog ASWRL, 1dcr, mines; SPS-6, SPS-10, SPG-25, SPG-36, SPG-35 radars, SQS-29 sonar
			D171	Zerstörer 2	1942		
			D172	Zerstörer 3	1943		
			D178	Zerstörer 4	1942		
FF	Hunt batch 2	1	F212	Gneisenau	1942		1610t, 86.1x9.6x3.8m, 2b,2gst, 19000hp, 27kts, 168p; 2x2-102/45, 2x1-40/60, 2dct, 3dcr; type 271, 285, 290 radars, type 123A, 127 sonars
			mod. Black Swan	3	F213		
	F214	Hipper			1946		
	F216	Scheer			1943		
	Black Swan	1	F215	Graf Spee	1939		1945t, 91.3x11.4x3.5m, 2b,2gst, 4300hp, 19.7kts, 180p; 3x2-102/45, 1x4-40/39, (2x2+2x1)-20/70, 1x24-178 Hedgehog ASWRL, 4dct, 2dcr; type 285 radar, type 123A, 177 sonars
	F218	Brommy	1943				
	Type			F207	Biene	1941	
F208				Bremse	1941		

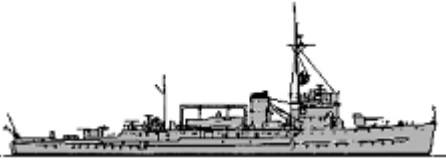
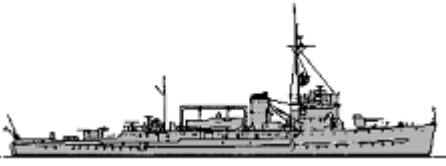

FS	1939(Mob)	4	F209	Brummer	1942		878t, 68.3x8.7x2.6m, 2b,2se, 3500hp, 18.3kts, 100p; 1x1-105/45, 1x24-178 Hedgehog ASWRL
			F210	Hummel	1941		
	Type 1935	1	F211	Wespe	1941		874t, 68.1x8.7x2.6m, 2b,2se, 3500hp, 18.3kts, 100p; 1x1-105/45, 1x24-178 Hedgehog ASWRL

PATROL AND COASTAL COMBATANTS



PT	Silbermöwe	6	P6052	Silbermöwe	1956		155t, 35.6x5.2x1.6m, 3d, 9000hp, 42kts, 19p; 1x1-40/70, 2-533TT; radar
			P6053	Sturmmöwe	1956		
P6054			Wildschwan	1956			
P6055			Eismöwe	1955			
P6056			Raubmöwe	1956			
P6057			Seeschwalbe	1957			
Jaguar	22	P6058	Illtis	1957		210(6058-6067,6082,6083)-221(6068-6077)t, 42.6x7.1x2.3(6058-6067,6082,6083)-2.4(6068-6077)m, 4d, 14400hp, 43kts, 39p; 2x1-40/70, 4-533TT; Decca 1226 radar	
		P6059	Jaguar	1957			
		P6060	Leopard	1958			
		P6061	Luchs	1958			
		P6062	Wolf	1958			
		P6063	Tiger	1958			
		P6064	Panther	1958			
		P6065	Löwe	1959			
		P6066	Fuchs	1959			
		P6067	Marder	1959			
		P6068	Seeadler	1959			
		P6069	Albatros	1959			
		P6070	Kondor	1959			
		P6071	Greif	1959			
		P6072	Falke	1959			
		P6073	Geier	1959			
		P6074	Bussard	1959			
P6075	Habicht	1959					
P6076	Sperber	1959					
P6077	Kormoran	1959					
			P6082	Weihe	1959		
			P6083	Kranich	1959		
			Y827	KW15	1953		
			Y830	KW16	1953		

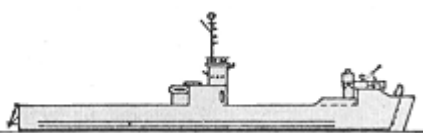

PB	P1	10	Y832	KW18	1953		78t, 29.0x4.7x1.4m, 2d, 2000hp, 25kts, 17p; 2x1-20/80; radar
			Y833	KW19	1953		
			Y845	KW17	1953		
			Y846	KW20	1953		
			Y857	KW11	1952		
			Y858	KW12	1952		
			Y859	KW13	1952		
			Y860	KW14	1952		

AMPHIBIOUS







LSM	LSM	4	L750	Krokodil	1945		1095t, 62.0x10.5x2.1m, 2d, 2800hp, 13kts, 60p; 1x2-40/60, helodeck(750); 5tanks, 54troops; radar
			L751	Eidechse	1945		
			L752	Salamander	1945		
			L753	Viper	1945		
LSS	LCT(6)	1	LCU1		1944		320t, 36.3x10.0x1.2m, 3d, 675hp, 8kts, 13p; 1x1-12.7; 4tanks
LFS	LSM(R)	2	L754	Otter	1945		1175t, 62.0x10.5x2.1m, 2d, 2800hp, 13kts, 143p; 1x1-127/38, 2x2-40/60, 4x2-20/70, 4x1-107/10mortars, 5x2-127RL; radar
			L755	Natter	1945		

MINE WARFARE

MSO	Type 1940	5	M187	Seehund	1944		775t, 62.3x8.9x2.7m, 2b,2vte, 2700hp, 17.2kts, 70p; 1x1-76/50, 2x2-40/60, 3x1-20/80, minesweeping gear
			M188	Seeigel	1943		
			M189	Seelöwe	1942		
			M190	Seepferd	1944		
			M192	Seestern	1944		
	Type 1943	1	M191	Seeschlange	1945		821t, 63.1x9.0x2.6m, 2b,2vte, 2700hp, 16.7kts, 70p; 1x1-76/50, 2x2-40/60, 3x1-20/80, minesweeping gear
	Lindau	15	M1070	Göttingen	1958		380t, 45.0(1070-1075)-45.6(1076-1084)x8.0x2.5m, 2d, 4000hp, 17kts, 45p; 1x1-40/70, 4dcr, mines, mechanical, acoustic, magnetic minesweeping gear; TRS-N radar, DSQS-11 sonar
M1071			Koblenz	1958			
M1072			Lindau	1958			
M1073			Schleswig	1958			
M1074			Tübingen	1958			
M1075			Wetzlar	1958			
M1076			Paderborn	1958			
M1077			Weilheim	1959			

MSC							
		M1078	Cuxhaven	1959			
		M1079	Düren	1959			
		M1080	Marburg	1959			
		M1081	Konstanz	1959			
		M1082	Wolfsburg	1959			
		M1083	Ulm	1959			
	M1084	Flensburg	1959				
Mercure 2	M1250	Veogesack	1959			383t, 44.6x8.4x2.6m, 2d, 1320hp, 14.5kts, 40p; 1x2-20/70, mechanical, acoustic, magnetic minesweeping gear; Decca 707 radar, Simrad sonar	
	M1251	Hameln	1959				
MSI	Schütze 2	M1052	Krebs	1959		267t, 47.4x6.9x2.3m, 2d, 4500(1052)-4760(1062)hp, 25kts, 31p; 1x1-40/70, mechanical, acoustic, magnetic minesweeping gear; TRS-N radar	
		M1062	Schütze	1959			

COAST GUARD

PC	La Fougueux	1	W51	UW12	1955		400t, 53.1x7.3x3.1m, 4d(2), 3240hp, 19kts, 62p; 2x1-40/60, 2x1-20/70, 1x24-178 Hedgehog ASWRL, 4dct, 2dcr; Decca radar, DUBA-2 sonar
PB	S38	1	UW10		1943		115t, 34.9x5.3x1.7m, 3d, 7500hp, 41kts, 24p; 1x1-20/80
	S139	1	UW11		1944		122t, 34.9x5.3x1.7m, 3d, 7500hp, 41kts, 24p; 1x1-20/80, 2-533TT
	KWK	10	W1	H1	1944		112t, 22.3x6.4x2.7m, 1d, 150hp, 11kts, 16p; 1x1-20/80
			W2	H2	1944		
			W3	H3	1944		
			W4	H4	1944		
			W5	H5	1944		
			W6	H6	1944		
			W7	H7	1944		
			W8	H8	1944		
			W9	H9	1944		
W10			H10	1944			
W21	1	W21	Niobe	1958		171t, 35.2x6.8x1.7m, 2d, 2000hp, 16kts, 20p; 1x1-40/70, mechanical, acoustic, magnetic minesweeping gear; TRS-N radar	
W22	1	W22	Hansa	1958		175t, 35.2x6.6x1.9m, 1d, 1000hp, 14kts, 20p; 1x1-40/70, mechanical, acoustic, magnetic minesweeping gear; TRS-N radar	

[home](#)

[World navies yesterday](#)

[1960](#)

Ghana 01 January 1960

MINE WARFARE

MSI	Ham	2	M11	Yogaga	1958		159t, 32.8(11)-32.5(12)x6.7(11)-6.6(12)x1.7m, 2d, 1100hp, 14kts, 15p; 1x1-20/70, minesweeping gear; type 978 radar
			M12	Afadzato	1958		

© Ivan Gogin, 2016

[home](#)[World navies yesterday](#)[1960](#)

Greece 01 January 1960

SUBMARINES

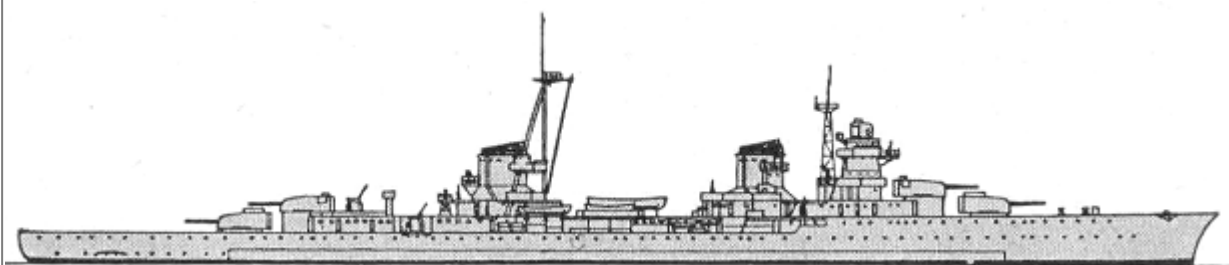
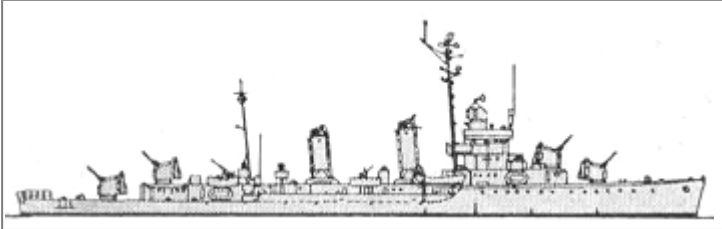
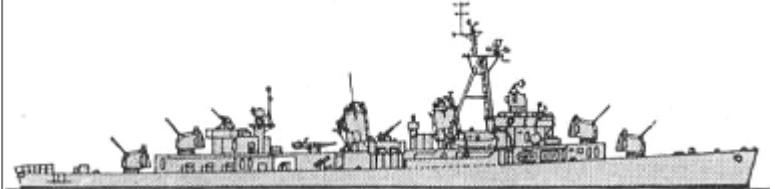
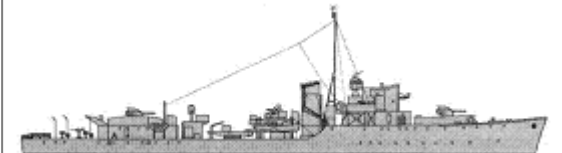

SS	Gato	2	S78	Poseidon	1943		1845/2415t, 95.0x8.3x4.7m, 4dg,4em(2), 5400/2740hp, 20.2/8.7kts, 60p, 90m; 1x1-127/25, 10-533TT; SS, ST, SV radars, sonars
			S117	Amfitriti	1943		

PRINCIPAL SURFACE COMBATANTS

CL	Eugenio di Savoia	1	C24	Elli	1936		10672t, 186.9x17.5x6.5m, 6b,2gst, 110000hp, 36.5kts, 694p; 105belt, 35deck, 90turrets, 100CT; 4x2-152/53, 3x2-100/47, 4x2-37/54, 12x1-20/70, 2x3-533TT, 2dct, 146mines; EC.3/ter radar
DD	Gleaves	2	D16	Doxa	1941		2572t, 106.2x11.0x4.0m, 4b,2gst, 50000hp, 35kts, 208p; 4x1-127/38, (2x4+2x2)-40/60, 2x2-20/70, 6dct, 2dcr; SC, Mk12/22 radars, sonar
			D63	Niki	1940		
DD	Fletcher	3	D06	Aspis	1943		3005t, 114.7x12.1x4.2m, 4b,2gst, 60000hp, 38kts, 250p; 4x1-127/38, 3x2-76/50, 1x5-533TT, 2x3-324TT, 2x24-178 Hedgehog AWSRL, 6dct, 2dcr; SPS-6, SPS-10, Mk25, Mk35, SPG-53 radars, SQS-39/43 sonar
			D16	Velos	1943		
			D85	Sfendoni	1942		
FF	Hunt 2	3	D14	Astings	1942		1590t, 85.3x9.6x3.7m, 2b,2gst, 19000hp, 27kts, 168p; 2x2-102/45, 1x4-40/39, 3x1-20/70, 1x2-533TT, 4dct, 2dcr; type 272, 285, 291 radars, type 123A, 127 sonars
			D59	Miaoulis	1942		
			D06	Adrias	1942		
FF	Cannon	4	D01	Aetos	1944		1900t, 93.3x11.2x3.2m, 4dg,2em, 6000hp, 21kts, 220p; 3x1-76/50, 3x2-40/60, 7x2-20/70, 2x3-324TT, 1x24-178 Hedgehog
			D31	Ierax	1944		
			D54	Leon	1943		

LSD	Ashville	1	L153	Nafkratousa	1943		9375t, 139.5x22.0x4.8m, 2b,2quipe, 7000hp, 15.4kts, 254p; 1x1-76/40, 2x2-40/60; 3 LCT(6), 332troops; SPS-6 radar	
LST(2)	3	L158	Limnos	1943			4080t, 100.0x15.2x4.3m, 2d, 1800hp, 12.1kts, 125p; 1x1-76/50, 6x1-20/70; 4 LCVP, 20tanks, 153troops; radar	
		L179	Samos	1943				
		L195	Chios	1943				
LST	LST(3)	6	L104	Aliakmon	1945			4980t, 105.9x16.8x3.8m, 2b,2vte, 5500hp, 13.5kts, 111p; 2x2-40/60, (2x2+2x1)-20/70; 5 LCA, 1 LCT(6), 15tanks, 170troops; radar
			L109	Axios	1945			
			L107	Alfeios	1945			
			L182	Strymon	1945			
			L116	Achelaos	1945			
			L171	Pyneos	1945			
LSM	LSM1	6	L161	Ipopliarchos Grigoropoulos	1944			1095t, 62.0x10.5x2.1m, 2d, 2800hp, 13.2kts, 60p; 1x2-40/60, 4x1-20/70; 5tanks, 54troops; radar
			L162	Ipopliarchos Tournas	1944			
			L163	Ipopliarchos Daniolos	1944			
			L164	Ipopliarchos Roussen	1945			
			L165	Ipopliarchos Krystallidis	1945			
			L166	Ipopliarchos Merlin	1945			
LCU	LCT(4)	8	L183	Kandanos	1943			640t, 57.1x11.8x1.4m, 2d, 920hp, 10kts, 12p; 2x1-20/70; 6tanks
			L184	Sofades	1943			
			L185	Kithera	1944			
			L186	Serifos	1944			
			L187	Anafi	1944			
			L188	Thira	1944			
			L189	Milos	1944			
			L190	Amorgas	1944			
	LCT(6)	2	L151	Skopelos	1944			320t, 36.3x10.0x1.2m, 3d, 675hp, 8kts, 13p; 2x1-20/70; 4tanks
			L152	Skiathos	1944			
LC	LCA	7	1-7	AB EF1725, 1726, 1746, 1775, 1818, 1854, 1886	1940-1944	No picture		12t, 12.6x3.1x0.7m, 2pe, 130p, 8kts, 4p; 2x1-51/11 mortars; 40troops
	LCVP	14	1-14		1943-1945			13t, 10.9x3.2x1.0m, 1d, 225hp, 9kts, 3p; 2x1-12.7; 36troops
	LCM(6)	11	1-11		1944-1945			56t, 17.1x4.3x1.2m, 2d, 330hp, 10kts, 5p; 2x1-12.7; 1tank

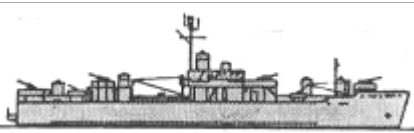
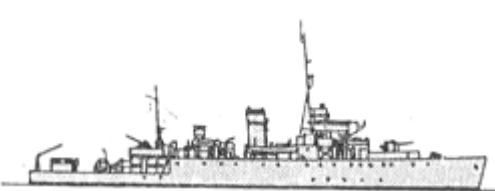
MINE WARFARE

ML	LSM	2	N04	Aktion	1945		1100t, 62.1x10.5x2.6m, 2d, 2880hp, 12kts, 65p; 4x2-40/60, 6x1-20/70, 300mines; Decca 1226C radar
			N05	Amvrakia	1945		
MSO	Algerine	5	M64	Navmachos	1943		1325t, 68.6x10.8x3.3m, 2b,2vte, 2400hp, 16.5kts, 138p; 1x1-102/45, 4x2-20/70, 4dct, 2dcr, sweeps; radar, sonar
			M74	Polemistis	1943		
			M76	Pyrpolitis	1943		
			M12	Armatolos	1943		
			M58	Machitis	1943		
MSC	YMS	15	M201	Kalymnos	1943		320t, 41.5x7.5x2.4m, 2d, 800hp, 14kts, 60p; 1x1-76/50, 2x1-20/70, 2dct, 2dcr, sweeps; radar
				Aura	1943		
			M202	Paxoi	1943		
			M203	Karteria	1943		
			M204	Paralos	1943		
			M205	Salaminia	1943		
			M206	Lefkas	1943		
			M207	Kefallinia	1943		
			M208	Kerkyra	1943		
			M209	Afroessa	1943		
			M210	Leros	1943		
			M211	Symi	1943		
			M212	Zakynthos	1943		
			M213	Patmos	1943		
M214	Ithaki	1943					
MSI	APc	6	FT-11	Velestinon	1942	No picture	229t, 31.4x6.5x2.5m, 1d, 500hp, 10kts, 25p; 2x1-20/70, sweeps
			FT-12	Elasson	1942		
			FT-13	Kalavrita	1942		
			FT-15	Distomon	1942		
			FT-24	Lechovon	1942		
			FT-28	Anchialos	1942		

[home](#)

[World navies yesterday](#)

[1960](#)

Guatemala 01 January 1960

PATROL AND COASTAL COMBATANTS

PC	Jägaren	1	1	José Francisco Barrundia	1936		310t, 51.9x6.0x2.8m, 2b,1gst, 3600hp, 23kts, 41p; 2x1-75/60, 2x1-25/58, 2dct
----	---------	---	---	--------------------------	------	--	--

© Ivan Gogin, 2016

[home](#)[World navies yesterday](#)[1960](#)

Haiti 01 January 1960

COAST GUARD

PC	PC453	1	GC2	16 Août 1946	1941	No picture	100t, 33.5x5.5x1.8m, 2d, 1540hp, 17kts, 27p; 1x1-40/60, 2x1-20/70, 2dcr
	SC 110ft	1	GC3	Toussaint L'Overture	1943		136t, 33.8x5.5x2.0m, 2d, 2400hp, 21kts, 27p; 1x1-40/60, 3x1-20/70, 2x4-178 Mousetrap ASWRL, 2dct, 2dcr; radar, QC sonar
	Cape	1	GC8	La Crête-à-Pierrot	1955		106t, 29.0x5.8x1.8m, 4d(2), 2200hp, 20kts, 15p; 3x1-20/70; radar
PB	USCG 83ft	6	Nr.1-6		1942		45t, 25.3x4.9x1.4m, 1200hp, 20.5kts, 10p; 1x1-20/70, 2x4-178 Mousetrap ASWRL, 4dcr; radar, sonar
	USCG	1	GC1	Savannah	1944	No picture	47t, 25.3x4.9x1.3m, 2d, 200hp, 9kts, 12p

© Ivan Gogin, 2016

[home](#)[World navies yesterday](#)[1960](#)

Hong Kong 01 January 1960

POLICE FORCE

PB	Snipe	8	PL9	Snipe	1946	No picture	28t, 13.7x4.6x2.1m, 1d, 144hp, 9kts, 5p
			PL10	Puffin	1946		
			PL11	Wren	1946		
			PL12	Mallard	1946		
			PL13	Gull	1946		
			PL14	Tern	1946		
			PL15	Cormorant	1946		
			PL16	Kestrel	1946		
	Sea Rover	9	PL26	Sea Rover	1954	No picture	52t, 21.3x5.2x1.6m, 2d, 288hp, 10kts, 12p; 1x1-12.7; radar
			PL27	Sea Farer	1954		
			PL28	Sea Roamer	1954		
			PL29	Sea Rider	1955		
			PL30	Sea Nomad	1955		
			PL31	Sea Wanderer	1955		
			PL32	Sea Raker	1955		
			PL33	Sea Rescuer	1955		
Sea Horse	1	PL4	Sea Horse	1958	No picture	72t, 23.8x4.6x1.4m, 3d, 705hp, 15kts, 21p; 1x1-12.7; radar	
Islander	1	PL6	Islander	1958	No picture	48t, 19.8x4.4x1.8m, 1d, 144hp, 9kts, 11p; radar	

© Ivan Gogin, 2016

[home](#)[World navies yesterday](#)[1960](#)

Hungary 01 January 1960

RIVER CRAFT



PGR	PM1	1	PN34	1949		38t, 28.0x3.7x1.1m, 2d, 420hp, 13.5kts, 16p; 13belt, 20deck, 30CT; 2x1-37/73, 1x1-82/11 mortar
	PN21	1	PN22	1951		52(21)-74(22)t, 28.0(21)-33.2(22)x3.9x0.6(21)-1.1(22)m, 2d, 420hp, 13.5kts, 16p; 30belt, 30deck, 30CT; 1x1-37/73, 1x1-81/11 mortar
	PN31	3	PN31-33	1952-56		92t, 33.0x4.8x1.0m, 2d, 900hp, 13.4kts; 30belt, 30deck, 30CT; 2x1-37/73, 1x1-12.7
MLB	AM1	1	AM3	1940		20t, 14.3x3.7x0.6m, 2d, 150hp, 11.6kts, 3p; 6mines or minesweeping gear
	AN1	47	AN1, 2, 542-001-542-045	1948-56		12t, 13.4x3.8x0.6m, 2d, 220hp, 9kts, 7p; 1x1-12.7, 4mines or minesweeping gear or charge lines
MSB	GAM1	12	GAM1-12	1948	No picture	10t, 2d; 1x1-14.5, minesweeping gear

© Ivan Gogin, 2016

[home](#)[World navies yesterday](#)[1960](#)

Iceland 01 January 1960

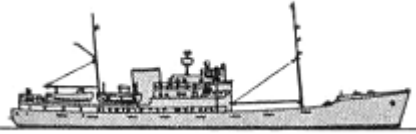
COAST GUARD

PS	Þór	1	1	Þór	1951		920t, 62.8x9.5x4.0m, 2d, 3200hp, 17kts, 22p; 2x1-57/40; radar
APS	-	1	1	Ægir	1929		507t
PC	Albert	1	1	Albert	1957		200brt, 33.9xxm, 1d, 650hp, 12.5kts, 15p; 1x1-47/40; radar
APC	-	1	1	María Júlía	1950		138t
APB	-	2	1	Sæbjörg	1937		98t
			2	Gautur	1938		72t



© Ivan Gogin, 2016

[home](#)[World navies yesterday](#)[1960](#)

India 01 January 1960

PRINCIPAL SURFACE COMBATANTS

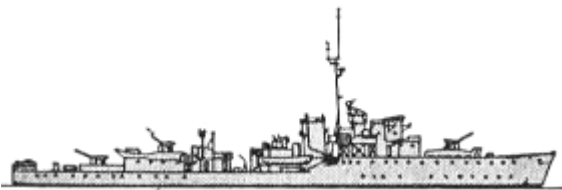
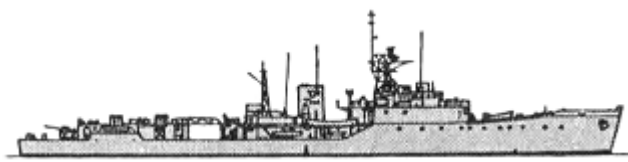
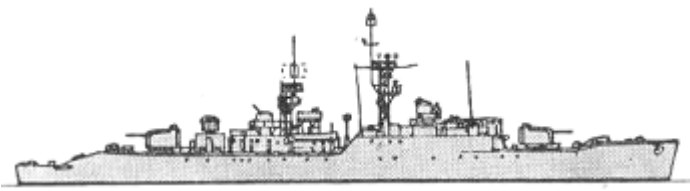
CL	Leander	1	C78	Delhi	1933		9740t, 169.0x17.0x6.1m, 6b,4gst, 72000hp, 32.5kts, 680p; 76belt, 51deck, 25turrets; 3x2-152/50, 4x2-102/45, (4x2+6x1)-40/60; type 274, 285, 277Q, 293, 960 radars
	Fiji	1	C60	Mysore	1940		11040t, 169.3x18.9x6.3m, 4b,4gst, 72500hp, 31.5kts, 730p; 89belt, 51deck, 51turrets; 3x3-152/50, 4x2-102/45, (5x2+2x1)-40/60; type 274, 275, 960, 277Q, 293 radars
DD R		3	D115	Rana	1942		2424t, 109.2x10.9x4.3m, 2b,2gst, 40000hp, 36kts, 225p; 4x1-120/45, 4x1-40/60, 1x4-40/39, 2x2-20/70, 2x4-533TT, 4dct, 3dcr; type 272, 282, 285, 291, 293 radars, type 123A, 127 sonars
			D141	Ranjit	1942		
			D209	Rajput	1942		
Black Swan	2	F110	Cauvery	1943		1950t, 91.3x11.7x3.5m, 2b,2gst, 4300hp, 219p; 3x2-102/45, 2x1-40/60(46), (4x2+2x1)-20/70, 8dct, 2dcr; type 272, 285, 291 radars, type 123A, 177 sonar	
		F46	Kistna	1943			
River	1	F256	Tir	1943		2180t, 91.8x11.2x3.9m, 2b,2vte, 5500hp, 20kts, 140p; 1x1-102/40, 1x1-40/60, 2x1-20/70; type 272, 291 radars, sonars	
		D92	Godavari	1942		1610t, 85.3x9.6x3.8m, 2b,2gst, 19000hp, 27kts, 168p; 3x2-102/45,	
		D93	Gomati	1941			

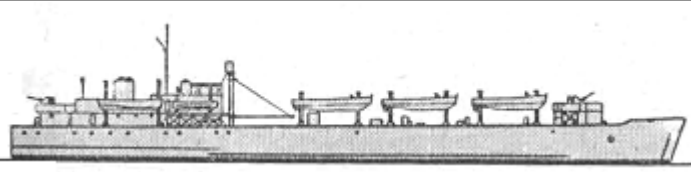

FF	Hunt 2	3	D94	Ganga	1941		1x4-40/39, 4x1-20/70, 2dct, 3dcr; type 271, 285, 291 radars, type 123A, 127 sonars
	type 14	3	F144	Kirpan	1959		1535t, 94.5x10.7x4.7m, 2b,1gst, 15000hp, 27kts, 140p; 3x1-40/60, 2x3-305 Limbo ASWRL; type 974, 291 radars, type 174, 170, 162 sonars
			F146	Kuthar	1959		
			F149	Khukri	1958		
type 41	1	F31	Brahmaputra	1958		2520t, 103.6x12.2x3.6m, 8d(2), 14400hp, 25kts, 205p; 2x2-120/45, 1x2-40/60, 1x3-305 Squid ASWRL; type 275, 262, 960, 974, 992Q, 978, 993 radars, type 170, 174, 162 sonars	
type 12	1	F140	Talwar	1959		2560t, 112.7x12.5x3.9m, 2b,2gst, 30000hp, 29kts, 231p; 1x2-120/45, 1x2-40/60, 2x3-305 Limbo ASWRL; type 275, 293, 277, 903, 974/978 radars, type 162, 170, 174/177 sonars	

AMPHIBIOUS

LST	LST(3)	1	L3011	Magar	1945		4980t, 105.9x16.8x3.8m, 2b,2vte, 5500hp, 13.5kts, 111p; 2x2-40/60, (2x2+2x1)-20/70; 5 LCA, 1 LCT(6), 15tanks, 170troops
-----	--------	---	-------	-------	------	---	---

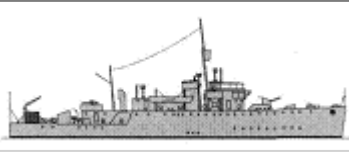
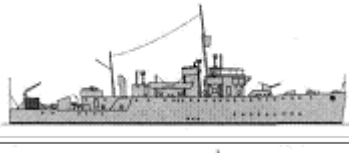
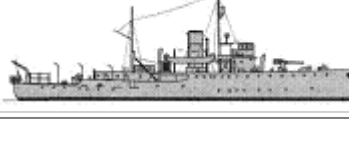
MINE WARFARE

MSO	Bangor VTE	2	M228	Konkan	1942		875t, 54.9x8.7x3.1m, 2b,2vte, 2400hp, 16.5kts, 87p; 1x1-76/45, 3x1-20/70, 4dct, 2dcr, sweeps, radar
			M197	Rajputana	1942		
	Bangor turbine	1	M180	Rohilkand	1943		780t, 53.0x8.7x3.0m, 2b,2gst, 2000hp, 16.5kts, 87p; 1x1-76/40, 3x1-20/70, 4dct, 2dcr, sweeps, radar
Bathurst	3	M243	Bengal	1942		790t, 56.7x9.5x3.0m, 2b,2vte, 2000hp, 16kts, 90p; 1x1-76/40, 1x1-40/60, 2x1-20/70, 4dct, 2dcr, sweeps; radar	
		M249	Bombay	1942			
		M237	Madras	1942			
MMS1	1	M154	MMS154	1946		295t, 36.4x7.1x2.7m, 1d, 500hp, 11kts, 20p; 2x1-20/70, sweeps	

							
MSC	Ton	4	M1190	Cuddalore	1955		425t, 46.3x8.8x2.5m, 2d, 3000hp, 15kts, 29p; 1x1-40/60, 1x2-20/70, sweep; type 978 radar
			M1191	Cannanore	1956		
			M1197	Karwar	1956		
			M1201	Kakinada	1956		
MSI	Ham	2	M2705	Bimlipatan	1954		159t, 32.5x6.6x1.7m, 2d, 1100hp, 14kts, 15p; 1x1-20/70, sweep; type 978 radar
			M2707	Bassein	1954		

© Ivan Gogin, 2015



[home](#)[World navies yesterday](#)[1960](#)

Indonesia 01 January 1960

SUBMARINES

SS	pr. 613	2	401	Tjakra	1954		1045/1342t, 76.0x6.3x4.6m, 2d/em, 4000/2700hp, 18.3/13.1kts, 55p, 170m; 6-533TT; Flag radar, Tamir-5L, Feniks sonars, Nakat ECM
			402	Nanggala	1954		

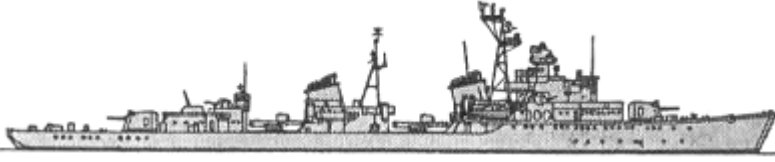

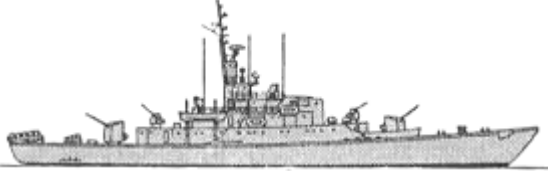
PRINCIPAL SURFACE COMBATANTS

DD	N	1	806	Gajah Mada	1942		2384t, 108.7x10.9x4.2m, 2b,2gst, 40000hp, 36kts, 218p; 3x2-120/45, 1x4-40/39, 4x1-20/70, 2x5-533TT, 4dct, 2dcr; type 271, type 285, type 290 radars, sonar	
			pr. 30BK	201	Siliwangi			1951
				203	Sandjaja			1951
				204	Sawunggaling			1951
			304	Sultan Iskandar Muda	1951		3066t, 120.5x12.0x4.3m, 4b,2gst, 60000hp, 35.5kts, 286p; 2x2-130/51, 1x4-57/75, 2x2-37/70, 2x5-533TT, 6dct, 2dcr, 60mines; Fut-N, P-10, Fut-B, Rym-1, Redan, Vympel-2 radars, Gerkules sonar	
FF	Almirante Clemente	2	355	Imam Bondjol	1958			
			356	Soerapati	1958			
FS	Albatros	2	253	Sultan Hasanudin	1958			
			257	Pattimura	1958		1200t, 82.4x10.4x2.7m, 3d, 6900hp, 22kts, 110p; 2x1-76/62, 2x2-40/70, 2x24-178 Hedgehog ASWRL, 4dct, 1dcr; NWS-1, CWS-1 radars, QCU-2 sonar	

PATROL AND COASTAL COMBATANTS

PS	Bathurst	3	254	Radjawali	1941		790t, 56.7x9.5x3.0m, 2b,2vte, 2000hp, 16kts, 90p; 1x1-102/44, 1x1-40/60, 4x1-20/70, 4dct, 2dcr, minesweeping gear; radar, sonar
			255	Banteng	1942		

MINE WARFARE

MSI	Djombang	4	1	Djombang	1941		175t, 34.7x5.7x1.9m, 1d, 360hp, 12.5kts, 14p; minesweeping gear	
			2	Djampea	1941			
			3	Enggano	1941			
			4	Flores	1943			
	R		10	501	Pulau Rani	1954		139t, 39.3x5.7x1.5m, 2d, 2800hp, 24.6kts, 26p; 1x1-40/60, 2x1-20/70, minesweeping gear; radar
				502	Pulau Roma	1954		
				503	Pulau Rass	1955		
				504	Pulau Roti	1955		
				505	Pulau Rupert	1955		
				506	Pulau Rangsang	1956		
				507	Pulau Rindja	1956		
				508	Pulau Rempang	1956		
				509	Pulau Rengat	1957		
				510	Pulau Rusa	1957		

MARINE POLICE

PC	DKN901	5	DKN901		1958	No picture	160t, 39.0x5.8x1.6m, 2d, 3000hp, 24.5kts; 4x1-20/80; radar
			DKN902		1958		
			DKN903		1958		
			DKN904		1959		
			DKN905		1959		

© Ivan Gogin, 2016



[home](#)[World navies yesterday](#)[1960](#)

Iran 01 January 1960

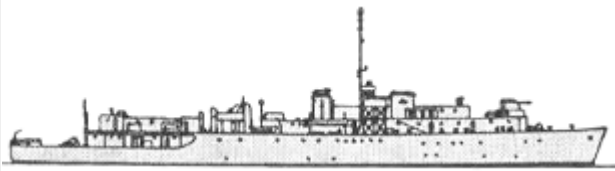
PRINCIPAL SURFACE COMBATANTS

FF	Loch	1	1	Babr	1945		2260t, 93.6x11.8x3.8m, 2b,2vte, 5500hp, 19.5kts, 177p; 1x2-102/45, 4x1-40/60; type 277, 291 radars
----	------	---	---	------	------	--	--

PATROL AND COASTAL COMBATANTS

PC	USCG95	4	PC61	Keyvan	1956		107t, 29.0x6.2x2.0m, 4d(2), 2200hp, 20kts, 15p; 1x1-40/60, 2x4-178 Mousetrap ASWRL, 2dcr; radar, sonar
			PC62	Mehran	1959		
			PC63	Tiran	1957		
			PC64	Mahan	1959		
PB	Azerbaijan	3	1	Babolsar	1933	No picture	32t, 20.9x3.8x1.1m, 2d, 300hp, 14kts, 15p; 1x1-45/46, 1x1-12.7
			2	Gorgan	1933		
			3	Sefid-Rud	1933		
	HDML	2	FDB65	Tahmadou	1944		54t, 22.0x4.8x1.4m, 2d, 260-300hp, 11-11.8kts, 10p; 2x1-20/70, 2dcr; type 291 radar
			FDB66	Asalon	1941		
	Azar	9	1	Azar	1954		65t, 27.5xxm, 2d, 1000hp, 22kts, 10p; 1x2-12.7; radar
			2	Chahab	1954		
			3	Darakhsh	1954		
			4	Navak	1954		
			5	Peykan	1955		
6			Tondar	1955			
7	Tonbad	1955					
8	Toufan	1955					
9	Tousan	1955					

AMPHIBIOUS

LCU	LCI(L)	2	41	Hengam	1944		385t, 48.9x7.2x1.6m, 8d(2), 2320hp, 15.5kts, 29p; 5x1-20/70; 209troops; SO radar
-----	--------	---	----	--------	------	--	--

[home](#)[World navies yesterday](#)[1960](#)

Iraq 01 January 1960

PATROL AND COASTAL COMBATANTS

PT	pr. 183	2	212	Tamouz	1959		67t, 25.5x6.2x1.2m, 4d, 6000hp, 43kts, 14p; 2x2-25/82, 2-533TT, 2dcr; Zarnitsa radar
			213	Al Adrisi	1959		
PBR	Thornycroft	4	1	Abd Al Rahman	1937	No picture	67t, 30.5x5.2x0.9m, 2d, 280hp, 12kts; 1x1-94/12, 2x1-81/12 mortars
			2	Al Ghazi	1937		
			3	Dat Al Diyari	1937		
			4	Jannada	1937		

© Ivan Gogin, 2016

[home](#)[World navies yesterday](#)[1960](#)

Ireland 01 January 1960

PRINCIPAL SURFACE COMBATANTS

FS	Flower	3	P01	Macha	1942		1170t, 62.5x10.1x4.1m, 2b,1vte, 2750hp, 16.5kts, 109p; 1x1-102/45, 1x1-40/39(01,03), 2x1-20/70, 1x24-178 Hedgehog ASWRL(02,03), 2dct, 2dcr; type 286, 290 radars, sonar
			P02	Maev	1941		
			P03	Cliona	1941		

© Ivan Gogin, 2016



[home](#)[World navies yesterday](#)[1960](#)

Israel 01 January 1960

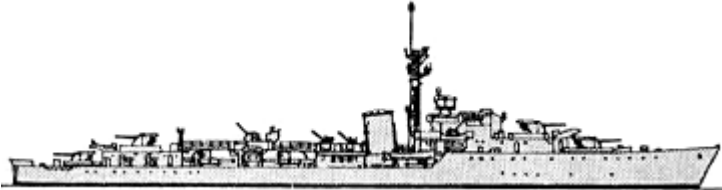

SUBMARINES

SS	S	2	Tz71	Tanin	1945		990t, 66.1x7.2x4.3m, 2d/em, 1900/1300hp, 14.7/9kts, 48p, 110m; 1x1-102/40, 1x1-20/70, 6-533TT; type 291W radar, sonars
			Tz73	Rahav	1945		

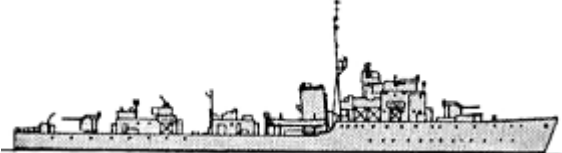
PRINCIPAL SURFACE COMBATANTS

DD	Z	2	K40	Eilath	1944		2575t, 110.6x10.9x4.4m, 2b,2gst, 40000hp, 36.7kts, 222p; 4x1-114/45, (1x2+4x1)-40/60, 2x4-533TT, 4dct, 2dcr; type 275, type 277, type 282, type 291 radars, type 123A, type 127 sonars
			K42	Yaffa	1944		
FF	River Canadian	1	K30	Misgav	1944		2180t, 91.8x11.2x3.9m, 2b,2vte, 5500hp, 20kts, 140p; (1x2+1x1)-102/45, 1x1-76/40, 4x2-20/70, 1x24-178 Hedgehog ASWRL, 8dct, 2dcr; type 268, type 272, type 275, type 291 radars, sonars
	Hunt 1	1	K38	Haifa	1940		1450t, 85.3x8.8x3.8m, 2b,2gst, 19000hp, 28kts, 147p; 2x2-102/45, 2x1-40/39, 4x1-20/70, 2dct, 1dcr; type 285 radar, type 123A, 177 sonars

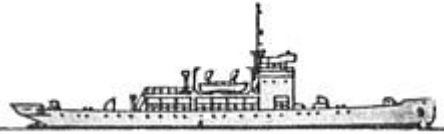
PATROL AND COASTAL COMBATANTS

PSO	Northland	1	A16	Matzpen	1927		2150t, 66.0x11.9x4.2m, 2dg,1em, 1000hp, 11.5kts, 107p; 1x1-76/50, 10x1-20/70, 4dct; SC-1, SF radars, QCJ-3 sonar
PC	PC 173ft	1	K22	Nogah 2	1944		463t, 52.9x7.1x3.3m, 2d, 2880hp, 19kts, 65p; 1x1-76/50, 1x1-40/60, 3x1-20/70, 2x4-178 Mousetrap ASWRL, 2dct, 2dcr; SO radar, sonar
	Yarden	2	M42	Yarden	1956		109t, 30.5x6.1x1.9m, 2d, 22kts, 16p; 2x1-20/70; radar

							
PT	Vosper 70ft	8	T201	Nasher	1944		47t, 22.3x5.9x1.3m, 3pe, 4200hp, 40kts, 16p; 1x1-40/60, 1x2-20/70, 2-450TT, 2dcr; type 291 radar
			T202	Ait	1944		
			T203	Ayah	1944		
			T204	Daya	1944		
			T209	Shaldag	1944		
			T210	Lilit	1944		
			T211	Yinshof	1944		
			T212	Tinshemett	1944		
	Baz	4	T205	Baz	1951		62t, 26.0x6.3x1.5m, 4pe(2), 4600hp, 42kts, 14p; 1x1-40/60, (1x2+2x1)-20/70, 2-450TT
			T206	Takhmas	1951		
			T207	Peres	1952		
			T208	Yisaor	1952		
	Ophir	3	T150	Ophir	1956		40t, 21.3x5.2x1.5m, 2pe+1d; 4150hp, 40kts; 1x1-40/60, 1x2-20/70, 2-450TT; radar
T151			Sheva	1956			
T152			Tarshish	1956			
PB	Fairmile B	1	M17	HaPortzim	1942		86t, 34.8x5.6x1.5m, 2pe, 1200hp, 18kts, 16p; 3x1-20/70, 2dcr; type 286 radar, sonar
	HDML	3	M21	Dror	1943	No picture	54t, 22.0x4.8x1.4m, 2d, 320hp, 12kts, 12p; 2x1-20/70, 2dcr
			M23	Saar	1943		
			M35	Tirza	1943		

AMPHIBIOUS



LCM	LCM(6)	2	Makh-32, 38	1957-1959		56t, 17.1x4.3x1.2m, 2d, 450hp, 9kts, 5p; 2x1-12.7; 1tank
-----	--------	---	-------------	-----------	---	--

© Ivan Gogin, 2016

[home](#)[World navies yesterday](#)[1960](#)

Italy 01 January 1960



SUBMARINES



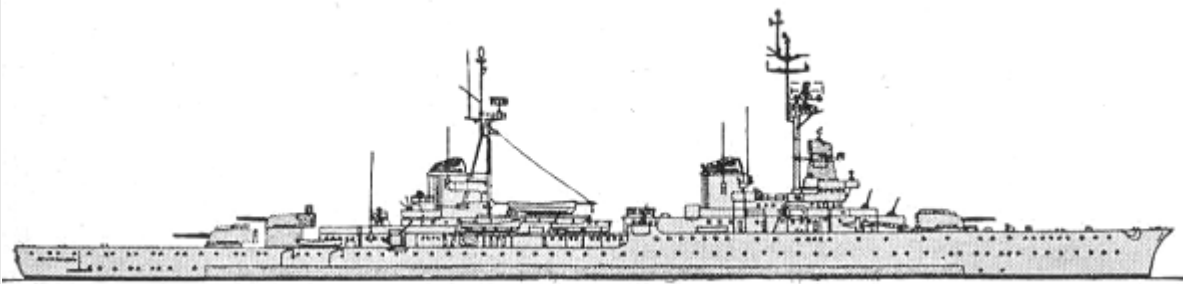
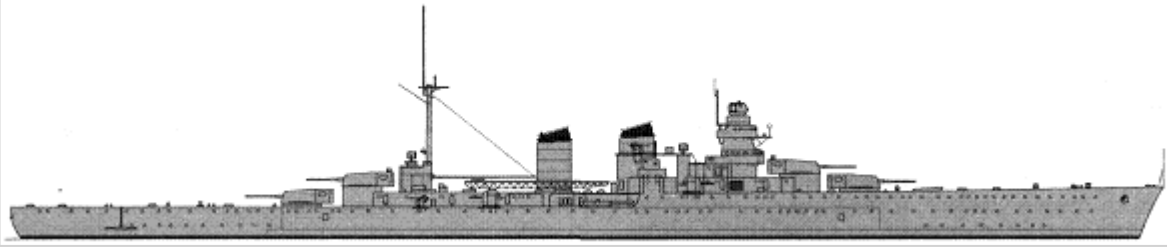
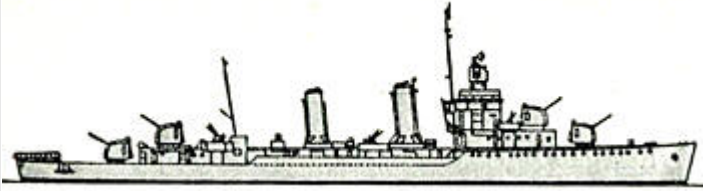

SS	Acciaio	1	S501	Giada	1941		701/865t, 60.2x6.4x4.8m, 2d/em, 1350/800hp, 14.7/7.9kts, 54p, 80m; 6-533TT
	Flutto	1	S502	Vortice	1943		905/1068t, 63.2x7.0x4.9m, 2d/em, 2400/1350hp, 17/8kts, 50p, 120m; 6-533TT
	Gato GUPPY IB	2	S510	Leonardo da Vinci	1943		1830/2440t, 93.6x8.2x5.2m, 4dg,4em(2), 4610/5400hp, 18/15kts, 82p, 90m; 10-533TT; BQR-2, BQS-2, SQR-3 sonars, SS, SV, BPS-1 radars
S511			Enrico Tazzoli	1942			

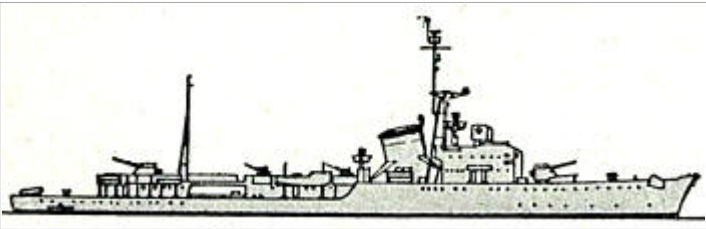
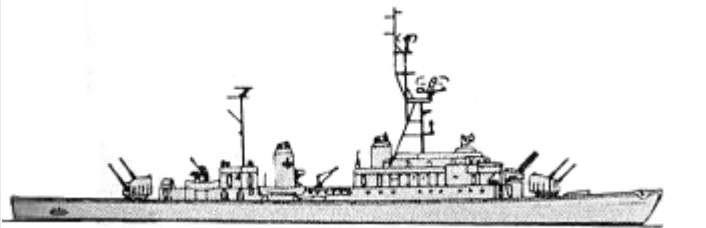
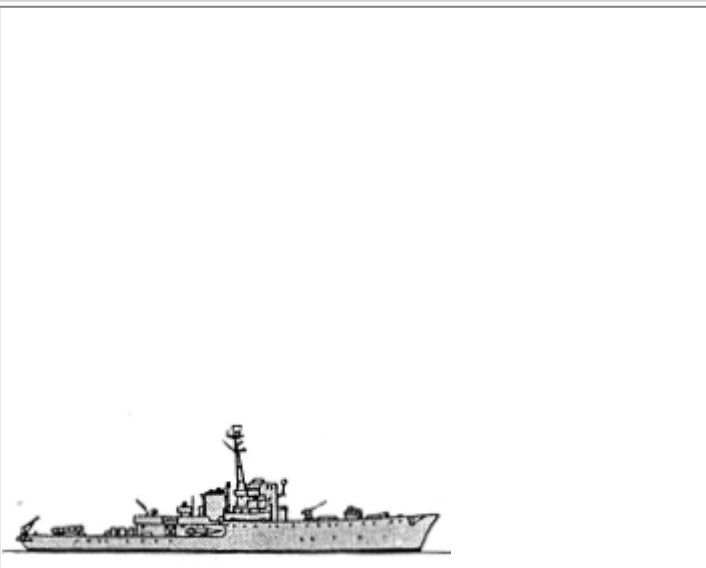
PRINCIPAL SURFACE COMBATANTS



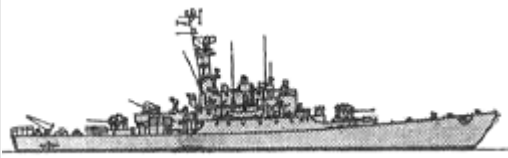

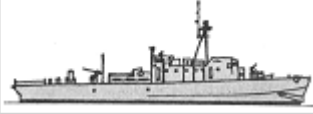

CL	Condottieri batch 3	1	C552	Raimondo Montecuccoli	1935		8994t, 182.2x16.6x5.4m, 4b,2gst, 75000hp, 37kts, 650p, 85belt, 30decks, 70turrets, 100CT; 3x2-152/53, 2x2-100/47, 4x2-40/60, 4x1-20/70, 2dct, 146mines; SPS-6, SPS-12 radars
	Condottieri batch 5	2	C550	Luigi di Savoia Duca degli Abruzzi	1937		11575(550)-11117(551)t, 187.0x18.9x6.8m, 6b,2gst, 85000hp, 29kts, 692p; 130belt, 55decks, 135turrets, 140CT; (2x3+2x2)-152/55, 2x2-100/47, (4x4+4x2)-40/60, 120mines; type 286, SPS-6C(550), SC(550), SO-8(551), SK-2(551) radars
C551			Giuseppe Garibaldi	1937			
	Laffey	1	D553	Artigliere	1942		2600t, 106.2x11.0x4.9m, 4b,2gst, 50000hp, 35kts, 208p; 4x1-127/38, 2x2-40/60, 7x1-20/70, 6dct, 2dcr; SC, Mk4 radars, sonar
							2572t, 106.2x11.0x4.0m, 4b,2gst, 50000hp, 35kts, 208p;

DD	Gleaves	1	D554	Aviere	1941		4x1-127/38, (2x4+2x2)-40/60, 2x2-20/70, 6dct, 2dcr; SC, Mk4 radars, sonar
	Capitani Romani	2	D562	San Giorgio	1943		5600t, 142.2x14.4x6.4m, 4b,2gst, 110000hp, 38.5kts, 494p; 20turrets, 15CT; 3x2-127/38, (3x4+4x2)-40/60, 1x3-305 Menon ASWRL, 4dct, 1dcr; SPS-6, SG-6B, Mk12/22 radars, SQS-11 sonar
			D563	San Marco	1956		
Impetuoso	2	D558	Impetuoso	1958		3810t, 127.6x13.2x4.5m, 4b,2gst, 65000hp, 34kts, 315p; 2x2-127/38, (2x4+4x2)-40/60, 2-533TT, 1x3-305 Menon ASWRL, 4dct, 1dcr; SPS-6, SG-6B, 4x SPG-34, Mk25 radars, SQS-11 sonar	
		D559	Indomito	1958			
FF	Spica/Perseo	1	F557	Sagittario	1936		1005t, 80.4x8.2x3.1m, 2b,2gst, 19000hp, 34kts, 99p; 3x1-100/47, 4x1-20/70, 3x2-20/65, 2x2-450TT, 4dct, 28mines
	Spica/Alcione	1	F552	Libra	1938		1035t, 80.4x7.9x3.1m, 2b,2gst, 19000hp, 34kts, 99p; 2x1-40/60, 4x1-20/70, 3x2-20/65, 1x24-178 Hedgehog ASWRL, 4dct, 28mines
	Pegaso	2	F558	Orsa	1938		1575t, 89.3x9.7x3.7m, 2b,2gst, 16000hp, 28kts, 168p; 6x1-40/60, 1x24-178 Hedgehog AWRL, 2dct, 290mines
			F559	Orione	1938		
	Cannon	3	F590	Aldebaran	1944		1602t, 93.3x11.2x3.2m, 4dg,2em, 6000hp, 21kts, 186p; 3x1-76/50, 3x2-40/60, 8x1-20/70, 1x24-178 Hedgehog ASWRL, 8dct, 2dcr; SPS-6, SMA radars, QGB sonar
			F591	Altair	1944		
F592			Andromeda	1943			
Maestrale	1	F556	Grecale	1934		2207t, 106.7x10.2x3.3m, 3b,2gst, 44000hp, 38kts, 190p; 2x2-120/50, 6x1-40/60, 2x1-20/65, 1x24-178 Hedgehog ASWRL, 6dct, 52mines	



	Soldati group 1	1	F552	Carabiniere	1938		2460t, 106.7x10.2x3.5m, 3b,2gst, 48000hp, 31kts, 206p; (1x2+1x1)-120/50, 3x2-40/60, 2x1-20/65, 1x3-533TT, 1x24-178 Hedgehog ASWRL, 2dct, 48mines
	Canopo	4	F551	Canopo	1958		2250t, 103.1x12.0x3.8m, 2b,2gst, 22000hp, 26kts, 207p; 2x2-76/62, 2x2-40/70, 2x1-533TT, 1x3-305 Menon ASWRL, 4dct; MLA-1, SG-6B, MLT-4 radars, SQS-11A sonar
F553			Castore	1957			
F554			Centauro	1957			
F555			Cigno	1957			
FS	Gabbiano	22	F547	Crisalide	1952		728t, 64.4x8.7x2.5m, 2d/em, 3500/300hp, 18/6kts, 110p; 1x2-40/60(549,571,578-579), (1x2+1x1)-40/60(547,548,561, 562,564,566, 568,570,578), 2x2-40/60(563,565,567, 569,572-577,579), 2x1-20/70(549,571), 2x1-450TT, 1x24-178 Hedgehog ASWRL(547-549,561,562 ,564-574,576-579), 4dct, 1dcr(563,565,567 ,569,572-577,579), 2dcr(547- 549,561,562 ,564,566,568 ,570,571,578), SO-13(547- 549,561, 562,566-571,574), SPS-6(563,575,579), NSM- 8(565,572,573, 576-578) radar, QCU-2 sonar
			F548	Farfalla	1953		
			F549	Bombarda	1951		
			F561	Ibis	1943		
			F562	Minerva	1943		
			F563	Danaide	1943		
			F564	Scimitarra	1943		
			F565	Sibilla	1943		
			F566	Gru	1943		
			F567	Ape	1943		
			F568	Driade	1943		
			F569	Chimera	1943		
			F570	Urania	1943		
			F571	Gabbiano	1942		
			F572	Flora	1943		
			F573	Pomona	1943		
			F574	Pellicano	1943		
			F575	Cormorano	1943		
			F576	Folaga	1943		
			F577	Fenice	1943		
			F578	Baionetta	1943		
			F579	Sfinge	1943		
	Algerine	1	F560	Alabarda	1943		1258t, 68.6x10.8x3.1m, 2b,2vte, 2400hp, 16.5kts, 138p; (1x2+2x1)-40/60, 4dct, 1dcr; SO-13 radar
	Albatros	3	F543	Albatros	1955		950t, 76.3x9.7x2.8m, 2d, 5200hp, 19kts, 110p; 2x1-76/62, 1x2-40/70, 2x24-178 Hedgehog ASWRL, 4dct, 1dcr; MLN-1A radar, QCU-2 sonar
F544			Alcione	1955			
F545			Airone	1955			



						
type 1943	2	F541	Gazzella	1944		821t, 67.8x9.0x2.3m, 2b,2vte, 2700hp, 17kts, 96p; 1x1-100/47, 3x1-40/60, 2dct; radar
		F542	Daino	1945		
Sentinella	1	F598	Sentinella	1956		340t, 49.7x6.6x2.1m, 4d(2), 9000hp, 30kts, 60p; 1x2-40/60, 2-450TT, 1x24-178 Hedgehog ASWRL, 2dct
Vedetta	1	F597	Vedetta	1955		400t, 53.1x7.3x3.1m, 4d(2), 3240hp, 19kts, 62p; 2x1-40/60, 2x1-20/70, 1x24-178 Hedgehog ASWRL, 2dct, 1dcr; QCU-2 sonar



PATROL AND COASTAL COMBATANTS

PT	MS11	3	P471-473	MS471-473	1942		63-64t, 28.0x4.3x1.6m, 3pe, 3450hp, 32kts, 19p; 2x1-20/65, 2-533TT, 8dc
	MS51	6	P474, 475, 481-484	MS474, 475, 481-484	1943		66t, 28.0x4.3x1.6m, 3pe, 3450hp, 31kts, 19p; 3x2-20/65, 2-533TT, 2-450TT, 8dc
	Higgins	7	P441-444, 451-453	MAS441-444, 451-453	1942 - 1943		48t, 24.0x6.1x1.6m, 3pe, 4500hp, 41kts, 17p; 1x1-40/60, 3x1-20/70, 2-450TT; SCR-517A radar
	Vosper	5	P422, 431, 432, 462, 463	MAS422, 431, 432, 462, 463	1943 - 1944		45t, 22.1x5.9x1.7m, 3pe, 3375hp, 39kts, 12p; 5x1-20/65, 2-450TT; SCR-517A radar
	S38	1	P485	MC485	1942		115t, 34.9x5.3x1.7m, 3d, 6000hp, 39kts, 22p; 2x1-40/60, 2-533TT
	MC490	1	P490	MC490	1955		190t, 39.4x5.8x1.7m, 4d, 10000hp, 36kts, 39p; 2x1-40/60, 2-533TT

MINE WARFARE SHIPS



Dance	4	M5307	DR307	1941		770t, 50.0x8.4x3.4m, 1b,1vte, 850hp, 12.2kts, 40p; 3x1-20/70, 2dct, 2dcr, mechanical sweeps
		M5308	DR308	1941		
		M5312	DR312	1940		
		M5316	DR316	1940		
Shakespearian	1	M5310	DR310	1941		770t, 50.0x8.4x3.4m, 1b,1vte, 850hp, 12.2kts, 40p; 3x1-20/70, 4dct, 2dcr, mechanical sweeps
		M5301	DR301	1941		
		M5302	DR302	1941		
		M5303	DR303	1942		
		M5304	DR304	1942		





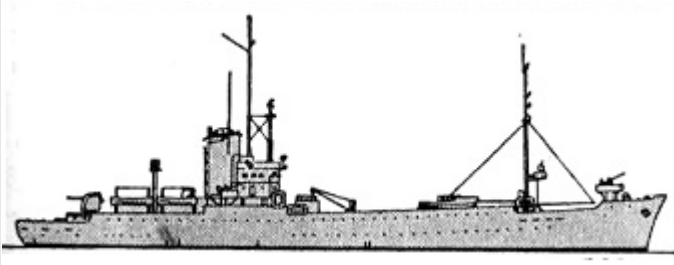
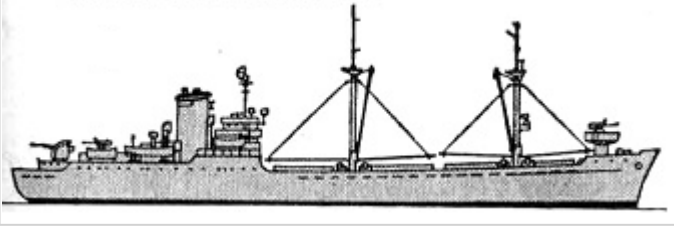
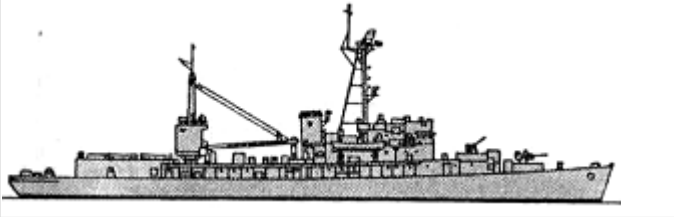
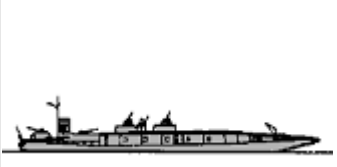
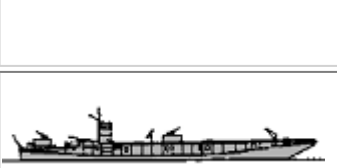
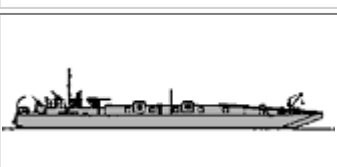

MSO	Isles	11	M5305	DR305	1942		770t, 50.0x8.4x3.4m, 1b,1vte, 850hp, 12.2kts, 40p; 3x1-20/70, 4dct, 2dcr, mechanical sweeps
			M5306	DR306	1942		
			M5309	DR309	1943		
			M5311	DR311	1942		
			M5313	DR313	1942		
			M5314	DR314	1942		
			M5315	DR315	1942		
	Aggressive	4	M5430	Salmone	1956		735t, 52.3x10.4x4.0m, 2d, 1600hp, 14kts, 70p; 1x1-40/60, acoustic, magnetic, mechanical sweeps; SPS-53 radar, UQS-1 sonar
			M5431	Storione	1956		
			M5432	Sgombro	1957		
			M5433	Squalo	1957		
	YMS	17	M5400	Anemone	1942		250t, 41.5x7.5x2.4m, 2d, 800hp, 15kts, 60p; 1x1-76/50, 2x1-20/70, mechanical, acoustic, magnetic sweeps
			M5401	Azalea	1943		
			M5402	Begonia	1943		
			M5403	Biancospino	1942		
M5404			Dalia	1943			
M5405			Fiordaliso	1943			
M5406			Gardenia	1943			
M5407			Geranio	1942			
M5408			Magnolia	1943			
M5409			Mughetto	1942			
M5410			Narciso	1942			
M5411			Oleandro	1942			
M5412			Orchidea	1943			
M5413			Primula	1943			
M5414			Tulipano	1943			
M5415			Verbena	1943			
M5416			Gladiolo	1943			
MSB			M5501	Abete	1953		
			M5502	Acacia	1953		
			M5503	Betulla	1953		
			M5504	Castagno	1955		
			M5505	Cedro	1954		
			M5506	Cillegio	1953		
			M5507	Faggio	1953		
			M5508	Frassino	1953		
			M5509	Gelso	1953		
			M5510	Larice	1953		
			M5511	Noce	1954		
			M5512	Olmo	1954		

			M5513	Ontano	1954		
			M5514	Pino	1954		
			M5515	Pioppo	1954		
			M5516	Platano	1954		
			M5517	Quercia	1954		
	Adjutant	35	M5521	Bambù	1956		400t, 44.3x8.1x2.1m, 2d, 1200hp, 13kts, 39p; 1x2-20/70, acoustic, magnetic, mechanical sweeps; SPS-53 radar, UQS-1 sonar
		M5522	Ebano	1956			
		M5523	Mango	1956			
		M5524	Mogano	1957			
		M5525	Palma	1957			
		M5526	Rovere	1957			
		M5527	Sandalo	1957			
		M5531	Agave	1955			
		M5532	Alloro	1955			
		M5533	Edera	1955			
		M5534	Gaggia	1956			
		M5535	Gelsomino	1955			
		M5536	Giaggiolo	1956			
		M5537	Glicine	1956			
		M5538	Loto	1957			
		M5539	Mirto	1955			
		M5540	Timo	1956			
		M5541	Trifoglio	1955			
		M5542	Vischio	1956			
			M5450	Aragosta	1957		
			M5451	Arsella	1957		
			M5452	Astice	1957		
			M5453	Attinia	1957		
			M5454	Calamaro	1957		
			M5455	Conchiglia	1957		
			M5456	Dromia	1957		
			M5457	Gambero	1957		
			M5458	Granchio	1957		
			M5459	Mitilo	1957		188t, 32.5x6.4x1.8m, 2d, 1000hp, 15kts, 14p; 1x1-20/70, mechanical sweep; BX-732 radar
MSI	Ham	20	M5460	Ostrica	1957		
			M5461	Paguro	1957		
			M5462	Pinna	1957		
			M5463	Polipo	1957		
			M5464	Porpora	1957		
			M5465	Riccio	1957		
			M5466	Scampo	1957		

			M5467	Seppia	1957		
			M5468	Tellina	1957		
			M5469	Totano	1957		
MSB	RDV	2	P403	DV113	1945	No picture	110t, 34.0x5.8x1.4m, 2d, 2000hp, 17kts, 24p; 1x1-20/65, mechanical sweeps
			P406	DV116	1945		

AMPHIBIOUS

LPA	Stromboli	1	A5329	Stromboli	1953		6160t, 102.0x14.0x7.0m, 3b,1gst, 3700hp, 13.5kts; 1x1-100/47, 4x1-40/60; 4 LCM, 1 LCVP, cargo, troops
LKA	Vesuvio	1	A5330	Vesuvio	1955		6160t, 102.0x14.0x7.0m, 3b,1gst, 3700hp, 13.5kts; 1x1-100/47, 4x1-40/60; 4 LCM, 1 LCVP, cargo, troops
LPR	Barnegat	1	A5301	Pietro Cavezzale	1943		2800t, 94.7x12.5x3.7m, 4dg,2em, 6080hp, 16kts, 200p; 1x1-76/50, 1x2-40/60, diving equipment, RIBs; SPS-6, Jason radars
LCU	MZ-A	6	A5341	MTC1001	1942		239t, 47.0x6.5x1.0m, 3d, 450hp, 11kts, 13p; 1x1-76/40, 2x1-20/65; 200men
			A5342	MTC1002	1942		
			A5343	MTC1003	1942		
			A5344	MTC1004	1942		
			A5345	MTC1005	1942		
			A5346	MTC1006	1942		
	MZ-B	3	A5347	MTC1007	1943		279t, 46.5x6.5x1.0m, 3d, 450hp, 11kts, 13p; 1x1-76/40, 2x1-20/65; 200men
			A5348	MTC1008	1943		
			A5349	MTC1009	1943		
	MFP-A,C	4	A5352	MTC1102	1942		220t, 47.0x6.5x1.5m, 3d, 390hp, 10.5kts, 21p; 1x1-37/83, 2x1-20/65; 3tanks
			A5353	MTC1103	1943		
			A5354	MTC1104	1942		
			A5357	MTC1107	1942		
MFP-D	1	A5350	MTC1010	1943		239t, 49.8x6.6x1.4m, 3d, 375hp, 10.3kts, 21p; 1x1-37/83, 2x1-20/65; 3tanks	
		A5351	MTC1101	1945			

	MFP-DM	2	A5355	MTC1105	1944		256t, 49.8x8.6x1.4m, 3d, 390hp, 8kts, 21p; 1x1-37/83, 2x1-20/65; 3tanks
	LCT(2)	3	A5331	MOC1201	1942		460t, 48.8x9.5x1.6m, 3d, 1380hp, 11kts, 12p; 2x1-20/70; 3tanks
A5337			MOC1207	1942			
A5338			MOC1208	1942			
	LCT(3)	4	A5332	MOC1202	1942		640t, 58.5x9.5x1.7m, 2d, 1000hp, 10.5kts, 12p; 4x1-20/70; 5tanks
A5333			MOC1203	1942			
A5334			MOC1204	1942			
A5335			MOC1205	1942			
LFR	LCS(L)3	6	L9851	Alano	1944		387t, 48.2x7.2x1.7m, 8d(2), 2320hp, 15.5kts, 71p; (2x2+1x1)-40/60, 4x1-20/70, 10x1-127 Mk7 RL; SU radar
			L9852	Bracco	1944		
			L9853	Mastino	1944		
			L9854	Molosso	1944		
			L9855	Segugio	1944		
			L9856	Spinone	1944		
	LCM(3)	20		MTM9901 - 9920	1942 - 1945		52t, 15.3x4.3x1.4m, 2d, 330hp, 8kts, 4p; 2x1-12.7; 1tank
LC	LCM(6)	9		MTM9921 - 9929	1943 - 1945		56t, 17.1x4.3x1.2m, 2d, 450hp, 9kts, 5p; 2x1-12.7; 1tank
	LCVP	20		MTP9701 - 9720	1943 - 1945		13t, 11.2x3.2x0.9m, 2d, 220hp, 8kts, 3p; 2x1-12.7; 36troops or 1light tank

[home](#)[World navies yesterday](#)[1960](#)

Japan 01 January 1960

SUBMARINES

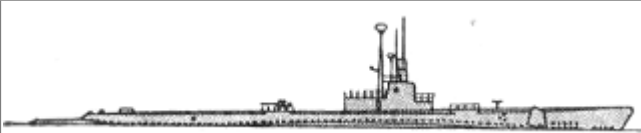
SS	Gato	1	SS501	Kuroshio	1943		1810/2410t, 95.0x8.3x4.7m, 4dg/4em(2), 5400/2740hp, 20.2/8.7kts, 60p, 90m; 1x1-127/25, 10-533TT; SS, ST, SV radars, BQR-2, BQS-2, JT sonars
----	------	---	-------	----------	------	--	---



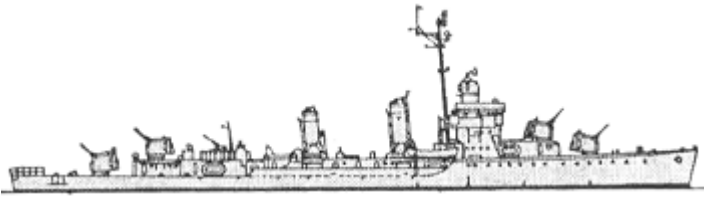
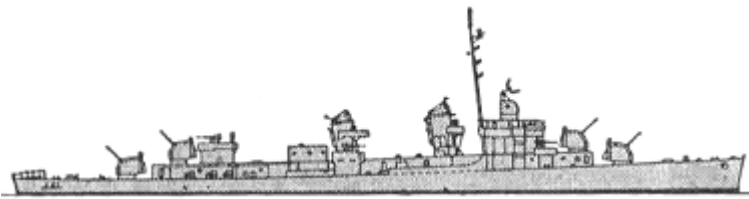
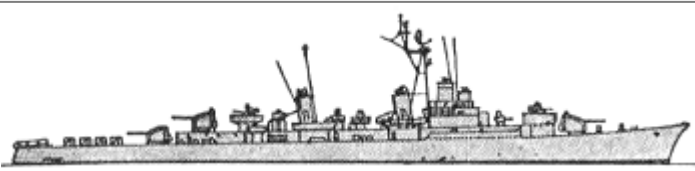
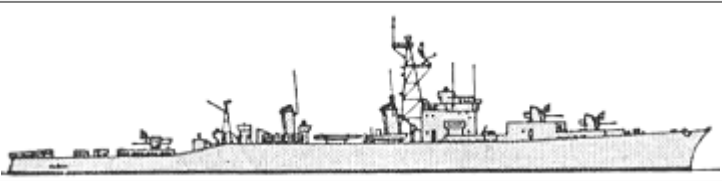
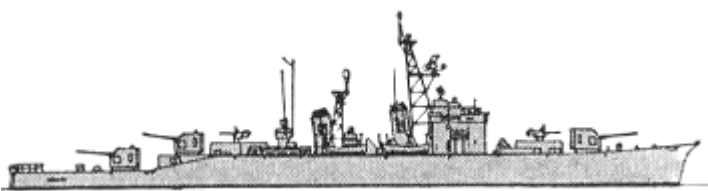

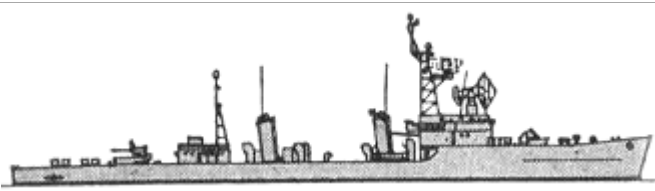
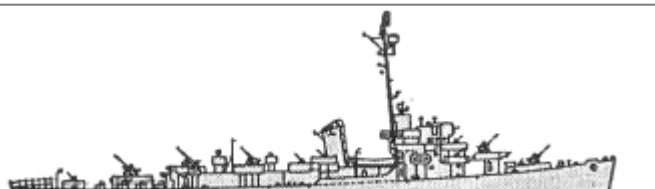
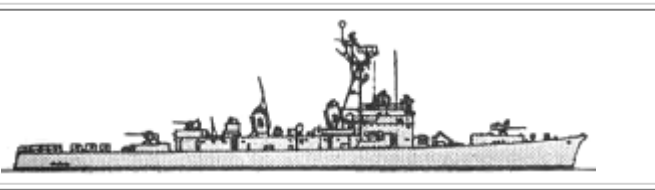
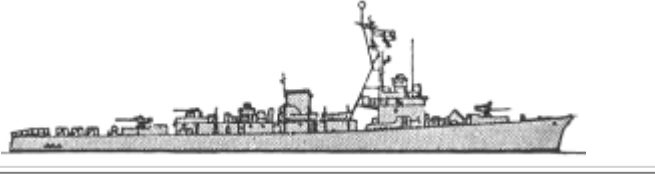
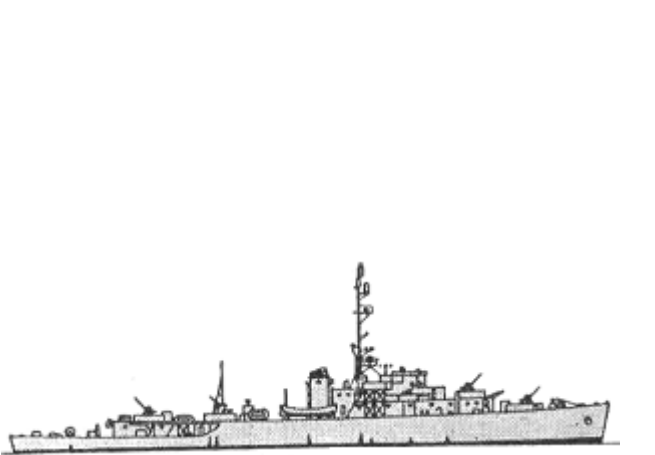

PRINCIPAL SURFACE COMBATANTS

DD	Gleaves	2	DD181	Asakaze	1941		2600t, 106.2x11.0x4.9m, 4b,2gst, 50000hp, 35kts, 208p; 4x1-127/38, 2x4-40/60, 2x1-20/70, 4dct, 2dcr; SC, SG, SPG-4 radars, sonar
			DD182	Hatakaze	1942		
	Fletcher	2	DD183	Ariake	1944		2900t, 114.7x12.1x4.2m, 4b,2gst, 60000hp, 38kts, 273p; 4x1-127/38, 5x2-40/60, 6dct, 2dcr; SC, SG, SPG-12/22 radars, sonar
			DD184	Yugure	1944		
	Harukaze	2	DD101	Harukaze	1956		2340t, 106.3x10.5x3.7m, 2b, 2gst, 30000hp, 30kts, 240p; 3x1-127/38, 2x4-40/60, 2-483TT, 2x24-178 Hedgehog ASWRL, 8dct, 1dcr; SPS-5, SPS-6, SPG-26, SPG-34 radars, SQS-29 sonar
			DD102	Yukikaze	1956		
	Ayanami	4	DD103	Ayanami	1958		2500t, 114.0x10.7x3.7m, 2b,2gst, 35000hp, 32kts, 220p; 3x2-76/50, 1x4-533TT, 2-483TT, 2x24-178 Hedgehog ASWRL, 2dct; OPS-1, OPS-2, SPG-34 radars, OQS-12 sonar
			DD104	Isonami	1958		
			DD105	Uranami	1958		
			DD106	Shikinami	1958		
	Murasame	3	DD107	Murasame	1959		2400t, 114.9x11.0x4.2m, 2b,2gst, 35000hp, 32kts, 220p; 3x1-127/54, 2x2-76/50, 2-483TT, 1x24-178 Hedgehog ASWRL, 2dct, 1dcr; OPS-1, OPS-15, SPG-34, SPG-35 radars, SQS-29 sonar, BLR-1 ECM
			DD108	Yudachi	1959		
DD109			Harusame	1959			





FF	Tachibana	1	DE261	Wakaba	1945		1640t, 100.0x9.4x3.4m, 2b,2gst, 14000hp, 27kts, 206p; 1x2-76/50, 1x24-178 Hedgehog ASWRL, 6dct, 2dcr; SPS-5B, SPS-12, SPG-34 radars
	Cannon	2	DE262	Asahi	1943		1602t, 93.3x11.2x3.2m, 4dg,2em, 6000hp, 21kts, 186p; 3x1-76/50, 3x2-40/60, 8x1-20/70, 1x24-178 Hedgehog ASWRL, 8dct, 2dcr; SA, SF radars, sonar
			DE263	Hatsuhi	1943		
	Akebono	1	DE201	Akebono	1956		1350t, 91.8x8.5x3.4m, 2b,2gst, 18000hp, 28kts, 193p; 2x1-76/50, 1x2-40/60, 1x24-178 Hedgehog ASWRL, 4dct; OPS-2, OPS-3, SPG-34 radars, QHBa, QDA sonars
	Ikazuchi	2	DE202	Ikazuchi	1956		1300t, 88.0x8.7x3.1m, 2d, 12000hp, 25kts, 160p; 2x1-76/50, 1x2-40/60, 1x24-178 Hedgehog ASWRL, 4dct; OPS-2, OPS-3, SPG-34 radars, QHBa, QDA sonars
			DE203	Inazuma	1956		
	Tacoma	18	PF281	Kusu	1943		2238t, 92.6x11.4x3.9m, 3b,2vte, 5500hp, 20kts, 190p; 3x1-76/50, 2x2-40/60, 9x1-20/70, 1x24-178 Hedgehog ASWRL, 8dct, 2dcr; SA, SF, SPG-26 radars, sonar
			PF282	Nara	1944		
			PF283	Kashi	1944		
			PF284	Momi	1944		
PF285			Sugi	1943			
PF286			Matsu	1944			
PF287			Nire	1944			
PF288			Kaya	1943			
PF289			Ume	1944			
PF290			Sakura	1944			
PF291			Kiri	1944			
PF292			Tsuge	1943			
PF293			Kaede	1944			
PF294			Buna	1945			
PF295			Keyaki	1944			
PF296			Tochi	1943			
PF297			Shii	1943			
PF298			Maki	1944			

PATROL AND COASTAL COMBATANTS



		PC301	Kari	1957	
		PC302	Kiji	1957	





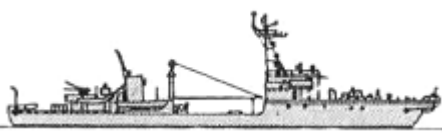

PC	Kari	7	PC303	Taka	1957		340(301-304)-360(305-307)t, 56.0(301-304)-54.0(305-307)x6.5(301-304)-6.6(305-307)x2.1m, 2d, 4000hp, 20kts, 70p; 1x2-40/60, 1x24-178 Hedgehog ASWRL, 2dct(301-304), 2dcr; SPS-5B radar, SQS-11A sonar
			PC304	Washi	1957		
			PC305	Kamome	1957		
PC306			Tsubame	1957			
PC307			Misago	1957			
	Hayabusa	1	PC308	Hayabusa	1957		410t, 58.0x7.8x2.0m, 2d+1gt, 9000hp, 26kts, 75p; 1x2-40/60, 1x24-178 Hedgehog ASWRL, 2dct, 2dcr; SPS-5B radar, SQS-11A sonar
	Umitaka	1	PC309	Umitaka	1959		500t, 60.5x7.1x2.3m, 2d, 4000hp, 21kts, 80p; 1x2-40/60, 2-483TT, 1x24-178 Hedgehog ASWRL, 2dcr; OPS-16 radar, SQS-11A sonar, OLR-4B ECM
PG	LCSL	21	LSSL405	Fuji	1945		387t, 48.2x7.2x1.7m, 8d(2), 2320hp, 15.5kts, 71p; 1x1-76/50(421), 3x2-40/60(405, 406, 416, 417, 420, 422, 423, 432, 439, 440, 442), (2x2+1x1)-40/60(407, 409, 410, 412-414, 418, 424, 425), 2x2-40/60(421), 4x1-20/70, 10x1-127 Mk7 RL; radar
			LSSL406	Bara	1945		
			LSSL407	Sumire	1944		
			LSSL409	Keshi	1944		
			LSSL410	Ayame	1944		
			LSSL412	Fuyo	1944		
			LSSL413	Nogiku	1944		
			LSSL414	Yamagiku	1944		
			LSSL416	Isogiku	1945		
			LSSL417	Shiragiku	1945		
			LSSL418	Iwagiku	1944		
			LSSL420	Kaido	1945		
			LSSL421	Rindo	1944		
			LSSL422	Tsutsuji	1945		
			LSSL423	Himawari	1945		
			LSSL424	Hiiragi	1944		
			LSSL425	Ajisai	1944		
			LSSL432	Suiren	1945		
LSSL439	Hamayu	1945					
LSSL440	Shobu	1945					
LSSL442	Botan	1944					
PT	PT1	6	PT801-806	1-go-6-go	1956		97(801,802)-92(803,804)-98(805,806)t, 25.0(801,802,805,806)-26.0(803,804)x6.5(801,802,805,806)-6.8(803,804)x1.2(801,802,805,806)-1.1(803,804)m, 2d, 4000hp, 30(801,802,805,806)-31(803,804)kts, 18p; 1x1-40/60, 2-533TT, 2x4-178 Mousetrap ASWRL; OPS-4C radar, OQS-1 sonar
	PT7	2	PT807	7-go	1957		135t, 34.0x7.5x1.2m, 3d, 6000hp, 33kts, 27p; 2x1-40/60, 4-533TT, 2x4-178 Mousetrap ASWRL; OPS-4C radar, OQS-1 sonar
			PT808	8-go	1958		
	PT9	1	PT809	9-go	1957		64t, 21.7x6.2x1.8m, 2d, 5000hp, 40kts, 15p; 1x1-40/60, 2-533TT; radar
PB	PB1	15	PB901-907, 911-918	1-go-7-go, 11-go-18-go	1943-1945	No picture	20t, 14.0x4.2x0.9m, 2d, 450hp, 16kts, 6p; 1x1-20/70, 1dcr

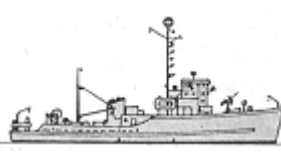
AMPHIBIOUS

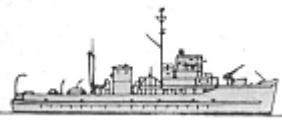

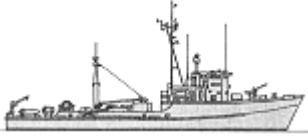

LSM	LSM1	1	LSM3001	Yorikutei	1944		1095t, 62.0x10.5x2.1m, 2d, 2800hp, 13kts, 60p; 1x2-40/60, 4x1-20/70; 5tanks, 54troops; radar
LSS	LCU1466	6	LCU2001		1955		347t, 35.1x10.4x1.6m, 3d, 675hp, 8kts, 14p; 2x1-20/70; 4tanks (167t)
			LCU2002		1955		
			LCU2003		1955		
			LCU2004		1955		
			LCU2005		1955		
			LCU2006		1955		
LC	LCM	29	LCM1001-1029		1954-1955		56t, 17.1x4.3x1.2m, 2d, 450hp, 9kts, 5p; 2x1-12.7; 1tank (31t)
	LCVP	45	1-45		1954		13t, 11.2x3.2x0.9m, 2d, 220hp, 8kts, 3p; 2x1-12.7; 36troops (4t)





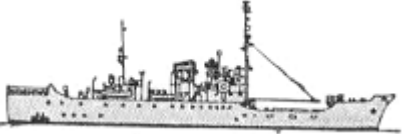
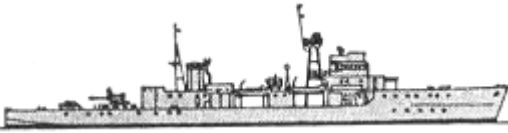
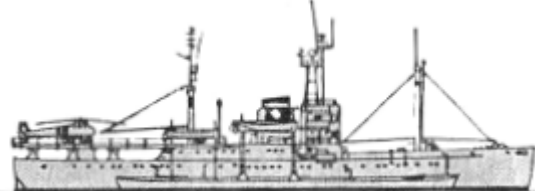

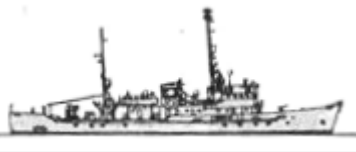

MINE WARFARE

ML	Erimo	1	AMC461	Erimo	1955		700t, 65.5x7.9x2.6m, 2d, 2500hp, 18kts, 87p; 1x2-40/60, 2x1-20/70, 1x24-178 Hedgehog ASWRL, 4dct, 2dcr, mines, minesweeping gear; SPS-5 radar, QHBa sonar
	Tsugaru	1	ARC481	Tsugaru	1955		1400t, 72.0x10.4x3.4m, 2d, 3200hp, 18kts, 100p; 1x1-76/50, 2x1-20/70, 4dct, 2dcr, 40mines; SPS-5 radar, QHBa sonar
MSC	Pa1	10	MS18	Ukishima	1945		285t, 29.8x6.1x2.5m, 1d, 400hp, 9kts; 1x1-40/60, 6x1-25/60, minesweeping gear; 13-go radar
			MS19	Tsurushima	1945		
			MS20	Otoshima	1945		
			MS21	Matsushima	1945		
			MS22	Himeshima	1945		
			MS23	Awashima	1945		
			MS24	Karushima	1945		
			MS25	Kamoshima	1945		
			MS26	Takashima	1945		
			MS29	Oshima	1945		
	Bluebird	4	MSC651	Yashima	1954		400t, 44.3x8.1x2.1m, 2d, 880hp, 12.5kts, 39p; 1x2-20/70, mechanical, acoustic, magnetic minesweeping gear; SPS-53 radar, UQS-1 sonar
			MSC652	Hashima	1954		
			MSC653	Tsushima	1956		
			MSC654	Toshima	1957		
			MSC655	Ujishima	1943		
			MSC656	Etajima	1943		
			MSC657	Nuwajima	1943		

MSI	YMS	9	MSC658	Yakushima	1944		320t, 41.5x7.5x2.4m, 2d, 800hp, 14kts, 60p; 1x1-76/50, 2x1-20/70, 2dct, 2dcr, mechanical, acoustic, magnetic minesweeping gear; radar
			MSC659	Ogishima	1945		
			MSC660	Yugeshima	1944		
			MSC661	Yurishima	1944		
			MSC662	Ninoshima	1943		
			MSC663	Moroshima	1944		
	Atada	2	MSC601	Atada	1956		260t, 37.5x6.8x2.1m, 2d, 1200hp, 14kts, 33p; 1x1-20/70, mechanical, magnetic, acoustic minesweeping gear; SPS-10 radar, UQS-1D sonar
			MSC602	Itsuki	1956		
	Yashiro	1	MSC603	Yashiro	1956		235t, 37.5x7.8x1.9m, 2d, 1200hp, 13.5kts, 33p; 1x1-20/70, mechanical, magnetic, acoustic minesweeping gear; SPS-10 radar, UQS-1D sonar
	Kasado	5	MSC604	Kasado	1958		360t, 45.5x8.4x2.3m, 2d, 1200hp, 14kts, 39p; 1x1-20/70, mechanical, magnetic, acoustic minesweeping gear; OPS-3(604,605), OPS-4D(606-608) radar, UQS-1D(604,605), ZQS-1(606-608) sonar
			MSC605	Shisaka	1958		
			MSC606	Kanawa	1959		
			MSC607	Sakito	1959		
			MSC608	Habushi	1959		
	Cha1	16	MSI690	Yoshikiri	1944		135t, 29.2x5.7x2.0m, 1d, 400hp, 11kts, 32p; 1x1-13.2, minesweeping gear
MSI691			Kamazuru	1944			
MSI692			Yukari	1944			
MSI693			Tomozuru	1944			
MSI694			Shiratori	1944			
MSI695			Chiyozuru	1944			
MSI696			Hatsutaka	1944			
MSI697			Umitsubame	1943			
MSI698			Iwatsubame	1944			
MSI699			Hayatori	1944			
MSI700			Hayodori	1944			
MS04			Furutaka	1944			
MS09			Hayataka	1943			
MS82			Otori	1943			
MS83	Wakataka	1944					
MS84	Shirasagi	1944					
200t ARV	1	MS62	Yuchidori	1939		189t, 38.5x5.9x1.9m, 2d, 800hp, 14kts; 1x1-13.2, minesweeping gear	
200t ARV	1	MS68	Okichidori	1939		189t, 38.5x5.9x1.9m, 2d, 800hp, 14kts; 1x1-25/60, minesweeping gear	
MSB	MSB1	6	MSB701-706	1-go-6-go	1957-1959		45t, 18.6x5.0x1.3m, 2d, 320hp, 11kts, 10p; mechanical or acoustic minesweeping gear
MDV	-	1	MS32	Soei	1944		4300dwt, 99.1x13.8x6.1m, 2b,1gst, 1100hp, 11.5kts

MARITIME SAFETY AGENCY

PSO	Muroto	2	PL02	Daio	1950		842t, 61.0x9.3x3.1m, 2d, 1500hp, 15.8kts, 59p; 1x1-76/50, 2x1-20/70; radar	
			PL03	Muroto	1950			
	Ukuru	5	PL102	Okija	1944		1020t, 78.8x9.1x3.1m, 2d, 4200hp, 19.5kts, 150p; 1x1-76/50, 2x1-20/70; 22-go, 13-go radars	
			PL103	Atsumi	1944			
			PL104	Satsuma	1944			
			PL105	Tsugaru	1944			
			PL106	Kojima	1945			
	Soya	1	PL107	Soya	1938		4818t, 79.1x15.8x5.8m, 2d(1), 4800hp, 12.5kts, 96p; 4 helicopters	
	PS	Awaji	3	PM01	Awaji	1950		549t, 51.0x8.1x2.8m, 2d, 1300hp, 14.9kts, 40p; 1x1-76/50, 1x1-20/70; radar
				PM02	Miyake	1950		
PM03				Sado	1950			
Rebun		14	PM04	Rebun	1951		495t, 52.4x8.1x2.6m, 2d, 1300hp, 14.6kts, 40p; 1x1-76/50, 1x1-20/70; radar	
			PM05	Iki	1951			
			PM06	Oki	1951			
			PM07	Genkai	1951			
			PM08	Hachijo	1951			
			PM09	Amakusa	1951			
			PM10	Okushiri	1951			
			PM11	Kusakaki	1951			
			PM12	Rishiri	1951			
			PM13	Noto	1951			
			PM14	Hekura	1951			
			PM15	Mikura	1951			
			PM16	Koshiki	1951			
			PM17	Hirado	1951			
Chifuri		5	PM18	Chifuri	1952		490t, 55.7x7.7x2.6m, 2d, 1300hp, 15.4kts, 45p; 1x1-76/50, 1x1-20/70; radar	
			PM19	Kurokami	1952			
	PM20		Kozu	1951				
	PM21		Shikine	1952				
	PM22		Daito	1952				
			PS01	Kuma	1951			
			PS02	Fuji	1951			

PC	Kuma	20	PS03	Tenryu	1951		267t, 40.5x7.0x2.2m, 2d, 800hp, 13.6kts, 31p; 1x1-40/60																																																																				
			PS04	Isuzu	1951																																																																						
			PS05	Ishikari	1951																																																																						
			PS06	Sagami	1951																																																																						
			PS07	Oyodo	1951																																																																						
			PS08	Abukuma	1951																																																																						
			PS09	Kuzuryu	1951																																																																						
			PS10	Kikuchi	1951																																																																						
			PS11	Mogami	1951																																																																						
			PS12	Yoshino	1951																																																																						
			PS13	Noshiro	1951																																																																						
			PS14	Kiso	1951																																																																						
			PS15	Shinano	1951																																																																						
			PS16	Chikugo	1952																																																																						
			PS17	Kumano	1952																																																																						
			PS18	Nagara	1952																																																																						
			PS19	Tone	1952																																																																						
			PS20	Kitakami	1952																																																																						
				Tokachi	2			PS51	Tokachi	1954		381t, 51.8x6.6x2.2m, 2d, 1500hp, 16kts, 41p; 1x1-40/60																																																															
								PS52	Tatsuta	1954				Teshio	1	PS53	Teshio	1955		421t, 50.3x7.0x2.5m, 2d, 1400hp, 15.7kts, 41p; 1x1-40/60		Yahagi	4	PS54	Yahagi	1956		377t, 50.3x7.3x2.2m, 2d, 1400hp, 15.5kts, 44p; 1x1-20/70; radar	PS55	Sumida	1957	PS56	Chitose	1958	PS57	Sorachi	1959		300t ARV	8	PS101	Kawachidori	1946		296t, 45.1x6.8x2.3m, 2d, 800hp, 14kts; 1x1-25/60	PS102	Hamachidori	1941	PS103	Asachidori	1940	PS104	Miochidori	1944	PS107	Sawachidori	1944	PS108	Wakachidori	1944	PS109	Murachidori	1942	PS115	Haruchidori	1943		200t ARV	1	PS105	Tomachidori	1940		189t, 38.5x5.9x1.9m, 2d, 800hp, 14kts; 1x1-25/60	
	Teshio	1	PS53	Teshio	1955		421t, 50.3x7.0x2.5m, 2d, 1400hp, 15.7kts, 41p; 1x1-40/60																																																																				
	Yahagi	4	PS54	Yahagi	1956		377t, 50.3x7.3x2.2m, 2d, 1400hp, 15.5kts, 44p; 1x1-20/70; radar																																																																				
PS55			Sumida	1957																																																																							
PS56			Chitose	1958																																																																							
PS57			Sorachi	1959																																																																							
	300t ARV	8	PS101	Kawachidori	1946		296t, 45.1x6.8x2.3m, 2d, 800hp, 14kts; 1x1-25/60																																																																				
PS102			Hamachidori	1941																																																																							
PS103			Asachidori	1940																																																																							
PS104			Miochidori	1944																																																																							
PS107			Sawachidori	1944																																																																							
PS108			Wakachidori	1944																																																																							
PS109			Murachidori	1942																																																																							
PS115	Haruchidori	1943																																																																									
	200t ARV	1	PS105	Tomachidori	1940		189t, 38.5x5.9x1.9m, 2d, 800hp, 14kts; 1x1-25/60																																																																				
	150t(1934)	1	PS111	Isochidori	1934		141t, 37.8x5.2x1.7m, 2d, 520hp, 13kts; 1x1-25/60																																																																				

PB			PC20	Yamazuki	1951			
			PC21	Haruzuki	1951			
			PC22	Natsuzuki	1951			
			PC23	Akizuki	1951			
			PC24	Fuyuzuki	1951			
		Mutsuki	1	PC25	Mutsuki	1951	No picture	69t, 25.5x4.9x2.8m, 2d, 1000hp, 14.9kts, 10p; 1x1-12.7
		Sagiri	4	PC26	Sagiri	1952	No picture	49t, 20.2x4.3x1.0m, 1d, 120hp, 9.7kts, 8p; 1x1-12.7
				PC27	Yugiri	1952		
				PC28	Yamagiri	1952		
				PC29	Kawagiri	1952		
		Shinonome	7	PC30	Shinonome	1954	No picture	46(30)-49(31-36)t, 21.0x5.3x1.3m, 2d, 1000(30)-1400(31-36)hp, 18.9(30)-22.5(31-36)kts, 10p; 1x1-12.7
				PC31	Hatagumo	1954		
				PC32	Makigumo	1954		
				PC33	Yaegumo	1954		
				PC34	Asagumo	1955		
				PC35	Natsugumo	1955		
			PC36	Tatsugumo	1955			
	Hanayuki	2	PC37	Hanayuki	1959	No picture	62(37)-64(38)t, 22.0x5.6x1.0m, 3d(37)-2d(38), 1500(37)-1800(38)hp, 20.7(37)-21.3(38)kts, 9(37)-13(38)p; 1x1-12.7	
			PC38	Mineyuki	1959			
	Harusame	2	CL01	Harusame	1952	No picture	44t, 17.3x4.1x0.9m, 1pe, 115hp, 9.3kts, 6p	
			CL02	Murasame	1952			
	Soyokaze	11	CL03	Soyokaze	1949	No picture	22t, 15.0x4.2x0.6m, 2d, 330hp, 15.8kts, 6p	
			CL04	Sawakaze	1949			
			CL05	Okikaze	1949			
			CL06	Yamakaze	1949			
			CL07	Minekaze	1949			
			CL08	Umikaze	1949			
			CL09	Nokaze	1949			
			CL10	Numakaze	1949			
			CL11	Kawakaze	1949			
			CL12	Tanikaze	1949			
			CL13	Hatsukaze	1949			
	Arakaze	1	CL14	Arakaze	1954	No picture	28t, 15.0x4.2x0.9m, 2d, 440hp, 20.6kts, 6p	
	Harukaze	2	CL15	Harukaze	1958	No picture	25t, 15.0x4.2x0.7m, 2d, 330hp, 16.5kts, 6p; radar	
			CL16	Sachikaze	1958			







[home](#)[World navies yesterday](#)[1960](#)

North Korea 01 January 1960

PRINCIPAL SURFACE COMBATANTS

FS	pr. 53	2	1	1938		503t, 62.0x7.2x2.3m, 2d, 2800hp, 17.8kts, 44p; 1x1-100/56, 3x1-37/73, 4x1-12.7, 2dcr, mechanical minesweeping gear
			2	1938		

PATROL AND COASTAL COMBATANTS

PT	G-5	2	1, 2	1933-1944		20t, 19.1x3.4x1.0m, 2pe, 2000hp, 51kts, 7p; 2x1-12.7, 2-533TT
	pr. 123K	15	1-15	1951-1955		23t, 19.3x3.4x0.8m, 2d, 2000hp, 50kts, 7p; 1x2-14.5, 2-450TT, 2dcr; Zarnitsa radar
	pr. 183	9	1-9	1949-1959		67t, 25.5x6.2x1.2m, 4d, 4800hp, 43kts, 14p; 2x2-25/80, 2-533TT, 2dcr; Reya radar
	Sin Hung	38	1-38	1955-1959		25t, 19.8x3.4x1.7m, 2d, 2400hp, 40kts, 20p; 2x2-14.5, 2-450TT, Zarnitsa radar
	Iwon	15	1-15	1956-1959		40t, 19.2x3.7x1.5m, 3d, 3600hp, 45kts; 2x2-25/80, 2-533TT; Zarnitsa radar
PC	pr. 201	4	1	1958		216t, 41.7x6.2x1.9m, 3d, 6600hp, 27kts, 27p; 2x2-25/80, 4x5 RBU-1200 Uragan ASWRL, 2dcr, 18mines; Reya radar, Tamir-11 sonar
			2	1958		
			3	1959		
			4	1959		
	K48	4	1	1958		110t, 38.1x5.5x1.5m, 2d, 5000hp, 24kts; 1x1-76/55, 3x1-37/73, 3x2-14.5; Reya radar
			2	1958		
			3	1959		
			4	1959		
PB	MO-4	15	1-15	1937-1945		57t, 26.9x4.0x1.5m, 2pe, 2000hp, 24kts, 21p; 1x1-37/73, 1x2-14.5, 2dcr
	KM-4	10	1-10	1957-1959		10t, 14.0x3.2x0.9m, 2pe, 146hp, 10kts, 10p; 1x1-37/73, 1x1-14.5

© Ivan Gogin, 2016



[home](#)[World navies yesterday](#)[1960](#)

South Korea 01 January 1960

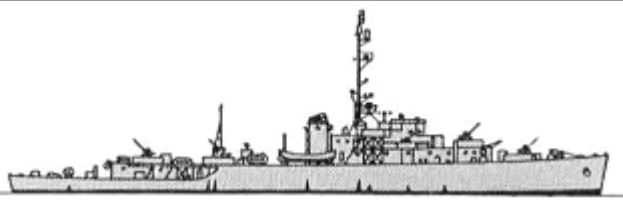
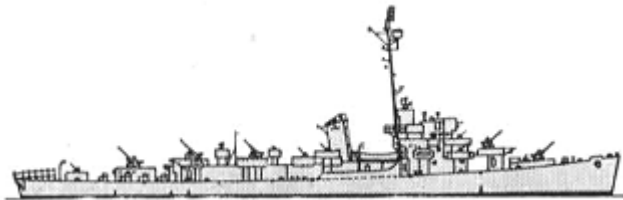
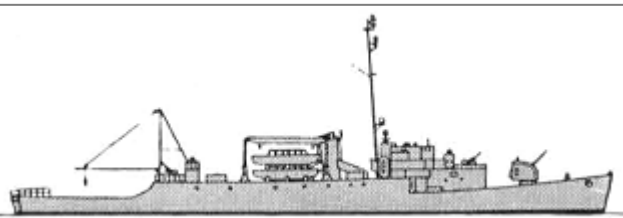
PRINCIPAL SURFACE COMBATANTS





Tacoma	4	61	Dumangang	1944		2238t, 92.6x11.4x3.9m, 3b,2vte, 5500hp, 20kts, 190p; 3x1-76/50, 2x2-40/60, 9x1-20/70, 1x24-178 Hedgehog ASWRL, 8dct, 2dcr; SA, SF, Mk 26 radars, sonar
		63	Daedonggang	1943		
		65	Nagdonggang	1944		
		66	Imjingang	1944		
FF Cannon	2	71	Gyeonggi	1944		1602t, 93.3x11.2x3.2m, 4dg,2em, 6000hp, 21kts, 210p; 3x1-76/50, 3x2-40/60, 10x1-20/70, 1x24-178 Hedgehog ASWRL, 8dct, 2dcr; SA, SF radars, sonar
		72	Gangwon	1944		
APD	1	81	Gyeongnam	1945		2130t, 93.3x11.3x3.8m, 2b,2stg, 2em, 12000hp, 23.6kts, 203p; 1x1-127/38, 3x2-40/60, 6x1-20/70, 2dcr; 4 LCVP, 162troops; SA, SF radars, sonar

PATROL AND COASTAL COMBATANTS

PS	PCE	4	51	Noryang	1945		903t, 56.2x10.1x2.9m, 2d, 2000hp, 15.1kts, 96p; 1x1-76/50, 3x2-40/60, 4x2-20/70, 1x24-178 Hedgehog ASWRL, 4dct, 2dcr; SF radar, sonar
			52	Myengnyang	1944		
			53	Hansan	1943		
			55	Okpo	1945		
PT	ELCO80	3	23	Galamegi	1945		61t, 24.4x6.3x1.6m, 3pe, 4500hp, 43kts, 17p; 1x1-37/71, 1x1-20/70, 2x2-12.7, 2x1-127RL, 4-572TR; SO radar
			25	Gireogi	1945		
			27	Jebi	1945		
PC	173ft	5	701	Baekdusan	1944		450t, 52.9x7.1x3.3m, 2d, 2880hp, 20kts, 70p; 1x1-76/50, 1x1-40/60, 4x1-20/70, 2x4-178 Mousetrap ASWRL, 2dct, 2dcr; radar, sonar
			702	Geumgangsan	1944		
			703	Samgaksan	1945		
			705	Hanlasan	1942		

PC		706	Myohyangsan	1942		
PCS	4	201	Suseong	1944		278t, 41.5x7.5x2.4m, 2d, 800hp, 14kts, 57p; 1x1-76/50, 1x1-40/60, 2x1-20/70, 2x4-178 Mousetrap ASWRL, 4dct, 2dcr; radar, sonar
		202	Geumseong	1944		
		203	Mokseong	1944		
		205	Hwaseong	1944		

AMPHIBIOUS

LST	LST(2)	9	807	Unbong	1944		4080t, 100.0x15.2x4.3m, 2d, 1800hp, 10kts, 70p; (2x2+4x1)-40/60, 2x1-20/70; 4 LCVP, 20tanks, 163troops; 2 radars
			808	Deokbong	1943		
			809	Bibong	1943		
			810	Gyebong	1943		
			811	Jangsu	1943		
			812	Wibong	1945		
			813	Suyeong	1944		
			815	Bukhan	1945		
			816	Hwasan	1945		
LSM	LSM1	12	601	Daecho	1946		1095t, 62.0x10.5x2.1m, 2d, 2800hp, 13kts, 60p; 1x2-40/60, 4x1-20/70; 5tanks, 54troops; radar
			602	Yeodo	1944		
			603	Dokdo	1944		
			605	Gadeok	1944		
			606	Geomun	1944		
			607	Bian	1944		
			608	Pungdo	1944		
			609	Wolmi	1944		
			610	Girin	1944		
			611	Neongna	1944		
			612	Sinmi	1944		
			613	Ulleung	1944		
LSF	LCI(G/M)	1	105	Cheongjin	1944		385t, 48.9x7.2x1.8m, 8d(2), 2320hp, 15.5kts, 53-70p; (1-3)x1-40/60, (0-3)x1-20/70, (0-6)x1-12.7, (8-24)x1 Mk 7 RL or 3x1-107/10mortars; radar
	LCS(L)	4	107	Yeongheungman	1945		387t, 48.2x7.2x1.7m, 8d(2), 2320hp, 15.5kts, 71p; 1x1-76/50(108,109), 3x2-40/60(107), (2x2+1x1)-40/60(110), 4x1-20/70, 10x1-127 Mk 7 RL; radar
			108	Ganghwaman	1945		
			109	Boseongman	1944		
			110	Yeongilman	1944		

MINE WARFARE

		502	Gyeongju	1943		
		503	Gwangju	1944		

MSC	YMS	7	510	Ganggyeong	1943		320t, 41.5x7.5x2.4m, 2d, 800hp, 14kts, 60p; 1x1-76/50, 2x1-20/70, 2dct, 2dcr; mechanical, magnetic, acoustic minesweeping gear; radar
			513	Gimcheon	1944		
			519	Geumhwa	1943		
			520	Gimpo	1944		
			521	Gochang	1944		
	Geumsan	3	522	Geumsan	1959		370t, 43.0x8.0x2.6m, 2d, 1200hp, 14kts, 40p; 1x2-20/70, 3x1-12.7, mechanical, magnetic, acoustic minesweeping gear; Decca 45 radar, UQS1 sonar
			523	Goheung	1959		
525			Geumdok	1959			

© Ivan Gogin, 2016

[home](#)

[World navies yesterday](#)

[1960](#)

Laos 01 January 1960

AMPHIBIOUS

LC	LCM(6)	7	1-7		1943-1945	No picture	56t, 17.1x4.3x1.2m, 2d, 450hp, 9kts, 5p; 2x1-12.7; 1tank
----	--------	---	-----	--	-----------	------------	--

© Ivan Gogin, 2016

[home](#)[World navies yesterday](#)[1960](#)

Lebanon 01 January 1960

PATROL AND COASTAL COMBATANTS

PC	Tarablous	1	31	Tarablous	1959	No picture	105t, 38.0x5.6x1.8m, 2d, 2700hp, 27kts, 19p; 2x1-40/60, 2x1-12.7; radar
PB	Fairmile B	1	41	Djounieh	1943		86t, 34.8x5.6x1.5m, 2pe, 1200hp, 16kts, 16p; 1x1-20/70, 2x1-12.7; radar
	Byblos	3	11	Byblos	1955	No picture	28t, 20.1x4.1x1.2m, 2d, 530hp, 18.5kts; 1x1-20/70, 2x1-12.7; radar
			12	Sidon	1955		
13	Beyrouth	1955					

AMPHIBIOUS

LSS	LCU1466	1		Sour	1953		347t, 35.1x10.4x1.6m, 3d, 675hp, 8kts, 14p; 2x1-20/70; 4tanks or 167t cargo or 300troops; radar
-----	---------	---	--	------	------	--	---

© Ivan Gogin, 2016

[home](#)

[World navies yesterday](#)

[1960](#)

Liberia 01 January 1960

PATROL AND COASTAL COMBATANTS

PB	USCG 40ft	2	2	ML4001, 4002	1945	No picture	12t, 12.3x3.5x1.1m, 2d, 380hp, 23kts
----	-----------	---	---	--------------	------	------------	--------------------------------------

© Ivan Gogin, 2016

[home](#)[World navies yesterday](#)[1960](#)

Malaysia 01 January 1960

PATROL AND COASTAL COMBATANTS

PB	HDML	6	P3502	Sri Trengganu	1943		54t, 22.0x4.8x1.4m, 2d, 300hp, 11.8kts, 10p; 2x1-20/70, 2dcr; type 291 radar
			P3505	Sri Pahang	1944		
			P3506	Sri Negri Sembilan	1944		
			P3507	Sri Perak	1945		
			P3508	Sri Kelantan	1943		
			P3509	Sri Selangor	1943		

AMPHIBIOUS

LSS	LCT(3)	1	MRC1401	Pelandok	1942		640t, 58.1x9.5x2.0m, 2d, 920hp, 10.5kts, 12p; 2x1-20/70; 5tanks
-----	--------	---	---------	----------	------	--	---

MINE WARFARE

MSI	Ham	4	M2602	Sri Johore	1953		159t, 32.5x6.4x1.7m, 2d, 1100hp, 14kts, 15p; 1x1-40/60, minesweeping gear; type 978 radar
			M2604	Sri Perlis	1954		
			M2606	Langka Suka	1953		
			M2612	Nemasek	1953		

© Ivan Gogin, 2016

[home](#)[World navies yesterday](#)[1960](#)

Mexico 01 January 1960

PRINCIPAL SURFACE COMBATANTS

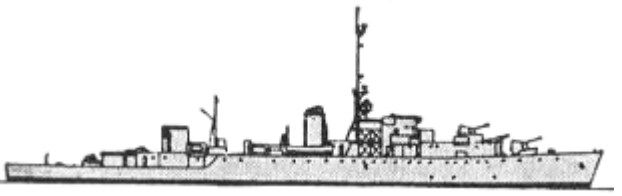
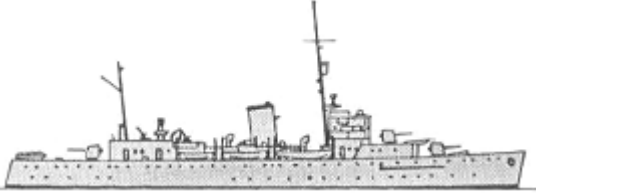
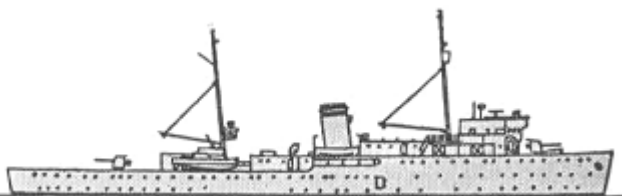
Tacoma	4	1	Usumacinta	1944		2200t, 92.6x11.4x3.9m, 3b,2vte, 5500hp, 19kts, 180p; 2x1-76/50, 2x1-20/70, 6dct, 2dcr; SF, Mk26 radars, sonar
		2	Tehuantepec	1944		
		3	California	1944		
		4	Papaloapan	1944		
FF Guanajuato	3	C7	Guanajuato	1936		1950t, 80.4x11.5x3.1m, 2b,2gst(7,9)-2d(8), 5000hp, 20(7,9)-14(8)kts, 140p; 3x1-102/45(7,9), 1x1-102/45(8), 2x1-20/70, 2x2-13.2, 2dct; 230troops, 40horses; radar
		C8	Querétaro	1936		
		C9	Potosi	1936		
Durango	1	B1	Durango	1936		2000t, 92.4x12.2x3.1m, 2b,2gst, 6500hp, 20kts, 141p; 2x1-102/45, 2x1-57/40, 3x1-20/70, 2x2-13.2, 2dct; 490troops, 80horses; radar

PATROL AND COASTAL COMBATANTS

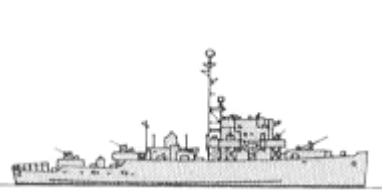
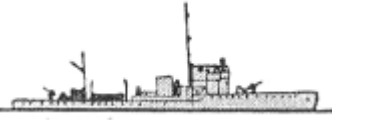
PS PCE	5	1	Pedro Sainz de Baranda	1944		903t, 56.2x10.1x2.9m, 2d, 2000hp, 15.1kts, 96p; 1x1-76/50, 3x2-40/60(1-3,5), 3x1-40/60(4), 4x1-20/70(1,2,5), 5x1-20/70(4), 4dct; radar, sonar
		2	David Porter	1944		
		3	Virgilio Uribe	1943		
		4	Blas Godínez	1943		
		5	Tomás Marín	1944		
PC	1	G28	GC28	1936		180t, 46.6x5.0x1.6m, 2d, 3000hp, 26kts, 21p; 3x1-20/70, 2x2-12.7, 2dct
		G30	GC30	1943		
		G31	GC31	1942		
		G32	GC32	1943		



PC	9	G33	GC33	1945		463t, 52.9x7.1x3.3m, 2d, 2880hp, 19kts, 65p; 1x1-76/50, 1x1-40/60, 5x1-20/70, 2x4-178 Mousetrap ASWRL, 2dct, 2dcr; SO radar, sonar	
		G34	GC34	1944			
		G35	GC35	1944			
		G36	GC36	1945			
		G37	GC37	1943			
		G38	GC38	1944			
PB	Halcon	2	1, 2	Halcon, Nereida	1941-1942	No picture	83t, 25.9x4.3x1.5m, 2d, 800hp, 20kts, 26p

© Ivan Gogin, 2016

[home](#)[World navies yesterday](#)[1960](#)

Netherlands 01 January 1960

SUBMARINES

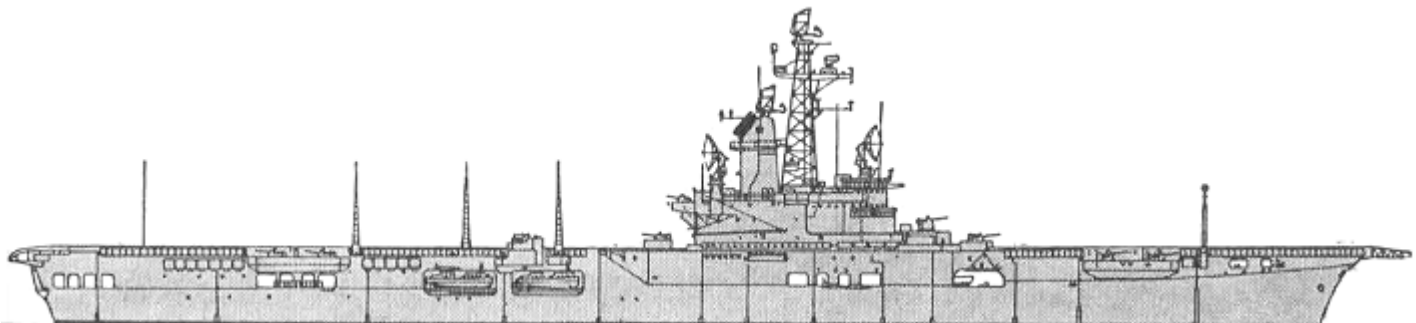

	T batch 3 riveted	1	S814	Zwaardvis	1943		1327/1571t, 83.4x8.1x4.5m, 2d/em, 2500/1450hp, 15.2/9kts, 61p, 95m; 1x1-102/40, 1x1-20/70, 11-533TT; type 267W radar, sonars
SS	T batch 3 welded	1	S812	Tijgerhaai	1945		1319/1571t, 83.4x8.1x4.5m, 2d/em, 2500/1450hp, 15.2/9kts, 61p, 110m; 1x1-102/40, 1x1-20/70, 11-533TT; type 267W radar, sonars
	Balao GUPPY I	2	S802	Walrus	1944		1830/2440t, 93.6x8.2x5.2m, 4dg,4em(2), 4610/5400hp, 18/15kts, 82p, 120m; 10-533TT; SS, SV, BPS-1 radars, BQR-2, BQS-2, SQR-3 sonars
			S803	Zeeleuw	1944		

AIRCRAFT CARRIERS

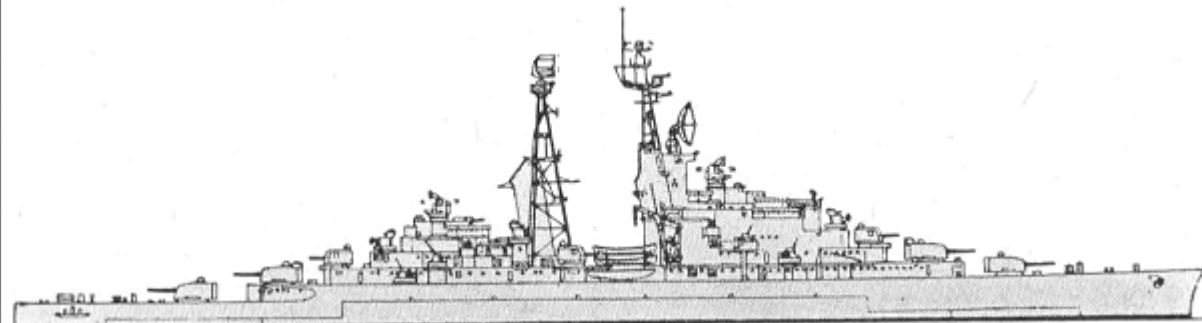

CVL	Colossus	1	R81	Karel Doorman	1945		19896t, 211.2x37.0x7.6m, 4b,2gst, 40000hp, 24kts, 1300p; 12x1-40/70, 21aircraft (Sea Hawk fighters, TBM ASW planes, HSS helicopters); LW-01, LW-02, DA-01, 2x VI-01, ZW-01 radars
-----	----------	---	-----	---------------	------	---	---

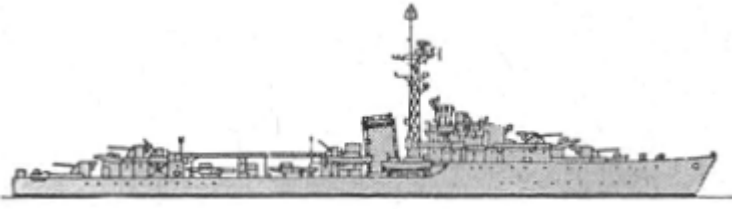
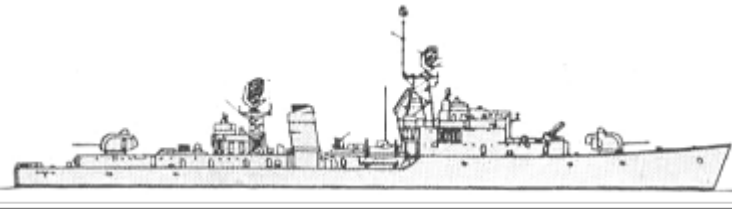
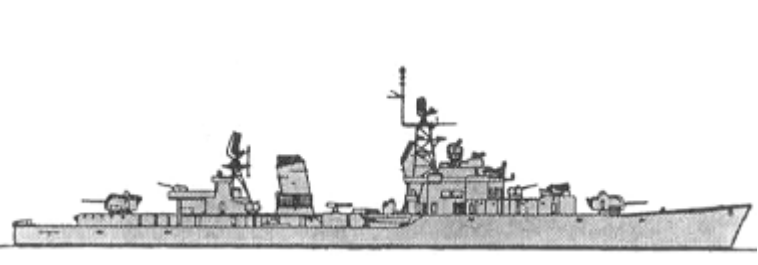
PRINCIPAL SURFACE COMBATANTS

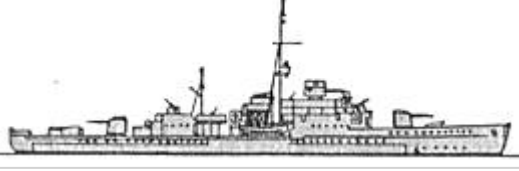
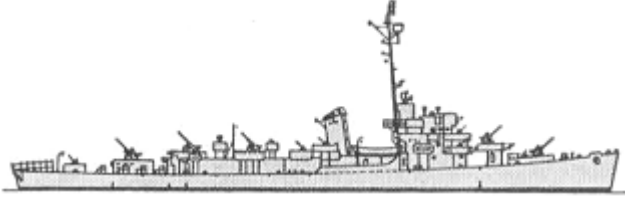
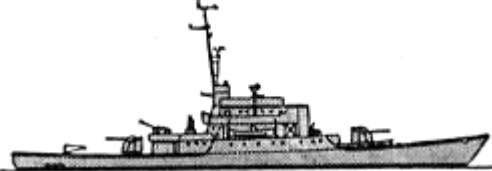



CL	De Ruyter	2	C801	De Ruyter	1953		11850t, 187.3(801)-185.7(802)x17.3x6.7m, 4b,2gst, 85000hp, 32kts, 973p; 75belt, 30deck, 100turrets; 4x2-152/53, 4x2-57/60; LW-01, DA-01, VI-01, ZW-01, 2x M25, 2x M45 radars
			C802	De Zeven Provinciën	1953		
			D802	Evertsen	1943		

S	3	D804	Kortenaer	1943		2545t, 110.6x10.9x4.4m, 2b,2gst, 40000hp, 36.7kts, 225p; 4x1-120/45, 1x2-40/60(802,805), 1x4-40/39(804), 4x2-20/70, 2x4-533TT, 4dct, 2dcr, helodeck; type 275, 277, 282, 291 radars, type 123A, 127 sonars	
		D805	Piet Hein	1943			
Holland	4	D808	Holland	1954		2765t, 113.1x11.4x5.1m, 4b,2gst, 45000hp, 32kts, 247p; 2x2-120/50, 1x1-40/70, 2x4-375 Bofors ASWRL, 2dcr; DA-01, LW-02, ZW-01, M45 radars, type 170B, 162 sonars	
		D809	Zeeland	1955			
		D810	Noord Brabant	1955			
		D811	Gelderland	1955			
Friesland	8	D812	Friesland	1956		3070t, 116.0x11.7x5.2m, 4b,2gst, 60000hp, 36kts, 284p; 2x2-120/50, 6x1-40/70, 2x4-375 Bofors ASWRL, 2dcr; LW-02, DA-01, ZW-01, M45 radars, type 170B, 162 sonars	
		D813	Groningen	1956			
		D814	Limburg	1956			
		D815	Overijssel	1957			
		D816	Drenthe	1957			
		D817	Utrecht	1957			
		D818	Rotterdam	1957			
		D819	Amsterdam	1958			
G	1	F801	Marnix	1936		1900t, 98.5x10.1x3.8m, 3b,2gst, 34000hp, 36kts, 145p; 2x1-105/45, (2x2+2x1)-20/70, 1x24-178 Hedgehog ASWRL, 2dct; type 275, 277, 282, 291 radars, type 121 sonar	
A	1	F805	Van Speijk	1942		1404t, 77.9x10.2x2.9m, 2d, 5250hp, 17.5kts, 161p; 60belt, 35deck, 60turrets, 20CT; 2x2-120/45, 4x1-40/60, 6x1-20/70, 8dct, 80mines	
		F806	Van Amstel	1943		1602t, 93.3x11.2x3.2m, 4dg,2em, 6000hp, 21kts, 186p; 3x1-76/50, 3x2-40/60, 10x1-20/70, 1x24-178 Hedgehog ASWRL, 8dct, 2dcr; SPS-5, SPS-6 radars, sonar	
		F807	De Bitter	1944			
		F808	Van Ewijck	1943			
		F809	Dubois	1943			
		F810	De Zeeuw	1944			
		F811	Van Zijll	1943			
FS	Albatros	1	F823	Lynx	1956		950t, 76.3x9.7x2.8m, 2d, 5200hp, 19kts, 109p; 2x1-76/62, 1x2-40/70, 2x24-178 Hedgehog ASWRL, 2dct; MLN-1A radar, QCU-2 sonar

PATROL AND COASTAL COMBATANTS

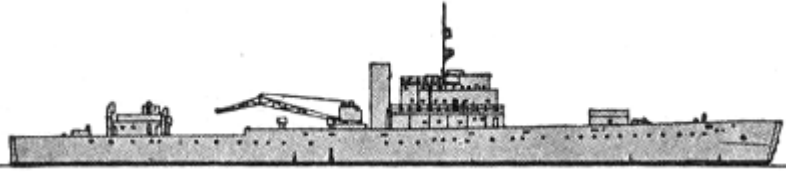

PSO	Roofdier	6	F817	Wolf	1954		975t, 56.2x10.0x2.9m, 2d, 1600hp, 15kts, 96p; 1x1-76/50, 6x1-40/60(817-820), 4x1-40/60(821,822), 8x1-20/70, 1x24-178 Hedgehog ASWRL, 2dct(817-820), 4dct(821,822), 2dcr; QCU-2 sonar
			F818	Fret	1954		
			F819	Hermelijn	1954		
			F820	Vos	1954		
			F821	Panter	1954		
			F822	Jaguar	1954		
PC	PC	1	P801	Queen Wilhelmina	1942		335t, 52.9x7.1x2.4m, 2d, 2880hp, 20kts, 59p; 1x1-40/60, 5x1-20/70, 2x4-178 Hedgehog ASWRL, 2dct, 2dcr; sonar
			Balder	5	P802		
	P803	Bulgia			1954		
	P804	Freyr			1954		
	P805	Hadda			1955		
	P806	Hefring	1955		225t, 36.3x6.2x1.9m, 2d, 1050hp, 15.5kts, 28p; 1x1-40/60, 3x1-20/70, 2x4-178 Mousetrap ASWRL, 2dct, 2dcr; sonar		



AMPHIBIOUS

LST	LST(1)	1	LST2	Pelikaan	1943		5970t, 122.4x15.4x5.6m, 2b,2gst, 7000hp, 16.2kts, 127p; 2x1-40/60, (2x2+5x1)-20/70; 1 LCM/LCS, 13tanks, 27trucks, 193troops
LCU	LCT(4)	6	L9607		1944		640t, 57.1x11.8x1.4m, 2d, 920hp, 10kts, 12p; 2x1-20/70; 6tanks or 200troops
			L9608		1945		
			L9609		1944		
			L9610		1943		
			L9611		1944		
			L9612		1944		
	LCT(3)	3	L9601		1944		640t, 58.1x9.5x1.7m, 2pe, 1000hp, 11.5kts, 12p; 2x1-20/70; 5tanks
			L9602		1944		
			L9606		1945		
LC	LCM(3)	15	L9661,9662, A-O		1942-1944		52t, 15.2x4.3x1.4m, 2d, 220-450hp, 8.5-11kts, 3p; 1x2-12.7; 1tank
	LCA	8	L9505, 9508, 9509, 9510, 9516, 9518-9520		1942-1944		12t, 12.6x3.1x0.7m, 2pe, 130hp, 8kts, 4p; 2x1-51/11; 40troops
	L9531	7	L9531-9537		1955-1956	No picture	55t, 25.3x4.5x1.0m, 1d, 100hp, 10kts, 6p; 2x1-12.7; 15t of cargo
	L9521	6	L9521-9526		1956-1957	No picture	20t, 14.6x3.5x1.5m, 2d, 75hp, 8.5kts, 4p; 4t of cargo

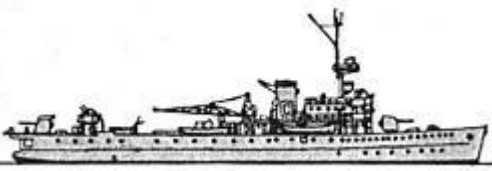
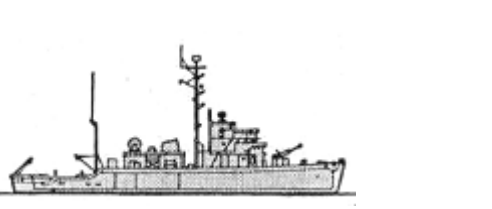
MINE WARFARE

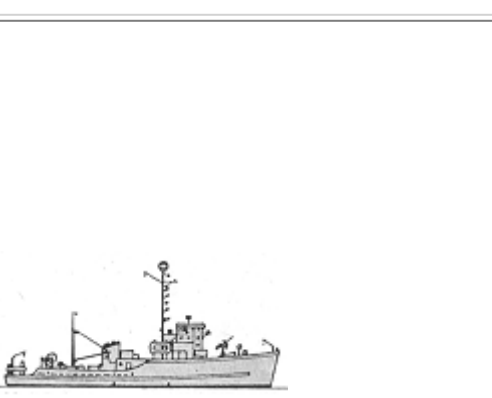
--	--	--	--	--	--	--	--

ML	Willem van der Zaan	1	N82	Willem van der Zaan	1939		1407t, 75.2x11.2x3.3m, 2b,2vte, 2200hp, 15.5kts, 92p; 2x1-120/50, 2x2-40/60, 4x1-20/70, 2dcr, 90mines; sonar
MSO	Agile	6	M884	Onversaagd	1954		735t, 52.3x10.4x4.0m, 4d(2), 2280hp, 14kts, 70p; 1x1-40/60, 2x1-12.7, mechanical, acoustic, magnetic sweeps; SPS-53 radar, UQS-1 sonar
			M885	Onbevreesd	1954		
			M886	Onverschrokken	1954		
			M887	Onvermoeid	1954		
			M888	Onvervaard	1955		
			M889	Onverdroten	1954		
BYMS		5	M831	Borndiep	1943		250t, 41.5x7.5x2.4m, 2d, 800hp, 15kts, 60p; 1x1-76/50, 2x1-20/70, mechanical, acoustic, magnetic sweeps
			M832	Deurloo	1943		
			M834	Marsdiep	1943		
			M837	Vliestroom	1943		
			M840	Zuiderdiep	1943		
Beemster		14	M845	Beemster	1953		400t, 44.3x8.1x2.1m, 2d, 880hp, 12kts, 39p; 1x2-20/70, mechanical, acoustic, magnetic sweeps; SPS-53 radar, UQS-1 sonar
			M846	Bolsward	1953		
			M847	Bedum	1953		
			M848	Beilen	1954		
			M849	Borculo	1953		
			M850	Borne	1953		
			M851	Brummen	1954		
			M852	Breukelen	1954		
			M853	Blaricum	1954		
			M854	Brielle	1953		
			M855	Breskens	1954		
			M856	Bruinisse	1954		
			M857	Boxtel	1954		
			M858	Brouwershaven	1954		
MSC			M801	Dokkum	1955		
			M802	Hoogezand	1956		
			M803	Wildervank	1955		
			M804	Steenwijk	1956		
			M805	Gieten	1956		
			M806	Roermond	1955		
			M807	Waalwijk	1956		
			M808	Axel	1956		
			M809	Naaldwijk	1955		
			M810	Abcoude	1956		
			M811	Aalsmeer	1956		

			M812	Drachten	1956		
			M813	Ommen	1956		
			M814	Meppel	1956		
			M815	Giethorn	1956		
			M816	Lochem	1956		
			M817	Venlo	1956		
			M818	Drunen	1956		
			M819	Goes	1956		
			M820	Woerden	1957		
			M822	Leersum	1957		
			M823	Naarden	1956		
			M824	Sneek	1957		
			M826	Grijpskerk	1956		
			M827	Hoogeveen	1956		
			M828	Staphorst	1957		
			M829	Elst	1956		
			M830	Sittard	1956		
			M841	Gemert	1956		
			M842	Veere	1956		
			M843	Lisse	1957		
			M844	Rhemen	1956		
							
	Dokkum	32					453t, 46.6x8.8x2.3m, 2d, 2500hp, 14kts, 38p; 2x1-40/60, mechanical sweep; TM1229C radar
MSB	HDML	3	Y8128	Keeten	1944		
			Y8129	Mastgat	1945		
			Y8130	Zijpe	1945		54t, 22.0x4.8x1.4m, 2d, 260-480hp, 11-13.5kts, 10p; 2x1-20/70, sweeps; type291 radar, sonar

[home](#)

[World navies yesterday](#)

[1960](#)

Nicaragua 01 January 1960

PATROL AND COASTAL COMBATANTS

PB	GC2	4	GC2-5	-	1947	No picture	27.5m
----	-----	---	-------	---	------	------------	-------

© Ivan Gogin, 2016



[home](#)[World navies yesterday](#)[1960](#)

Nigeria 01 January 1960

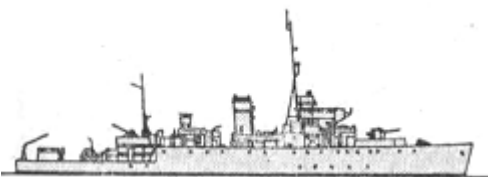
PRINCIPAL SURFACE COMBATANTS

FS	Algerine turbine	1	1	Nigeria	1944		1265t, 68.6x10.8x3.2m, 2b,2gst, 2000hp, 16.5kts, 138p; 1x1-102/45, 4x1-40/60, 4dct, 2dcr; radar, sonar
----	------------------	---	---	---------	------	--	--

PATROL AND COASTAL COMBATANTS

PB	HDML	1	1	Kaduna	1943		54t, 22.0x4.8x1.4m, 2d, 300hp, 11.8kts, 10p; 2x1-20/70, 2dcr; type 291 radar
	Fairmile B	2	1	Calabar	1941		86t, 34.8x5.6x1.5m, 2pe, 1200hp, 18kts, 16p; 1x1-47/40, (1x2+1x1)-20/70, 2dct, 2dcr; type 286 radar, sonar
2			Sapele	1941			

AMPHIBIOUS

LSM	LCT(4)	1	1	LCT1213	1944		640t, 57.1x11.8x1.4m, 2d, 920hp, 10kts, 12p; 2x1-20/70; 6 tanks or 200troops; radar
-----	--------	---	---	---------	------	--	---

© Ivan Gogin, 2016

[home](#)[World navies yesterday](#)[1960](#)

Norway 01 January 1960

SUBMARINES

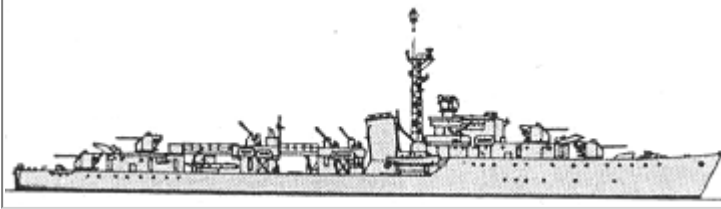
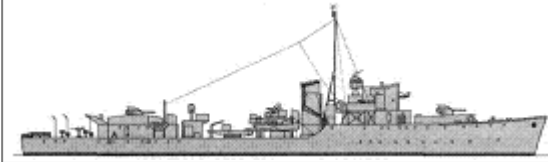
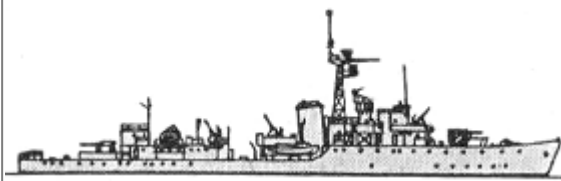

U	1	S300	Ula	1943		630/732t, 60.0x4.9x4.6m, 2dg,2em, 615/825hp, 11.2/10kts, 33p, 60m; 1x1-76/45, 4-533TT; type 291W radar, sonars	
SS	V	4	S301	Utsira	1944		662/740t, 62.3x4.9x4.7m, 2dg,2em, 615/825hp, 11.2/10kts, 33p, 90m; 1x1-76/45, 2x1-20/70, 4-533TT; type 267QW radar, sonars
			S302	Utstein	1943		
			S303	Utvær	1943		
			S304	Uthaug	1944		
VIIC	2	S307	Kya	1944		769/1070t, 67.1x6.2x4.7m, 2d/em, 3200/750hp, 17.7/7.6kts, 56p, 100m; 1x1-37/69, 2x2-20/65, 5-533TT; FuMO65 radar, sonar	
		S308	Kinn	1944			
VIIC/41	1	S309	Kaura	1943		769/1070t, 67.2x6.2x4.8m, 2d/em, 3200/750hp, 17.7/7.6kts, 56p, 120m; 1x1-37/69, 2x2-20/65, 5-533TT; FuMO65 radar, sonar	

PRINCIPAL SURFACE COMBATANTS

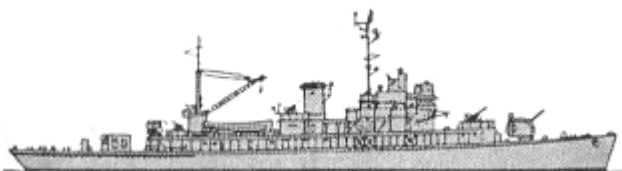
DD	Cr	4	D303	Oslo	1947		2535t, 110.6x10.9x4.4m, 2b,2gst, 40000hp, 36.7kts, 186p; 4x1-114/45, 1x2-40/60, (2x2+2x1)-20/70, 1x4-533TT, 2dct, 2dcr; type 275, 277, 282, 291 radars, type 123, 127 sonars
			D304	Bergen	1946		
			D305	Trondheim	1945		
			D306	Stavanger	1946		
FF	Hunt 3	1	F309	Narvik	1942		1590t, 85.3x9.6x3.7m, 2b,2gst, 19000hp, 27kts, 168p; 2x2-102/45, (1x4+1x1)-40/39, 3x1-20/70, 1x2-533TT, 4dct, 2dcr; type 272, 285, 291 radars, type 123A, 127 sonar
			Hunt 2	3	F310		
	F311	Tromsø			1942		
	F312	Haugesund			1941		
	Canadian River	3	F313	Draug	1944		2360t, 91.8x11.2x4.9m, 2b,2vte, 5500hp, 20kts, 140p; 1x2-102/45, (1x2+4x1)-40/60, 2x3-305 Squid ASWRL, 2dct, 3dcr; type 271, 285, 291 radars, type 123A, 127 sonars
			F314	Troll	1944		
							2360t, 91.8x11.2x4.9m, 2b,2vte, 5500hp, 20kts, 140p; 1x2-102/45, (1x2+4x1)-40/60, 2x3-305 Squid ASWRL; SU, SPQ-2, type 275, 262 radars, type 147, 162, 164B sonars, TDY-1 ECM

			F315	Garm	1944		
FT	Barnegat	1	A537	Haakon VII	1945		2800t, 94.7x12.5x3.8m, 4dg,2em, 6080hp, 20kts, 215+86p; 1x1-127/38, (1x4+2x2)-40/60, 4x1-20/70, 2dct, 2dcr; radars, sonar

PATROL AND COASTAL COMBATANTS

PT	ELCO 80ft	10	P950	Sel	1945		61t, 24.4x6.3x1.6m, 3pe, 4500hp, 43kts, 17p; 1x1-40/60, 1x1-20/70, 2x2-12.7, 2-533TT; radar
			P951	Sild	1945		
			P952	Skrei	1945		
			P953	Lyr	1945		
			P954	Knurr	1945		
			P955	Springer	1945		
			P956	Hai	1945		
			P957	Laks	1945		
			P958	Hval	1945		
			P959	Delfin	1945		
	Rapp	6	P351	Rapp	1952		72t, 26.5x7.0x1.5m, 4pe, 4800hp, 41kts, 18p; 1x1-40/60, 1x1-20/70, 4-533TT; radar
			P352	Rask	1953		
			P353	Kvikk	1954		
			P354	Kjapp	1955		
			P355	Snar	1955		
			P356	Snøgg	1955		
	Nasty	1		Nasty	1958		76t, 24.5x7.5x2.1m, 2d, 5000hp, 43kts, 22p; 2x1-40/60, 4-533TT; radar

AMPHIBIOUS

LCU	LCU1476	1	A30	Tjeldsund	1953		347t, 35.1x10.4x1.6m, 3d, 675hp, 8kts, 14p; 2x1-20/70; 4tanks
-----	---------	---	-----	-----------	------	--	---

MINE WARFARE

Otra	2	N33	Rauma	1940		370t, 52.1x7.1x1.8m, 1b,2vte, 900hp, 13.5kts, 25p; 1x1-40/60, 2x1-20/70, 2x1-12.7, sweeps, mines
		N34	Otra	1939		

ML	LCT(4)	2	N35	Vargsund	1945		640t, 57.1x11.8x1.4m, 2d, 920hp, 10kts, 12p; 2x1-20/70, 80mines
			N36	Reinønsund	1945		
	LSM1	2	N45	Vale	1945		1100t, 61.9x10.5x2.6m, 2d, 2880hp, 12kts, 89p; 3x2-40/60, 5x1-20/70, 400mines; 2 nav. radars
			N46	Vidar	1945		
	Auk	2	N47	Tyr	1942		1250t, 67.4x9.8x3.4m, 2dg,2em, 2070hp, 16kts, 83p; 1x1-76/50, 2x2-20/70, 2x24-178 Hedgehog ASWRL, 3dct, 80mines; radar, sonar
N48			Gor	1942			
MSO	Bangor	2	M309	Glomma	1940		690t, 49.4x8.5x2.8m, 2d, 2000hp, 16.5kts, 60p; 1x1-76/45, 3x1-20/70, 4dct, 2dcr, sweeps; radar, sonar
			M310	Tana	1941		
	Aggressive	2	M950	Lågen	1955		735t, 52.3x10.4x4.0m, 4d(2), 2280hp, 14kts, 70p; 1x1-40/60, 2x1-12.7, sweeps; SPS-53 radar, UQS-1 sonar
M951			Namsen	1955			
MSC	YMS	4	M318	Gaula	1943		320t, 41.5x7.5x2.4m, 2d, 800hp, 14kts, 60p; 1x1-76/50, 2x1-20/70, 2dct, 2dcr, sweeps; radar
			M319	Driva	1943		
			M322	Begna	1943		
			M330	Rana	1943		
	Bluebird	7	M311	Sauda	1953		400t, 44.3x8.1x2.1m, 2d, 880hp, 12kts, 39p; 1x2-20/70, sweeps; Decca RM707 radar, UQS-1 sonar
			M312	Sira	1955		
			M315	Ogna	1955		
			M316	Vosso	1955		
			M331	Tista	1955		
			M332	Kvina	1955		
M334	Utla	1955					

[home](#)[World navies yesterday](#)[1960](#)

Pakistan 01 January 1960

PRINCIPAL SURFACE COMBATANTS

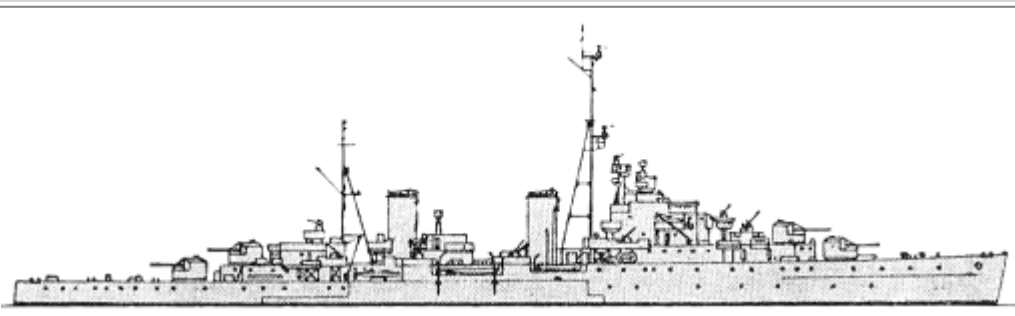
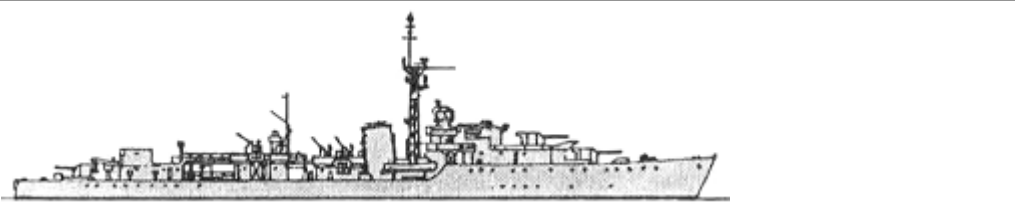
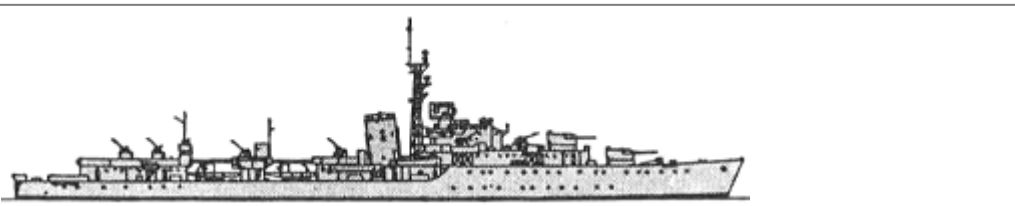
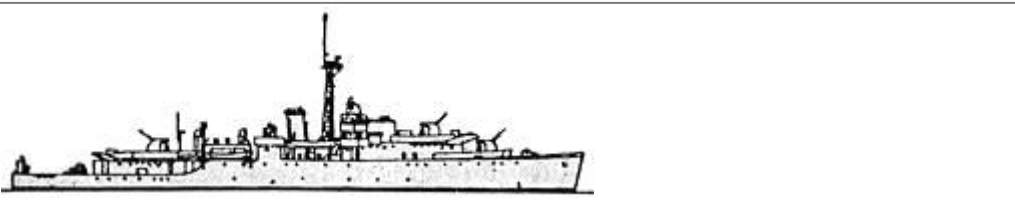
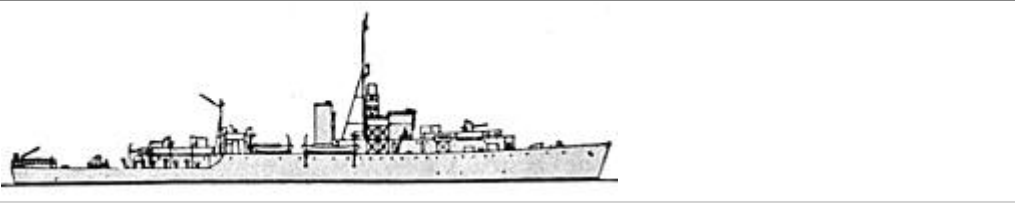
CL	Bellona	1	C84	Babur	1944		7560t, 156.1x15.4x5.6m, 4b,4gst, 62000hp, 30kts, 588p; 76belt, 51deck, 13turrets; 4x2-133/50, (3x2+8x1)-40/60, 2x3-533TT; type 293, 281B, 974, 284, 2x type 285 radars
DD	Ch	4	D21	Taimur	1946		2545t, 110.6x10.9x4.4m, 2b,2gst, 40000hp, 36.7kts, 200p; 3x1-114/45, (1x2+4x1)-40/60, 1x4-533TT, 2x3-305 Squid ASWRL; type 275, 293, Decca radars, type 170, 174 sonars
			D29	Shah Jehan	1945		
			D82	Alamgir	1946		
			D168	Jahangir	1946		
DD	Battle	2	D47	Badr	1946		3361t, 115.5x12.3x4.6m, 2b,2gst, 50000hp, 35.7kts, 222p; 2x2-114/45, (4x2+4x1)-40/60, 2x4-533TT, 1x3-305 Squid ASWRL; type 262, 275, 277, 283, 291, 293 radars, type 123A, 127 sonars
			D79	Khaibar	1946		
FF	Bittern mod.	1	F40	Jhelum	1943		1758t, 89.2x11.4x3.3m, 2b,2gst, 3600hp, 19kts, 195p; 3x2-102/45, (2x2+2x1)-20/70, 4dct, 2dcr; type 272, 285, 291 radars, type 123A, 127 sonars
	River	1	F392	Shamsher	1944		2180t, 91.8x11.2x3.9m, 2b,2vte, 5500hp, 20kts, 140p; 2x1-102/40, (4x2+2x1)-20/70, 1x24-178 Hedgehog ASWRL, 8dct, 2dcr; type 271, 291 radars, sonars
	O	2	D49	Tippu Sultan	1941		2593t, 109.2x10.9x4.9m, 2b,2gst, 40000hp, 36.7kts, 180p; 1x2-102/45, (1x2+3x1)-40/60, 1x4-533TT, 2x3-305 Squid ASWRL; type 293, 974 radars, type

[home](#)[World navies yesterday](#)[1960](#)

Paraguay 01 January 1960

PATROL AND COASTAL COMBATANTS

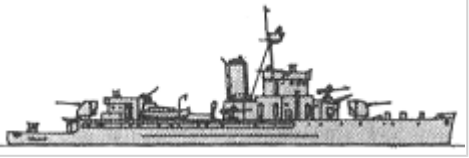
PR	Paraguay	2	C1	Paraguay	1931		835t, 71.2x10.7x2.9m, 2b,2gst, 3800hp, 17kts, 86p; 12belt, 8deck, 10turrets, 19CT; 2x2-120/50, 3x1-76/40, 2x1-40/39, 6mines
			C2	Humaitá	1931		
APR	-	1	P01	Capitán Cabral	1907		206t; 1x1-76/40
PB	USCG 40ft	6	P1-6		1944	No picture	16t, 13.9x4.1x1.1m, 2pe, 190hp, 20kts, 10p; 2x1-20/70

© Ivan Gogin, 2016

[home](#)[World navies yesterday](#)[1960](#)

Peru 01 January 1960



SUBMARINES

SS	Lobo	4	S41	Lobo	1954		815/1400t, 74.1x6.7x4.3m, 2dg,2em, 2400hp, 16/10kts, 40p, 100m; 1x1-127/25(41,42), 6-533TT, SS-2A radar, BQR-3, BQA-1A sonars
			S42	Tiburón	1954		
			S43	Atún	1957		
			S44	Merlín	1957		

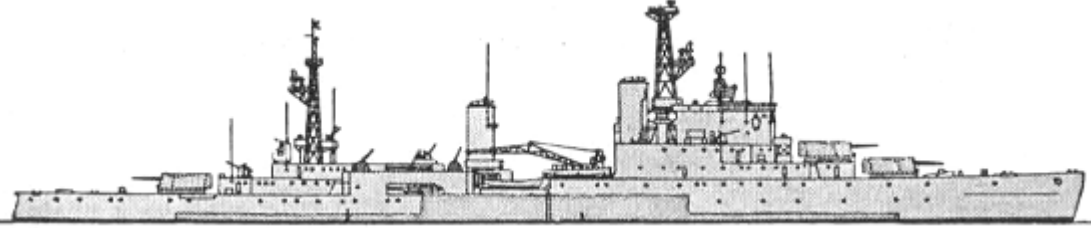
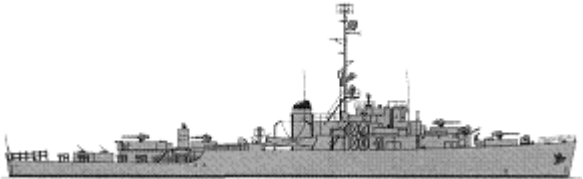
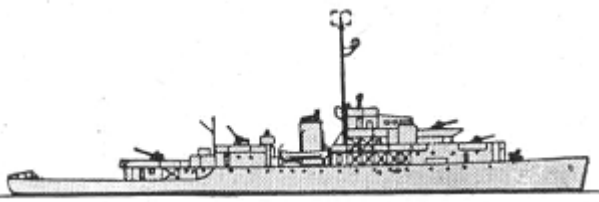
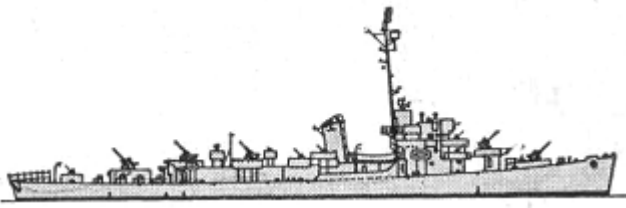
PRINCIPAL SURFACE COMBATANTS

CL	Colony	1	C81	Almirante Grau	1943		11090t, 169.3x18.9x6.3m, 4b,4gst, 72500hp, 31.5kts, 730p; 89belt, 51deck, 51turrets; 3x3-152/50, 4x2-102/45, (5x2+2x1)-40/60; type 960, 274, 277, 293, Mk63 radars
	Tacoma	1	F1	Gálvez	1944		2238t, 92.6x11.4x3.9m, 3b,2vte, 5500hp, 20kts, 190p; 3x1-76/50, 2x2-40/60, 9x1-20/70, 1x24-178 Hedgehog ASWRL, 8dct, 2dcr; SF, Mk26 radars, sonar
FF	Canadian River	2	FE3	Ferré	1944		2180t, 91.8x11.2x3.9m, 2b,2vte, 20kts, 140p; 3x1-76/50, 2x2-40/60, (2x2+1x1)-20/70, 1x24-178 Hedgehog ASWRL, 8dct, 2dcr; radars, sonars
			FE4	Palacios	1944		
	Bostwick	3	DE1	Castilla	1943		1602t, 93.3x11.2x3.2m, 4dg,2em, 6000hp, 21kts, 172p; 3x1-76/50, 3x2-40/60, 10x1-20/70, 1x24-178 Hedgehog, 8dct, 2dcr; SPS-6, SPS-10 radars, sonar
DE2			Aguirre	1943			
DE3			Rodríguez	1943			

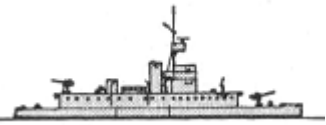
PATROL AND COASTAL COMBATANTS

PR	Iquitos	1	1	Iquitos	1896	No picture	50t, 23.4x3.7x1.2m, 7.5kts; 4x1-37/20, 2x1-20/60
	América	1	1	América	1904	No picture	240t, 40.5x5.9x1.4m, 2b,2vte, 350hp, 14kts, 26p; 2x1-65/50, 3x1-47/40, 2x1-20/60
	Napo	1	1	Napo	1920	No picture	98t, 30.9x5.5x0.9m, 1b,1vte, 250hp, 12kts, 22p; 4x1-47/40, 2x1-20/60
	Amazonas	2	CF11	Amazonas	1935		250t, 46.7x6.7x1.4m, 2d, 750hp, 15.5kts, 35p; 4x1-76/50, 2x1-47/40
			CF12	Loreto	1935		
Ucayali	2	CF13	Ucayali	1951		365t, 47.2x9.8x1.2m, 2d, 800hp, 12kts, 40p; 2x1-76/50, 2x1-40/60, (2x2+3x1)-20/70; radar	
		CF14	Marañon	1951			
PB	CG 83'	4	1-4	CS1-4	1942-1943		45t, 25.3x4.9x1.4m, 2pe, 1200hp, 20.5kts, 10p; 1x1-20/70, 4dcr

AMPHIBIOUS

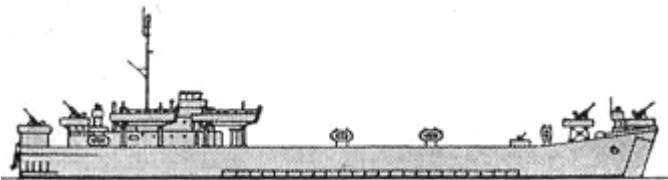
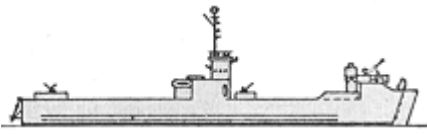



LST	LST(2)	2	34	Chimbote	1943		4080t, 100.0x15.2x4.3m, 2d, 1800hp, 12.1kts, 125p; 1x1-76/50(34), (1x2+4x1)-40/60(35), 6x1-20/70(35); 4 LCVP, 20tanks, 163troops; radar
			35	Paita	1944		
LSM	LSM1	2	36	Lomas	1945		1095t, 62.0x10.5x2.1m, 2d, 2800hp, 13kts, 60p; 1x2-40/60, 4x1-20/70; 5tanks, 54troops
			37	Atico	1945		

© Ivan Gogin, 2016

[home](#)[World navies yesterday](#)[1960](#)

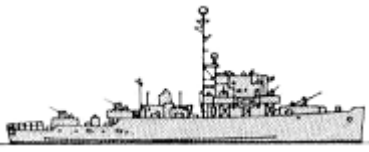
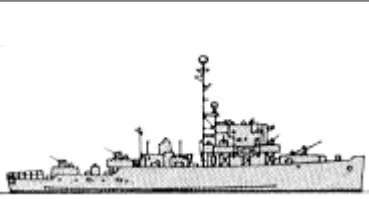
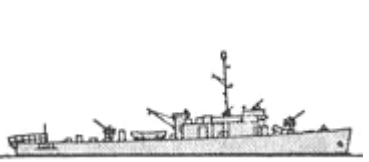

Philippines 01 January 1960

PATROL AND COASTAL COMBATANTS

PS	Admiralty	1	M33	Samar	1944		903t, 56.2x10.1x3.0m, 2d, 2000hp, 15kts, 95p; 1x1-76/50, 2x2-40/60, 4x1-20/70; SO radar
	PCE	5	E28	Cebu	1944		903t, 56.2x10.1x2.9m, 2d, 2000hp, 15.1kts, 85p; 1x1-76/50, 3x2-40/60, 4x1-20/70, 1x24-178 Hedgehog ASWRL, 4dct, 2dcr; SO radar, sonar
			E29	Negros Occidental	1945		
			E30	Leyte	1945		
			E31	Pangasian	1944		
E32	Iloilo	1945					
PC	PC 173ft	5	C22	Bohol	1943		463t, 52.9x7.1x3.3m, 2d, 2880hp, 19kts, 65p; 1x1-76/50, 1x1-40/60, 5x1-20/70, 2x4-178 Mousetrap ASWRL, 2dct, 2dcr; SF radar, QHa sonar
			C24	Batangas	1943		
			C25	Nueva Esija	1943		
			C26	Negros Oriental	1944		
			C27	Capiz	1944		
	PCS	2	P11	Tarlac	1944		278t, 41.5x7.5x2.4m, 2d, 800hp, 14kts, 57p; 1x1-76/50, 1x1-40/60, 4x1-20/70; radar
			P12	Laguna	1944		
	SC	4	P15	Mountain Province	1943		136t, 33.8x5.5x2.0m, 2d, 1000hp, 16kts, 27p; 1x1-40/60, 3x1-20/70, 2x4-178 Mousetrap ASWRL, 2dct, 2dcr; SF radar, QC sonar
			P17	Surigao	1942		
			P19	Cavite	1942		
			P20	Ilocus Norte	1943		
	Camarines Sur	6	G48	Camarines Sur	1954		143t, 33.8x5.5x2.0m, 2d, 1540hp, 18kts, 27p; 2x1-40/60, 2x1-20/70, 1dcr; radar, sonar
			G49	Sulu	1954		
G50			La Union	1955			
G51			Antique	1955			
G52			Masbate	1956			
G53	Misamis Occidental	1956					
			P57	Yindi	1944		

PB	HDML	4	P58	Yarraman	1945		54t, 22.0x4.8x1.4m, 2d, 300hp, 11.5kts, 10p; 2x1-20/70, 2dcr; type 291 radar
			P59	Yanga	1944		
			P60	Yacki	1944		

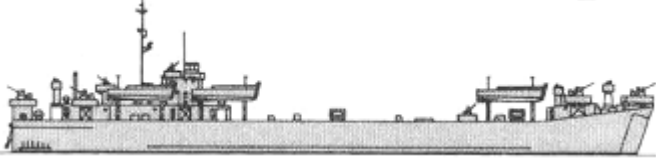
AMPHIBIOUS

LST	LST1	5	T36	Cotabato	1943		4080t, 100.0x15.2x4.3m, 2d, 1800hp, 12.1kts, 125p; (2x2+4x1)-40/60, 12x1-20/70; 4 LCVP, 20tanks, 163troops; radar
			T37	Pampanga	1944		
			T38	Bulacan	1944		
			T39	Albay	1944		
			T40	Misamis Oriental	1944		
LC	LCM(6)	1	LCM224	-	1944		56t, 17.1x4.3x1.2m, 2d, 450hp, 9kts, 5p; 2x1-12.7; 1tank
	LCVP	2	LCVP175, 181	-	1944		13t, 11.2x3.2x0.9m, 2d, 220hp, 8kts, 3p; 2x1-12.7; 36troops

MINE WARFARE



MSC	Bluebird	2	M55	Zambales	1956		400t, 44.2x8.1x2.1m, 2d, 880hp, 12kts, 39p; 1x2-20/70, magnetic, acoustic, mechanical minesweeping gear; SPS-53 radar, UQS-1 sonar
			M56	Zamboanga del Norte	1956		

© Ivan Gogin, 2016



[home](#)[World navies yesterday](#)[1960](#)

Poland 01 January 1960

SUBMARINES



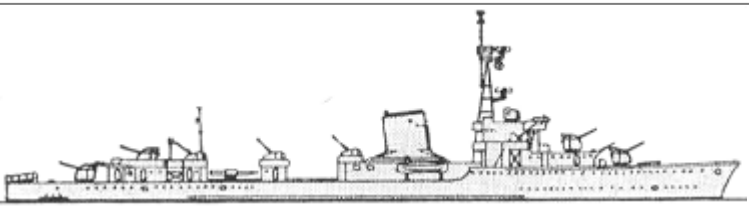

	Orzeł	1	1	Sęp	1939		1473/1650t, 84.0x6.7x4.2m, 2d/em, 4740/1100hp, 19.4/9kts, 60p, 80m; 12-533TT
SS	pr. 96	6	100	Kaszub	1952		280/351t, 49.5x4.4x2.8m, 2d/em, 1200/430hp, 15.5/7.9kts, 23p, 60m; 4-533TT
			101	Mazur	1950		
			102	Krakowiak	1948		
			103	Ślązak	1950		
			104	Kujawiak	1949		
			105	Kurp	1949		

PRINCIPAL SURFACE COMBATANTS

	Burza	1	52	Burza	1932		2240t, 107.2x10.2x3.8m, 3b,2gst, 33000hp, 30kts, 155p; 4x1-100/56, 4x2-37/70, 4dct, 2dcr; Rif-1, Giuys-1B, Rym-1 radars, Tamir-5N sonar		
DD	Grom	1	51	Błyskawica	1937		2183t, 114.0x11.3x3.5m, 4b,2gst, 54000hp, 39kts, 200p; 4x1-100/56, 2x1-37/73, 4x2-37/70, 1x5-533TT, 4dct, 2dcr; Rif-1, Giuys-1B, Rym-1 radars, Tamir-5N sonar		
				pr. 30bis	2	53	Grom	1950	
						54	Wicher	1950	





PATROL AND COASTAL COMBATANTS

	D45	Czajka	1936	
--	-----	--------	------	--





PC	Jaskółka	3	D46	Mewa	1935		203t, 45.0x5.5x1.6m, 2d, 1040hp, 17.5kts, 30p; 1x2-37/70, 1x2-12.7, 2dcr; Zarnitsa radar
			D47	Rybitwa	1935		
			361	Czujny	1953		
	pr. 122bis	8	362	Nieugięty	1953		325t, 51.7x6.6x2.2m, 3d, 3600hp, 20kts, 54p; 1x1-85/52, 2x1-37/73, 2x2-12.7, 2dct, 2dcr, 18mines; Giuys radar, Tamir-9 sonar
			363	Zawzięty	1953		
			364	Zwrotny	1953		
			365	Zwinny	1950		
			366	Zręczny	1950		
			367	Wyrwały	1951		
PT	pr. 183	20	401	KT-83	1956		67t, 25.5x6.2x1.2m, 4d, 6000hp, 43kts, 14p; 2x2-25/80, 2x1-533TT, 2dcr; Zarnitsa radar
			402	KT-84	1956		
			403	KT-85	1956		
			404	KT-86	1956		
			405	KT-87	1956		
			406	KT-88	1957		
			407	KT-89	1957		
			408	KT-90	1957		
			409	KT-71	1958		
			410	KT-72	1958		
			411	KT-73	1958		
			412	KT-74	1958		
			413	KT-75	1958		
			414	KT-76	1958		
			415	KT-77	1958		
			416	KT-78	1958		
			417	KT-79	1958		
418	KT-80	1958					
419	KT-91	1958					
420	KT-92	1958					
PB	pr. 194	2	1	Bitny	1944		74t, 24.8x4.2x1.6m, 2d/1d(2), 2000/70hp, 20kts, 24p; 10belt, 12deck, 12CT; 1x1-45/69, 1x1-37/73, 2x2-12.7, 2dcr
			2	Błyskawiczny	1944		

AMPHIBIOUS





LCT(5)	5	50	ODŚ50	1943		286t, 34.8x10.0x1.3m, 3d, 675hp, 8kts, 11p; 2x1-20/70; 4tanks
		51	ODŚ51	1943		
		53	ODŚ53	1943		
		56	ODŚ56	1943		
		59	ODŚ59	1943		

LCU	MFP-D	2	3	ODD3	1953		239t, 49.8x6.6x1.4m, 3d, 375hp, 10.3kts, 19p; 1x1-85/52, 1x1-37/73; 3tanks, 120troops
			7	ODD7	1953		
	MZ	1	4	ODD4	1943		279t, 46.5x6.5x1.0m, 3d, 450hp, 11kts, 13p; 1x1-85/52, 1x1-37/73; 2tanks, 200troops
	MFP-DM	2	5	ODD5	1953		256t, 49.8x8.6x1.4m, 3d, 375hp, 8kts, 19p; 1x1-85/52, 1x1-37/73; 2tanks, 120troops
6			ODD6	1953			
LC	LCM(3)	3	880	ODM100	1945		52t, 15.3x4.3x1.4m, 2d, 330hp, 8kts, 4p; 2x1-12.7; 1tank
			881	ODM101	1945		
			882	ODM102	1945		

MINE WARFARE

MSO	pr. 254K	3	T61	Żubr	1956		577t, 58.0x8.5x2.3m, 2d, 2200hp, 14kts, 68p; 2x2-37/70, 4x2-12.7, 2dct, 2dcr, 16mines, sweeps; Lin', Rym-K radars, Tamir-10 sonar
			T62	Tur	1957		
			T63	Łoś	1957		
MSO	pr. 254M	9	T64	Dzik	1958		600t, 59.1x8.5x2.3m, 2d, 2200hp, 14.5kts, 77p; 2x2-37/70, 2x2-25/80, 2x2-14.5, 2x2-12.7, 2dct, 16mines, sweeps; Lin', Rym-K radars, Tamir-11 sonar
			T65	Bizon	1958		
			T66	Bóbr	1958		
			T67	Rosomak	1959		
			T68	Delfin	1959		
			T69	Foka	1959		
			T70	Mors	1959		
			T71	Ryś	1959		
			T72	Żbik	1959		
MSB	pr. 151	7	811	TR-41	1955		51t, 27.7x4.0x0.7m, 2d, 300hp, 12kts, 16p; 1x2-25/80, 1x2-14.5, 2dcr, sweeps
			812	TR-42	1955		
			813	TR-43	1956		
			814	TR-44	1956		
			815	TR-45	1956		
			816	TR-46	1956		
			817	TR-47	1956		
	pr. T361	8	K8	TR-51	1958		20t, 15.8x3.4x0.9m, 2d, 300hp, 11.6kts, 9p; 1x2-14.5, sweeps
			K9	TR-52	1958		
			K11	TR-53	1958		
			K12	TR-54	1958		
			K13	TR-55	1958		
			K14	TR-56	1958		
			K15	TR-57	1958		
			K16	TR-58	1958		

BOARD GUARD

PC	R218	1	OP201		1956		190t, 39.4x5.7x1.8m, 2d, 2800hp, 17.5kts, 33p; 2x1-37/73, 2x2-12.7, 2dcr; Reya radar, Tamir-10 sonar	
	OP202	3	OP202		1958		150t, 35.0x5.8x1.5m, 2d, 2400hp, 19kts, 29p; 2x1-37/73, 2x1-12.7, 2dcr; Zarnitsa radar, Tamir-10 sonar	
			OP203		1958			
			OP204		1958			
	pr. 902	3	OP205		1959		193t, 39.0x5.9x1.7m, 2d, 2400hp, 19kts, 33p; 2x1-37/73, 2x2-12.7, 2dcr; Zarnitsa radar, Tamir-10 sonar	
			OP206		1959			
			OP207		1959			
	PB	Wał Pomorski	2	DP51	Wał Pomorski	1943	No picture	210t
				DP52	Lenino	1943		
Tkacz		1	DP86	Tkacz	1943	No picture	100t	
KP101		7	KP101-107		1954-1955	No picture	27t, 21.1x2.7x1.3m, 2d, 360hp, 14kts, 8p; 1x1-12.7	
pr. 361S		10	KP108-117		1956-1957		20t, 15.8x3.4x1.1m, 2d, 300hp, 14kts, 9p; 1x1-12.7	
pr. 361T	11	KP118-128		1958		20t, 15.8x3.4x1.1m, 2d, 300hp, 14kts, 9p; 1x2-14.5		

© Ivan Gogin, 2016



[home](#)[World navies yesterday](#)[1960](#)

Portugal 01 January 1960

SUBMARINES

SS	S	3	S160	Narval	1945		814/990t, 66.1x7.2x4.3m, 2d/em, 1900/1300hp, 14.7/9kts, 48p, 110m; 1x1-102/40, 1x1-20/70, 6-533TT; type 267W radar, sonar
			S161	Náutilo	1945		
			S162	Neptuno	1944		

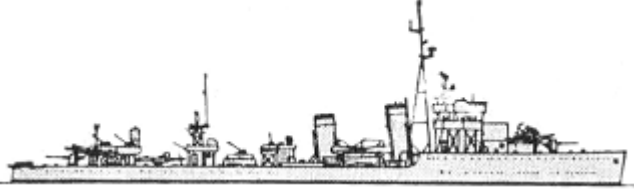
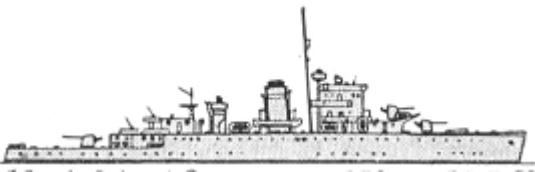
PRINCIPAL SURFACE COMBATANTS

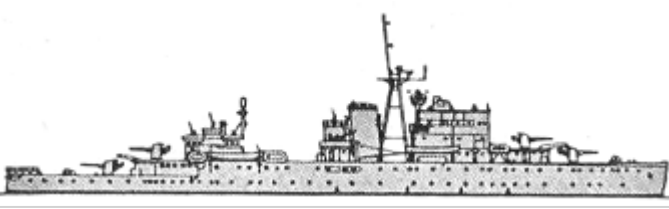
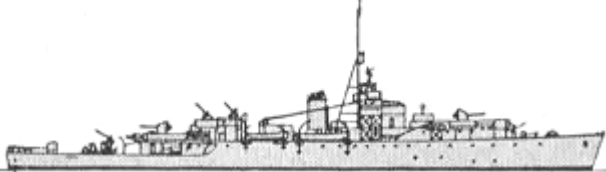
DD	Vouga	4	D331	Dão	1935		1563t, 98.5x9.5x3.4m, 3b,2gst, 33000hp, 36kts, 184p; 2x1-120/50, (1x2+3x1)-40/60, 3x1-20/70, 1x4-533TT, 1x3-305 Squid ASWRL, 2dcr, 20mines; radar
			D333	Lima	1933		
			D334	Vouga	1933		
			D335	Tejo	1935		
	Gonçalo Velho	2	F475	Gonçalo Velho	1933		1414t, 81.7x10.8x3.4m, 2b,2gst, 2000hp, 16.5kts, 142p; 3x1-120/50, 5x1-20/70, 4dct, 2dcr
			F476	Gonçaves Zarco	1933		
	Pedro Nunes	1	F477	João de Lisboa	1937		1220t, 71.4x10.0x2.8m, 2d, 2400hp, 16.5kts, 138p; 2x1-120/50, 4x1-40/60, 4dct, 2dcr
	Afonso de Albuquerque	2	F470	Afonso de Albuquerque	1935		2480t, 103.2x13.5x3.8m, 2b,2gst, 8000hp, 21kts, 184p; 4x1-120/50, 2x1-76/50, 8x1-20/70, 4dct, 2dcr, 40mines; radar
			F471	Bartolomeu Dias	1935		
FF	River	2	F331	Diogo Gomes	1944		2180t, 91.8x11.2x3.8m, 2b,2vte, 5500hp, 20kts, 140p; 2x1-102/40, 6x1-40/60, 2x3-305 Squid ASWRL, 2dcr; type 277, 291 radars, sonars
			F332	Nuno Tristão	1943		
			F333	Diogo Cão	1944		





WGT	2	F334	Corte Real	1944	A line drawing of the Corte Real (F334), a Hedgehog ASWRL, showing its hull, superstructure, and various antennas and sensors.	1811t, 93.3x11.3x3.4m, 2b,2gst, 12000hp, 23kts, 156p; 2x1-127/38, (1x4+3x2)-40/60, 1x24-178 Hedgehog ASWRL, 8dct, 2dcr; SPS-6, SPS-10, Mk25 radars, sonar
		Pêro Escobar	Pêro Escobar	1957	A line drawing of the Pêro Escobar (F335), a Hedgehog ASWRL, showing its hull, superstructure, and various antennas and sensors.	1600t, 98.0x10.9x3.1m, 2b,2gst, 24500hp, 32kts, 165p; 2x1-76/62, 1x2-40/70, 1x3-533TT; MLN-1A radar, QCU-2 sonar
		F336	Álvares Cabral	1945	A line drawing of the Álvares Cabral (F336), a Hedgehog ASWRL, showing its hull, superstructure, and various antennas and sensors.	2420t, 93.7x11.8x3.9m, 2b,2vte, 5500hp, 19.5kts, 177p; 2x2-102/45, (2x2+2x1)-40/60, 1x24-178 Hedgehog ASWRL, 4dct, 2dcr; type 276, 285, 291 radars, sonars
F337	Pacheco Pereira	1945				

PATROL AND COASTAL COMBATANTS

Faro	2	1	Faro	1928	A line drawing of the Faro (1), a patrol boat, showing its hull, superstructure, and various antennas and sensors.	300t, 39.8x6.7x3.2m, 1b,1vte, 650hp, 13kts, 52p; 2x1-47/40
		2	Lagos	1930		
Azevia	5	P595	Azevia	1941	A line drawing of the Azevia (P595), a patrol boat, showing its hull, superstructure, and various antennas and sensors.	270t, 42.6x6.5x2.1m, 2d, 2400hp, 17kts, 37p; 2x1-20/70, 2dct
		P596	Bicuda	1941		
		P597	Corvina	1941		
		P598	Dourada	1942		
		P599	Espadilha	1942		
PC 173ft	6	P581	Principe	1945	A line drawing of the PC 173ft (P581), a patrol boat, showing its hull, superstructure, and various antennas and sensors.	463t, 52.9x7.1x3.3m, 2d, 2880hp, 19kts, 65p; 1x1-40/60, 3x1-20/70, 1x24-178 Hedgehog ASWRL, 4dct; radar, sonar
		P582	Madeira	1945		
		P583	Santiago	1944		
		P584	Sal	1945		
		P585	São Tomé	1944		
		P586	São Vicente	1945		
Maio	8	P587	Maio	1954	A line drawing of the Maio (P587), a patrol boat, showing its hull, superstructure, and various antennas and sensors.	400t, 53.1x7.3x3.1m, 4d(2), 3240hp, 19kts, 62p; 2x1-40/60, 2x1-20/70, 1x24-178 Hedgehog ASWRL, 4dct, 2dcr; Decca radar, DUBA-2 sonar
		P588	Porto Santo	1955		
		P589	São Nicolau	1955		
		P590	Brava	1956		
		P591	Fogo	1956		
		P592	Boavista	1957		
		P593	Santo Antão	1957		

			P594	Santa Luzia	1958		
	Zaire	1	D	Diu	1929		492t, 45.0x8.3x2.1m, 2b,2vte, 700hp, 13kts, 67p; 2x1-76/40, 2x1-20/70, 2dct
PR	Téte	1	P371	Téte	1918	No picture	130t, 23.4x6.1x0.7m, 1b,1vte(sw), 70hp, 8kts, 20p; 2x1-47/43
	Rio Minho	1	P370	Rio Minho	1957	No picture	14t, 15.0x3.2x0.7m, 2d, 130hp, 9kts, 7p
PB	Antares	3	P360	Antares	1959	No picture	18t, 17.1x4.6x1.2m, 2d, 460hp, 18.2kts, 7p; 1x1-20/70
			1	Vega	1959		
			2	Sirius	1959		

MINE WARFARE

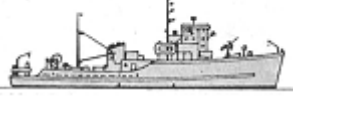
MSO	Tree	1	M391	Faial	1940		770t, 50.0x8.4x3.4m, 1b,1vte, 850hp, 12.2kts, 40p; 1x1-76/40, 2x1-20/70, 2dct, 2dcr, sweeps
	Dance	1	A522	Salvador Correia	1940		770t, 50.0x8.4x3.4m, 1b,1vte, 850hp, 12.2kts, 40p; 1x1-102/45, 3x1-20/70, 2dct, 2dcr, sweeps
	Isle	2	M392	Santa Maria	1942		770t, 50.0x8.4x3.4m, 1b,1vte, 850hp, 12.2kts, 40p; 1x1-76/40, 3x1-20/70, 4dct, 2dcr, sweeps
			A523	Balduque da Silva	1942		
Agile	4	M415	São Jorge	1955		735t, 52.3x10.4x4.0m, 2d, 1520hp, 13kts, 70p; 1x1-40/60, 2x1-12.7, sweeps; SPS-53 radar, UQS-1 sonar	
		M416	Pico	1955			
		M417	Graciosa	1955			
		M418	Corvo	1955			
MSC	Bluebird	7	M405	Ponta Delgada	1953		400t, 44.3x8.1x2.1m, 2d, 880hp, 12kts, 39p; 1x2-20/70, sweeps; SPS-53 radar, UQS-1 sonar
			M406	Horta	1953		
			M407	Angra do Heroísmo	1953		
			M408	Vila do Porto	1953		
			M409	Santa Cruz	1954		
			M410	Velas	1954		
			M411	Lajes	1954		
	Ton	4	M401	São Roque	1956		452t, 46.3x8.5x2.5m, 2d, 2500hp, 15kts, 29p; 1x1-40/60, 1x2-20/70, sweeps; type 978 radar
			M402	Ribeira Grande	1957		
			M403	Lagoa	1956		
			M404	Rosário	1956		

[home](#)[World navies yesterday](#)[1960](#)



Romania 01 January 1960

PRINCIPAL SURFACE COMBATANTS



DD	Mărăști	2	D3	Mărăști	1917		1723t, 94.7x9.5x3.6m, 5b,2st, 45000hp, 34kts, 139p; 2x2-120/45, (1x2+2x1)-37/83, 4x1-20/65, 2x2-13.2, 2x2-450TT, 1dct, 2dcr, 50mines
			D4	Mărășești	1918		
	Regele Ferdinand	2	D9	Regele Ferdinand	1930		1850t, 102.0x9.6x3.5m, 4b,2gst, 52000hp, 37kts, 212p; 4x1-120/50, 1x1-88/45, 2x1-40/67, 4x1-20/65, 2x2-13.2, 2x3-533TT, 2dct, 2dcr, 50mines; S sonar
			D10	Regina Maria	1930		
FS	82F	1	E1	Smeul	1916		330t, 58.8x5.8x1.5m, 2b,2st, 5000hp, 28kts, 41p; 1x1-66/30, 1x1-37/83, 1x1-20/65, 4dct, 2dcr

PATROL AND COASTAL COMBATANTS

PC	Friponne	2	NH112	Locotenent-Comandor Stihi Eugen	1917		443t, 60.2x7.0x2.6m, 2d, 900hp, 14.5kts, 50p; 1x1-88/45, 1x1-37/83, 1x1-20/65, 2dct, mines(1)
			NH113	Locotenent Lepri Remus	1918		
	pr. 122bis	3	V61	-	1955		325t, 51.7x6.6x2.2m, 3d, 3300hp, 20kts, 54p; 1x1-85/52, 2x1-37/63, 2x2-12.7, 2x5 RBU-1200 ASWRL, 1dcr, 18mines; Neptun radar, Tamir-11 sonar
V62	-	1955					
V63	-	1955					
RMON	Ion C. Brătianu	2	M201	Alexandru Lachovari	1908		750t, 63.5x10.5x1.8m, 2b,2vte, 1800hp, 13kts, 110p; 70belt, 70deck, 75turrets, 75CT; 3x1-120/50, 5x1-37/63, 4x1-20/70(201), 2x1-20/70(202), 4x1-12.7(202)
			M202	Ion C. Brătianu	1907		
	Temes	1	M207	Ardeal	1905		650t, 60.3x9.5x1.6m, 2b,2vte, 1400hp, 10kts, 129p; 70belt, 45deck, 75turrets, 75CT, 40CT; 3x1-120/50, 2x1-47/44, 4x1-37/63, 4x1-20/70
	Inn	1	M206	Basarabia	1915		770t, 62.0x10.5x1.8m, 2b,2vte, 1600hp, 12.2kts, 133p; 40belt, 35deck, 50turrets, 40CT; 2x2-120/50, 5x1-37/63, 2x1-20/70, 4x1-12.7
	pr.	6	VT81-	-	1949-1951		22t, 18.7x3.4x0.8m, 2d, 2000hp, 50kts, 7p; 2x2-12.7, 2-450TT, 2dcr

PT	M123bis		86			
	pr. 123K	6	VT87-92	-	1951-1952	 23t, 19.3x3.4x0.8m, 2d, 2000hp, 50kts, 7p; 1x2-14.5, 2-450TT, 2dcr; Zarnitsa radar
PBR	VG10	8	VG10-17	-	1953-1955	No picture 40t, 16.0x4.4x1.2m, 2d, 600hp, 18kts, 10p; 1x1-20/70
	SM161	13	SM161-173	-	1954-1956	No picture 22t, 12.2x3.0x0.9m, 2d, 200hp, 12kts, 8p

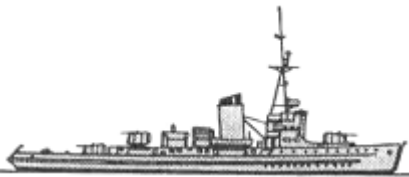
MINE WARFARE

MSO	Democrația	4	13	Democrația	1954		775t, 62.3x8.9x2.6m, 2b,2vte, 2615hp, 17.2kts, 75p; 3x2-37/70, 2x2-14.5, 2dct, 50m, mechanical sweeps
			14	Descătușarea	1954		
			15	Desrobirea	1955		
			16	Dreptatia	1956		
MSI	pr. 255K	25	DR1	-	1956		161t, 38.0x5.7x1.6m, 3d, 690hp, 12kts, 37p; 2x1-45/68, 2x2-12.7, 2dcr, mechanical, magnetic, acoustic sweeps; Tamir-10 sonar
			DR2	-	1956		
			DR3	-	1956		
			DR4	-	1956		
			DR5	-	1957		
			DR6	-	1957		
			DR7	-	1957		
			DR8	-	1957		
			DR9	-	1958		
			DR10	-	1958		
			DR11	-	1958		
			DR12	-	1958		
			DR13	-	1958		
			DR14	-	1958		
			DR15	-	1958		
			DR16	-	1958		
			DR17	-	1958		
			DR18	-	1959		
			DR19	-	1959		
			DR20	-	1959		
			DR21	-	1959		
			DR22	-	1959		
			DR23	-	1959		
			DR24	-	1959		
			DR25	-	1959		
MSR	VD421	8	VD421-428	-	1954-1956		51t, 27.7x4.0x0.7m, 2d, 300hp, 12kts, 16p; 2x2-25/80, 2dcr, mechanical, magnetic, acoustic sweeps



© Ivan Gogin, 2016

[home](#)[World navies yesterday](#)[1960](#)

Singapore 01 January 1960

PATROL AND COASTAL COMBATANTS

PB	Ford	1	P68	Panglima	1956		134t, 35.7x6.1x1.5m, 2d, 1100gph, 14kts, 15p; 1x1-40/60, 1x1-20/70; type 978 radar
----	------	---	-----	----------	------	---	--

AMPHIBIOUS

LC	Brani	2	RPL41	Brani	1955	No picture	56t, 17.0x4.3x1.4m, 2d, 460hp, 9kts, 4p; 1tank
			RPL42	Berlayer	1956		

© Ivan Gogin, 2016

[home](#)[World navies yesterday](#)[1960](#)

South Africa 01 January 1960

PRINCIPAL SURFACE COMBATANTS

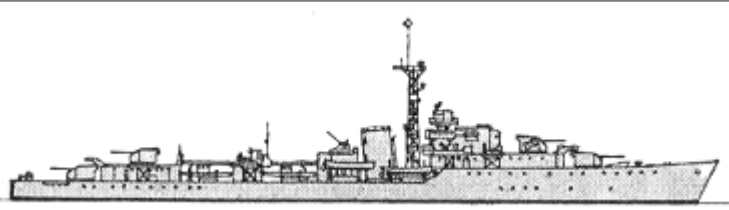
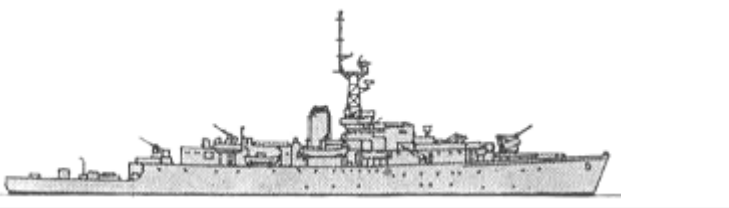
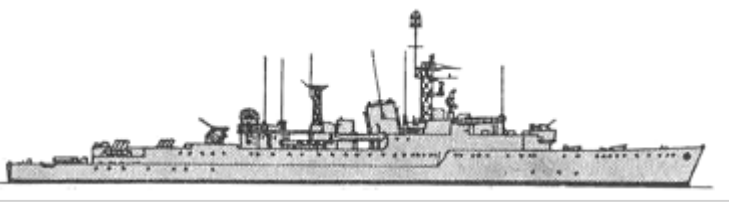

DD	W	2	D278	Jan Van Riebeeck	1944		2545t, 110.6x10.9x4.4m, 2b,2gst, 40000hp, 36.7kts, 225p; 4x1-120/45, 1x1-40/60, 1x4-40/39, 4x2-20/70, 2x4-533TT, 4dct, 2dcr; type 275, 277, 282, 291 radars, type 123A, 127 sonars
			D237	Simon Van der Stel	1944		
FF	Loch	2	F432	Good Hope	1944		2260t, 93.6x11.8x3.8m, 2b,2vte, 5500hp, 19.5kts, 177p; 1x1-102/45, 6x1-40/60, 1x4-40/39, 2x3-305 Squid ASWRL, 2dct, 1dcr; type 277, 291 radars, sonars
			F602	Transvaal	1945		
	W	1	F157	Vrystaat	1944		2850t, 109.2x10.9x4.3m, 2b,2gst, 40000hp, 36.7kts, 195p; 1x2-102/45, 1x2-40/60, 2x3-305 Squid ASWRL; type 278, 262, 293 radars, type 170, 174 sonars

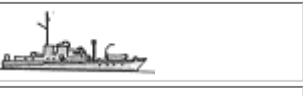
PATROL AND COASTAL COMBATANTS

PB	HDML	8	P1197-1204	SDML1197-1204	1943		54t, 22.0x4.8x1.4m, 2d, 300hp, 11.8kts, 10p; 2x1-20/70, 2dcr; type 291 radar
			Ford	5	P3105	Gelderland	
	P3120	Nautilus			1955		
	P3125	Rijger			1958		
	P3126	Haarlem			1959		
				P3127	Oosterland	1959	

MINE WARFARE

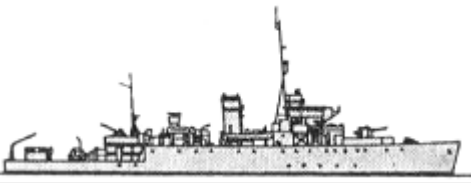
			M439	Bloemfontein	1945		
	Algerine						1325t, 68.6x10.8x3.3m, 2b,2vte, 2400hp, 16.5kts, 138p; 1x1-102/45, 4x2-20/70, 4dct, 2dcr, minesweeping gear;







MSO	VTE	2	M291	Pietermaritzburg	1943		radar, sonar
			M1142	Kaapstad	1954		
MSC	Ton	10	M1144	Pretoria	1954		425t, 46.3x8.8x2.5m, 2d, 3000hp, 15kts, 29p; 1x1-40/60, 1x2-20/70, minesweeping gear; type 978 radar
			M1207	Johannesburg	1958		
			M1210	Kimberley	1958		
			M1212	Port Elizabeth	1958		
			M1213	Mosselbaai	1959		
			M1214	Walvisbaai	1959		
			M1215	East London	1958		
			M1498	Windhoek	1959		
			M1499	Durban	1957		

© Ivan Gogin, 2016

[home](#)[World navies yesterday](#)[1960](#)

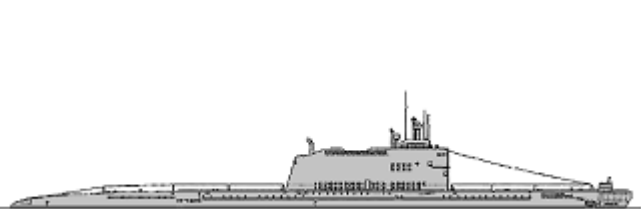
Soviet Union 01 January 1960

SUBMARINES

SSB	pr. V611	1	636	B-67	1956		1875/2387t, 90.5x7.5x5.1m, 3d/em, 6000/5400hp, 16.5/13kts, 72p, 170m; 2 R-11FM SLBM, 10-533TT; Flag radar, Tamir-5LS, Feniks sonars, Nakat ECM
	pr. AV611	4	404	B-73	1957		1890/2400t, 90.5x7.5x5.2m, 3d/em, 6000/5400hp, 16.5/12.5kts, 72p, 170m; 2 R-11FM SLBM, 10-533TT; Flag radar, Tamir-5LS, Feniks sonars, Nakat ECM
			209	B-78	1957		
			210	B-79	1957		
			515	B-89	1957		
	pr. 629	7	801	B-92	1959		2850/3553t, 98.9x8.2x8.1m, 3d/em, 6000/5400hp, 14.5/12.5kts, 83p, 260m; 3 R-11FM SLBM, 6-533TT; Flag radar, MG-200 Arktika-M, Tuloma, Svet sonars, Nakat ECM
			802	B-40	1959		
			803	B-41	1959		
			804	B-42	1959		
			805	B-121	1959		
131			B-93	1959			
132	B-103	1959					
SSG	pr. P613	1	302	S-146	1953		1089/1342t, 76.0x6.3x4.6m, 2d/em, 4000/2700hp, 17.5/11.5kts, 37p, 170m; 1x1 P-5 SSM(1), 6-533TT; Flag radar, Plutoni, Feniks sonars, Nakat ECM
SSN	pr. 627	1	254	K-3	1958		3118/4069t, 107.4x7.9x5.7m, 2nr,2gst, 35000hp, 15.2/30kts, 104p, 240m; 8-533TT; Prizma radar, MG-200 Arktika, Luch, Mars-26KP, MG-13M sonars, Nakat-M ECM
	pr. 627A	3	260	K-5	1959		3118/4053t, 107.3x7.9x5.7m, 2nr,2gst, 35000hp, 15.2/30kts, 104p, 240m; 8-533TT; Prizma radar, MG-200 Arktika-M, Plutoni, MG-10 Kola, MG-13M sonars, Nakat-M ECM
			261	K-8	1959		
			281	K-14	1959		
			114/307	M-215	1947		
			115/308	M-216	1947		
			116/309	M-217	1947		
			117/310	M-218	1947		
			354	M-235	1948		
			373	M-237	1948		
			374	M-238	1948		

pr. 96 36

375	M-239	1949
376	M-240	1949
378	M-242	1949
379	M-243	1949
380	M-244	1949
383	M-247	1949
384	M-248	1949
385	M-249	1949
386	M-250	1950
387	M-251	1950
388	M-252	1950
389	M-253	1950
502	M-272	1950
503	M-273	1950
505	M-275	1950
510	M-280	1951
619	M-281	1951
620	M-282	1951
621	M-283	1951
622	M-284	1951
623	M-285	1952
624	M-286	1952
625	M-287	1952
626	M-288	1952
627	M-289	1952
629	M-291	1952
644	M-292	1953
645	M-293	1953
646	M-294	1953
801	S-80	1951
802	S-43	1952
803	S-44	1952
804	S-45	1952
805	S-46	1952
201	S-140	1953
202	S-141	1953
203	S-142	1953
204	S-143	1953
205	S-144	1953
301	S-145	1953
303	S-147	1953



280/351t, 49.5x4.4x2.8m, 2d/em, 1200/430hp, 15.5/7.9kts, 23p, 60m; 1x1-45/46, 4-533TT

401	S-150	1953
402	S-151	1953
403	S-152	1953
501	S-155	1953
503	S-157	1953
504	S-158	1953
505	S-159	1954
601	S-160	1954
602	S-161	1954
603	S-162	1954
604	S-163	1954
605	S-164	1954
701	S-165	1954
702	S-166	1954
704	S-168	1954
705	S-169	1954
901	S-170	1954
903	S-172	1954
904	S-173	1954
905	S-174	1954
112	S-176	1954
113	S-177	1954
114	S-178	1954
115	S-179	1954
212	S-181	1954
311	S-185	1954
312	S-186	1954
313	S-192	1954
315	S-194	1955
411	S-195	1955
412	S-196	1955
413	S-197	1955
414	S-198	1955
415	S-199	1955
511	S-200	1955
512	S-261	1955
513	S-262	1955
514	S-263	1955
515	S-264	1955
611	S-265	1955



612	S-266	1955
613	S-267	1955
614	S-268	1955
615	S-269	1955
711	S-270	1955
712	S-271	1955
713	S-272	1955
714	S-273	1955
715	S-274	1955
911	S-275	1955
912	S-276	1955
913	S-277	1955
914	S-278	1955
915	S-279	1955
121	S-280	1955
122	S-281	1955
123	S-282	1955
124	S-283	1955
125	S-284	1955
131	S-285	1955
132	S-286	1955
133	S-287	1955
134	S-288	1955
135	S-289	1955
141	S-290	1956
142	S-291	1956
143	S-292	1956
144	S-293	1956
145	S-294	1956
151	S-295	1956
152	S-296	1956
153	S-297	1956
154	S-325	1956
155	S-326	1956
161	S-327	1956
162	S-328	1956
163	S-329	1956
164	S-300	1956
165	S-338	1956
171	S-339	1956
172	S-340	1956

		173	S-341	1956
		174	S-342	1956
		175	S-343	1956
		181	S-344	1956
		183	S-346	1956
pr.	196	184	S-347	1956
613		185	S-348	1956
		191	S-349	1956
		376	S-61 Komsomolets	1952
		377	S-62	1952
		378	S-63	1952
		379	S-64	1952
		380	S-65	1952
		381	S-66	1953
		382	S-67	1953
		406	S-68	1953
		407	S-69	1953
		408	S-70	1953
		409	S-71	1953
		410	S-72	1953
		411	S-73	1953
SS		412	S-74	1953
SSR		413	S-75	1953
		414	S-76	1953
		415	S-77	1954
		416	S-78	1954
		418	S-86	1954
		419	S-87	1954
		420	S-88	1954
		421	S-89	1954
		422	S-90	1954
		424	S-95	1954
		425	S-96	1954
		426	S-97	1954
		427	S-98	1955
		428	S-100	1954
		429	S-217	1954
		430	S-218	1955
		431	S-219	1955
		432	S-220	1955



1045/1342t, 76.0x6.3x4.6m, 2d/em, 4000/2700hp, 18.3/13.1kts, 55p, 170m; 6-533TT; Flag radar, Plutoniyy, Feniks sonars, Nakat ECM

433	S-221	1955
434	S-222	1955
435	S-223	1955
436	S-224	1955
437	S-225	1955
438	S-226	1955
439	S-227	1955
440	S-228	1955
202	S-230	1955
203	S-231	1955
204	S-232	1955
205	S-233	1955
206	S-234	1955
207	S-235	1956
208	S-236	1956
209	S-237	1956
210	S-238	1956
451	S-239	1956
452	S-240	1956
453	S-241	1956
454	S-242	1956
455	S-250	1956
211	S-243	1956
214	S-246	1956
215	S-374	1956
216	S-375	1957
217	S-376	1956
218	S-377	1957
457	S-379	1957
458	S-380	1957
459	S-381	1957
460	S-382	1957
461	S-383	1957
404	S-153	1953
405	S-154	1953
502	S-156	1953
455	S-187	1955
456	S-188	1955
457	S-189	1955
458	S-190	1955

		459	S-191	1955		
		461	S-355	1955		
		462	S-356	1955		
		151	S-357	1955		
		152	S-358	1956		
		153	S-359	1956		
		154	S-360	1956		
		155	S-361	1956		
		251	S-362	1957		
		252	S-363	1957		
		253	S-364	1957		
		254	S-365	1958		
		51	S-331	1954		
		52	S-332	1955		
		53	S-333	1955		
		54	S-334	1955		
		55	S-335	1955		
		56	S-336	1956		
		57	S-337	1956		
		58	S-390	1956		
		59	S-391	1956		
		60	S-392	1957		
		61	S-393	1957		
pr. 613M	1	462	S-384	1957		1045/1342t, 76.0x6.3x4.6m, 2d/em, 4000/2700hp, 18.3/13.1kts, 55p, 170m; 6-533TT; Flag radar, Plutoniyy, Feniks sonars, Nakat ECM
pr. V613	1	201	S-229	1955		1044/1342t, 76.0x11.0x6.4m, 2d/em, 4000/2700hp, 8/4.7kts, 55p, 170m; 1 S4.5 SLBM maquette, 6-533TT; Flag radar, Plutoniyy, Feniks sonars, Nakat ECM
pr. 613Kh	2	182	S-345	1956		1045/1342t, 76.0x6.3x4.6m, 2d/em, 4000/2700hp, 18.3/13.1kts, 55p, 170m; 6-533TT; Flag radar, Plutoniyy, Feniks, MG-25 Yakhta sonars, Nakat ECM
		456	S-378	1957		
		580	B-61	1953		
		631	B-62	1953		
		632	B-63	1954		
		633	B-64	1954		
		634	B-65	1954		
		635	B-66	1954		
		637	B-68	1955		
		638	B-69	1955		
		351	B-70	1956		
		402	B-71	1956		

pr. 611	21	403	B-72	1956
		305	B-74	1956
		306	B-75	1956
		307	B-76	1956
		208	B-77	1956
		111	B-80	1957
		112	B-81	1957
		113	B-82	1957
		514	B-88	1957
		516	B-90	1957
		517	B-91	1958

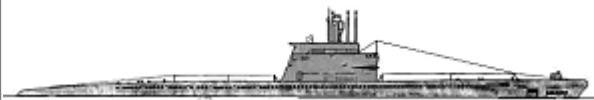



1830/2348t, 90.5x7.5x5.0m, 3d/em, 6000/5400hp, 17/15kts, 65p, 170m; 10-533TT; Flag radar, Tamir-5LS, Feniks sonars, Nakat ECM

pr. A615	27	664	M-255	1955
		667	M-258	1955
		668	M-259	1955
		669	M-260	1956
		1070	M-261	1956
		1071	M-262	1956
		1072	M-263	1956
		1073	M-264	1956
		1074	M-265	1956
		1075	M-266	1956
		1078	M-267	1956
		1079	M-268	1956
		1080	M-269	1957
		701	M-295	1957
		702	M-296	1958
		703	M-297	1957
		704	M-298	1957
		705	M-299	1957
		711	M-300	1957
		713	M-301	1958
		715	M-321	1958
		801	M-351	1956
		802	M-352	1956
		803	M-353	1956
804	M-354	1956		
805	M-355	1957		
816	M-356	1957		



406/504t, 56.8x4.5x3.6m, 3d/1d, 2700/900hp, 16.1/15kts, 41p, 100m; 4-533TT; Flag radar, Tamir-5L, Mars-16KIG sonars

		763	B-94	1958
		764	B-95	1959

pr. 641	6	765	B-36	1959		1952/2475t, 91.3x7.5x5.1m, 3d/em, 6000/5400hp, 16.8/16kts, 77p, 250m; 10-533TT; Flag radar, MG-200 Arktika-M, Tuloma, MG-10 Kola, Svet-M sonars, Nakat ECM
		766	B-37	1959		
		769	B-133	1959		
		770	B-135	1959		
pr. 633	7	331	S-350	1959		1330/1729t, 76.6x6.7x4.6m, 2d/em, 4000/2700hp, 15.2/13kts, 58p, 240m; 8-533TT; Flag radar, MG-200 Arktika-M, Tuloma, Svet-M sonars, Nakat ECM
		332	S-351	1959		
		333	S-352	1959		
		334	S-353	1959		
		335	S-354	1959		
		341	S-32	1959		
342	S-34	1959				
pr. 640	1	305	S-149	1953		1062/1342t, 76.0x6.3x5.1m, 2d/em, 4000/2700hp, 17.5/8.9kts, 56p, 170m; 2-533TT; MR-200 Kasatka, Flag radars, Plutoniya, Feniks sonars, Nakat ECM

PRINCIPAL SURFACE COMBATANTS

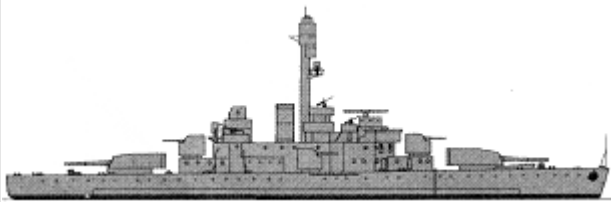
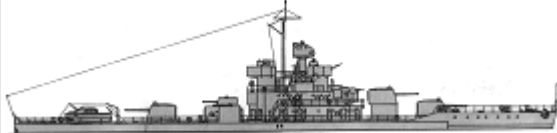
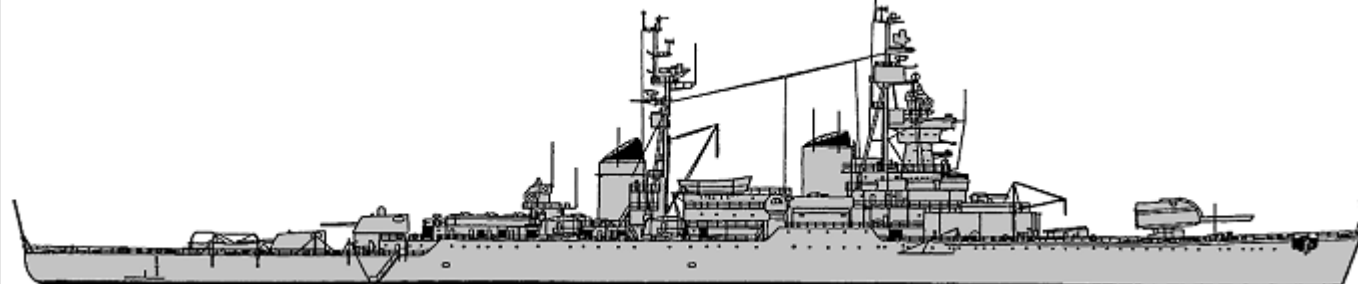
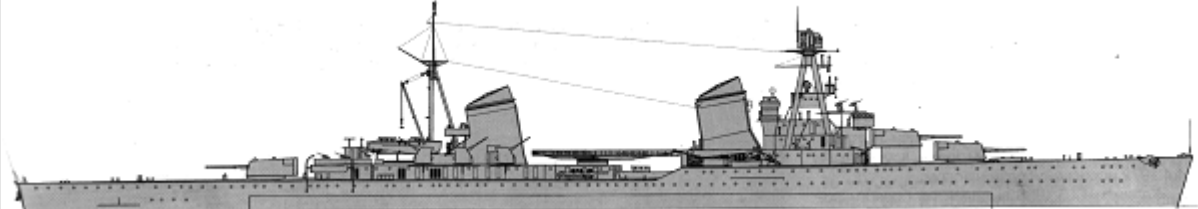
BC	Ilmarinen	1	1	Vyborg	1932		3900t, 93.0ppx16.9x4.5m, 4dg,2em, 6000hp, 15kts, 330p; 55belt, 20deck, 100turrets, 120CT; 2x2-254/45, 4x2-105/50, (1x2+2x1)-40/60, 8x1-20/60
MON	pr. 1190	3	233/9671	Khasan	1942		2400t, 88.0x11.1x2.9m, 4d, 3200hp, 15kts, 242p; 77belt, 40deck, 100turrets, 100CT; 3x2-130/51, 2x2-76/55, 2x2-45/46, 5x2-12.7/79, 29mines
			234/9672	Perekop	1943		
			235/9673	Sivash	1946		
CG	pr. 68EP	1	375	Admiral Nakhimov	1953		16640t, 210.0x22.0x7.4m, 6b,2gst, 110000hp, 32.7kts, 1270p; 100belt, 50deck, 175turrets, 130CT; 1x1 KSShch SSM (4 KSShch), 2x3-152/59, 4x2-100/70, 14x2-37/70, 2x5-533TT, 132mines; Rif, Giuys-2, 2x Neptun, 2x Zalp, 2x Yakor'-M, Zaria radars, Tamir-5N sonar
CA	pr. 26	1	269	Kirov	1938		9287t, 191.3x17.7x6.2m, 6b,2gst, 110000hp, 35kts, 734p; 50belt, 50deck, 50turrets, 150CT; 3x3-180/58, 8x1-100/56, 9x2-37/70, 100mines; Rif, Giuys, Zalp, Yakor' radars
			329	Slava	1941		
			7	Kalinin	1942		

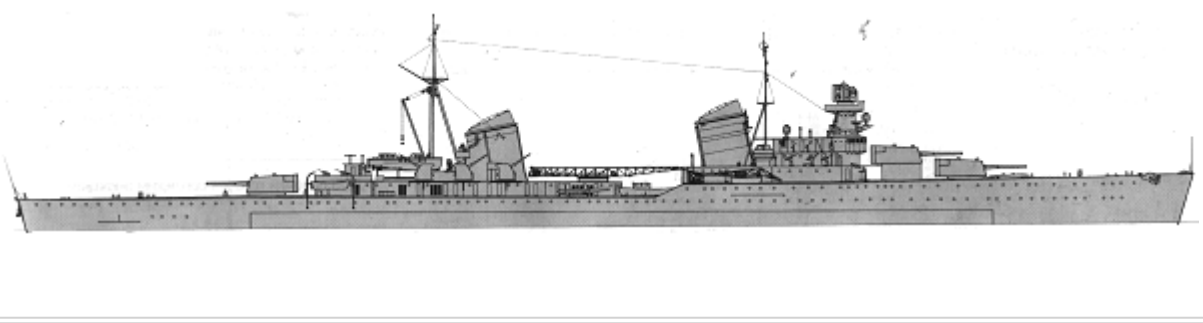
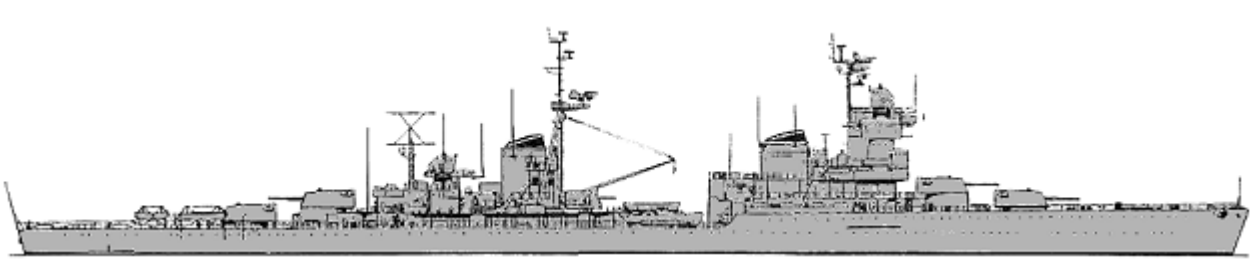
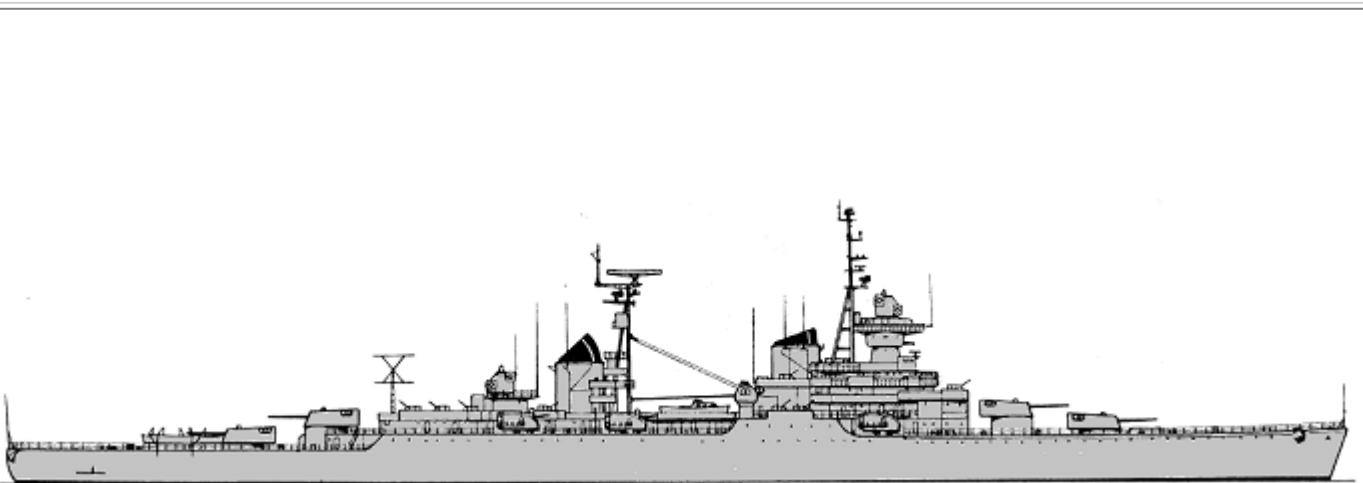
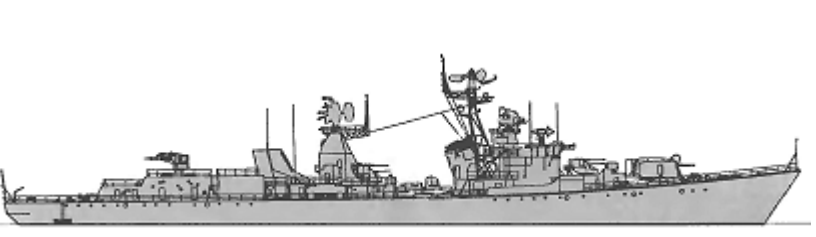
	pr. 26bis	3	8	Petropavlovsk	1944		3x3-180/58, 6x1-100/56(329), 8x1-85/52(7,8), 19x1-37/73(7), 21x1-37/73(8), 11x2-37/70(329), 6x1-12.7(7,8), 2x3-533TT(7,8), 4dct(7,8), 2dcr(7,8), 100mines; 2x type 282(7,8), 2x 285(8), 291(8), SG(7,8), 281(7,8), 2x Yupiter-1(7), Rif(329), Giuys(329), Zalp(329), Yakor'(329) radars
CL	pr. 68K	5	545	Zheleznyakov	1950		14138t, 199.2x18.7x6.9m, 6b,2gst, 110000hp, 32.8kts, 1184p; 100belt, 50deck, 175turrets, 130CT; 4x3-152/57, 4x2-100/70, 14x2-37/70, 2x5-533TT, 146mines; Giuys-1M4, Rif, P-10(306), Fut-N(545,1088), 2x Redan-2, 2x Vympel-2, Neptun radars, Tamir-5N sonar
			1088	Kuybyshev	1950		
			305	Chapaev	1950		
			306	Komsomolets	1950		
			356	Frunze	1950		
	pr. 68bis	13	408	Sverdlov	1952		16640t, 210.0x22.0x7.4m, 6b,2gst, 110000hp, 32.7kts, 1270p; 100belt, 50deck, 175turrets, 130CT; 4x3-152/59, 6x2-100/70, 16x2-37/70, 2x5-533TT, 132mines; Rif, Giuys-2, P-8(301,385,445), P-500 Kliver(445,625), 2x Neptun, 2x Zalp, 2x Yakor'(408,600,419), 2x Yakor'-M(625,374,420,626,436,301,437,445,385), 2x Yakor'-M2(302), Zaria radars, Tamir-5N sonar, Korall(374), Krab(374,419,437), Krab-11(374,420) ECM
			419	Zhdanov	1952		
			420	Admiral Ushakov	1953		
			436	Aleksandr Suvorov	1953		
			437	Admiral Senyavin	1954		
			445	Dmitriy Pozharskiy	1954		
			374	Dzerzhinskiy	1952		
			385	Mikhail Kutuzov	1954		
600			Ordzhonikidze	1952			
625			Aleksandr Nevskiy	1952			
626	Admiral Lazarev	1952					
301	Oktyabrskaya Revoliutsiya	1954					
302	Murmansk	1955					
DDG	pr. 56K	1	1203	Bravy	1956		3447t, 126.1x12.8x4.5m, 4b,2gst, 72000hp, 35.5kts, 270p; 1x2 Volna M-1 SAM(16), 1x2-130/58, 1x4-45/89, 1x5-533TT, 2x16 RBU-2500 ASWRL, 6dct, 2dcr; MR-300 Angara, Neptun, Yakor'-M1, 4R-90 Yatagan, Fut-B, Zaria radars, Pegas-2 sonar, Machta-P4 ECM
	pr. 56EM	1	1204	Bedovyy	1958		3390t, 126.1x12.7x4.5m, 4b,2gst, 72000hp, 37kts, 270p; 1x1 KSShch SSM(8), 4x4-45/89, 2dcr; Rif-A, Zalp-Shch, 2x Fut-B radars, Pegas-2M sonar, Bizan'-4A ECM, Planshet-56M CCS

pr. 56M	3	1210	Prozorlivyy	1958		3315t, 126.x12.7x4.3m, 4b,2gst, 72000hp, 39kts, 270p; 1x1 KSShch SSM(8), 4x4-57/75, 2x2-533TT, 2x16 RBU-2500 ASWRL, 2x6 RBU-36U ASWRL, 2dcr; Fut-N, Rif-Shch, Don, Kivach, Zalp-Shch, 2xFut-B radars, Gerkules-2M(1210,743), Gerkules(88) sonar, Bizan'-4A ECM, Planshet-56M CCS
		743/765	Neulovimyy	1958		
		88	Neuderzhimyy	1958		
pr. 7	1	1075	Razumnyy	1941		2039t, 112.8x10.2x3.3m, 3b,2gst, 48000hp, 35kts, 246p; 4x1-130/50, 4x2-37/70, 2x3-533TT, 2dct, 2dcr, 60mines; Giuys-1, Rif-1, Vympel-2 radars, Tamir-5N sonar
pr. 7U	2	518	Vitse-admiral Drozd	1940		2404t, 112.8x10.2x5.0m, 4b,2gst, 54000hp, 34kts, 273p; 4x1-130/51, 4x2-37/70, 2x3-533TT, 2dct, 2dcr, 60mines; Giuys-1, Rif-1, Vympel-2 radars, Tamir-5N sonar
		293	Slavnyy	1941		
pr. 30K	1	538	Otlichnyy	1948		2860t, 117.0x11.0x4.7m, 4b,2gst, 54000hp, 36.5kts, 301p; 2x2-130/51, 1x2-85/52, 6x1-37/73, 2x3-533TT, 2dct, 2dcr, 60mines; Giuys-1b, Rif-1, Vympel-2, Rym-1 radars, Tamir-5N sonar
		1101	Bditelnyy	1949		
		1102	Bezuderzhnyy	1949		
		1103	Buynyy	1950		
		1104	Bezuprechnyy	1950		
		1105	Besstrashnyy	1950		
		1107	Bystryy	1950		
		1108	Burnyy	1951		
		1109	Besposhchadnyy	1951		
		1112	Besshumnyy	1951		
		1114	Bezboyaznennyy	1952		
		1115	Bezotkaznyy	1952		
		1116	Bezukoriznennyy	1952		
		1117	Bessmennyy	1952		
		6	Vstrechnyy	1949		



9	Vedushchiy	1949
12	Vazhnyy	1949
13	Vspylchivyy	1950
14	Velichavyy	1950
15	Viortkiy	1950
16	Vechnyy	1950
17	Vikhrevoy	1950
18	Vidnyy	1951
19	Vernyy	1951
21	Vnimatelnyy	1951
24	Volnyy	1952
25	Vkradchivyy	1952
26	Vdumchivyy	1952
27	Vrazumitelnyy	1953
601	Smelyy	1949
602	Stoykiy	1950
604	Surovyy	1950
605	Serdityy	1950
607	Stremitelnyy	1951
608	Sokrushitelnyy	1951
609	Svobodnyy	1952
610	Statnyy	1952
612	Smotriashchiy	1952
613	Sovershennyy	1952
616	Seryoznyy	1952
618	Stepennyy	1953
619	Pylkiy	1952
178	Ognennyy	1949
179	Otchotlivyy	1949
180	Ostryy	1950
181	Otvetstvennyy	1950
182	Otmennyy	1950
183	Otryvistyy	1950
184	Otrazhayushchiy	1950
188	Otradnyy	1951
189	Ozariionnyy	1951
190	Oberegayushchiy	1951
191	Okhranyayushchiy	1951
192	Ostorozhnyy	1951
193	Okrylionnyy	1951
194	Otzyvchivyy	1952

pr. 30bis 59

DD

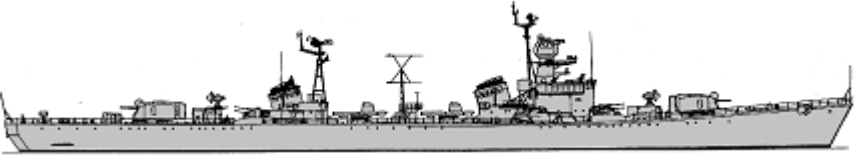

3066t, 120.5x12.0x4.3m, 4b,2gst, 60000hp, 35.5kts, 286p; 2x2-130/51, 1x2-85/52, 7x1-37/73(6,9,12-14,601-606,1101,1103), 4x2-37/70(15-19,21,24-27,178-184,188-198,607-613,616-619,1102,1104,1105,1107-1109,1112,1114-1117), 2x5-533TT, 6dct, 2dcr, 60mines; Giuys-1M(1101-1105,1107-1109,1112,1114-1117,6,9,12-19,21,24-27,601-613,616-619,178-184,188-194,196-198), Giuys-1M4(195), P-10, Rif-1, Rym-1, Redan(1101-1104,1107-1109,1112,1114-1117,6,9,12-19,21,24-27,601-611,619,178-184,188-194,196-198), Zalp(195,1105,612,613,616-618), Vympel-2, Redan-4(601-611), Zaria(612,613,616-618) radars, Tamir-5N(1101-1105,1107-1109,1112,1114-1116,6,9,12-19,21,24-27,601-613,616-619,178-184,188-194,196-198), Pegas-2(195,1117) sonar

		195	Otchayanny	1952		
		196	Opasnyy	1952		
		197	Ozhivlionnyy	1953		
		198	Ozhestochionnyy	1953		
pr. 30BK	3	1106	Boevoy	1950		3066t, 120.5x12.0x4.3m, 4b,2gst, 60000hp, 35.5kts, 286p; 2x2-130/51, 1x2-85/52, 4x2-37/70, 2x5-533TT, 6dct, 2dcr, 60mines; Giuys-1M, P-10, Rif-1, Rym-1, Redan, Vympel-2 radars, Tamir-5N sonar
		1110	Bezzhalostnyy	1949		
		22	Vyrazitelnyy	1951		
pr. 41	1	614	Neustrashimyy	1955		3830t, 134.0x13.6x4.4m, 4b,2gst, 64200hp, 33.5kts, 305p; 2x2-130/58, 4x2-45/89, 2x4-25/112, 2x5-533TT, 6dct, 2dcr, 48mines; Rif, Yakor'-M, Fut-B, Zaria radars, Pegas-2 sonar
pr. 56	26	701	Spokoynyy	1956		3230t, 126.1x12.8x4.3m, 4b,2gst, 72000hp, 38kts, 284p; 2x2-130/58, 4x4-45/89, 2x5-533TT, 6dct, 2dcr, 50mines, helodeck(702); Rif(704,705,710,1201,1202), Fut-N(701-703,706-709,741,742,1205-1209,81-87), Neptun, Yakor'-M1, 2x Fut-B, Zaria(81-87,701-710,742,1201,1202,1205-1209), Volna(741) radars, Pegas-2 sonar, Machta-P4(81-87,703-710,741,742,1201,1202,1205-1209) ECM
		702	Svetlyy	1955		
		703	Speshnyy	1955		
		704	Skromnyy	1955		
		705	Svedushchiy	1956		
		706	Moskovskiy Komsomolets	1956		
		707	Skrytnyy	1956		
		708	Soznatelnyy	1956		
		709	Spravedlivyy	1956		
		710	Nesokrushimyy	1957		
		741	Nakhodchivyy	1957		
		742	Nastoychivyy	1957		
		1201	Blestyashchiy	1955		
		1202	Byvalyy	1955		
		1205	Besslednyy	1956		
		1206	Burlivyy	1956		
		1207	Blagorodnyy	1957		
		1208	Plamennyy	1957		
		1209	Naporistyy	1957		
		81	Vyzyvayushchiy	1956		
82	Veskiy	1956				
83	Vdokhnovennyy	1956				
84	Vozmushchionnyy	1956				
85	Vozbuzhdionnyy	1957				
86	Vliyatelnyy	1957				
87	Vyderzhannyy	1957				

FF	pr. 42	8	100	Sokol	1952		<p>1679t, 96.1x11.0x4.0m, 2b,2gst, 27820hp, 29.6kts, 211p; 4x1-100/56, 2x2-37/70, 1x3-533TT, 2x16 RBU-2500 ASWRL, 4dct, 2dcr; Rif, Giuys-1MN, Visla radars, Tamir-5N sonar, Bizan'-4 ECM</p>
			101	Berkut	1952		
			102	Kondor	1952		
			103	Grif	1952		
			104	Krechet	1952		
			105	Orlan	1953		
			106	Lev	1953		
			107	Tigr	1953		
	pr. 50	62	1120	Gornostay	1954		
			1121	Pantera	1954		
			1122	Rys'	1954		
			1123	Yaguar	1954		
			1124	Sarych	1954		
			1125	Puma	1954		
			1126	Volk	1954		
			1127	Kunitsa	1954		
			1128	Korsak	1954		
			1129	Norka	1955		
			1130	Voron	1955		
			1131	Grizon	1955		
			1132	SKR-51	1955		
1133			SKR-52	1955			
1135			SKR-57	1956			
1136			SKR-58	1956			
1137			SKR-63	1956			
1138			SKR-66	1956			
108			Leopard	1954			
109			Bars	1954			
110			Rosomakha	1954			
112			Barsuk	1954			
113			Kuguar	1954			
115	Filin	1954					
116	Lun'	1954					
117	Kobchik	1955					
119	Los'	1955					
194	SKR-50	1956					
131	SKR-54	1955					
160	SKR-55	1955					
173	SKR-56	1956					
147	SKR-59	1956					
						<p>1337t, 90.9x10.2x2.9m, 2b,2gst, 20000hp, 29kts, 168p; 3x1-100/56, 2x2-37/70, 1x2-533TT, 2x24 MBU-200 ASWRL, 4dct, 2dcr; Giuys-1M4, Lin', Don, Yakor'</p>	



149	SKR-60	1956
151	SKR-61	1956
155	SKR-62	1956
156	SKR-64	1956
161	SKR-65	1956
167	SKR-68	1957
125	SKR-69	1957
126	SKR-70	1957
127	SKR-71	1957
128	SKR-72	1957
129	SKR-73	1957
130	SKR-74	1957
132	SKR-75	1957
133	SKR-76	1958
134	SKR-77	1958
136	SKR-80	1958
138	SKR-81	1958
139	SKR-10	1958
140	SKR-4	1958
141	SKR-5	1958
142	SKR-8	1958
143	SKR-14	1959
144	SKR-15	1959
41	Zubr	1954
42	Bizon	1954
43	Aist	1954
44	Laska	1954
45	Pelikan	1954
46	Pingvin	1954
47	Gepard	1954



radars, Pegas-2M sonar, Bizan'-4 ECM

PATROL AND COASTAL COMBATANTS

PG	Ukrayna	2	1	Bakinskiy Rabochiy	1905		880t, 73.2x7.2x3.4m, 4b,2vte, 7000hp, 26kts, 88p; 3x1-102/60, 2x1-45/46, 2x1-37/73, 4x1-12.7, 25mines
			3	3-y DOSAAF	1905		
							325t, 51.7x6.6x2.2m, 3d, 3600hp, 20kts, 54p; 1x1-85/52, 2x1-37/73, 2x2-12.7, 2x5 RBU-1200

DV	pr. 122bis	1	367	PS-6	1947		ASWRL, 1dcr, 18mines; Lin' or Neptun radar, Tamir-10 or Tamir-11 sonar
	Admirable	2	2	Gydan	1944		945t, 56.2x10.1x3.0m, 2d, 2000hp, 15.1kts, 96p; 1x1-76/50, 2x1-40/60, 6x1-20/70, mechanical, magnetic, acoustic sweeps
			3	Aydar	1943		
pr. 43	1	28	Kushum	1936		580t, 62.0x7.2x3.0m, 2d, 2200hp, 17.2kts, 61p; 1x1-102/60, 3x1-37/73, 6x1-12.7, 2dct	
			932	MPK-159	1955		
			368	MPK-171	1947		
			438	MPK-183	1948		
			439	MPK-184	1948		
			442	MPK-187	1948		
			445	MPK-190	1948		
			447	MPK-192	1949		
			448	MPK-193	1949		
			449	MPK-194	1949		
			450	MPK-195	1949		
			451	MPK-196	1949		
			454	MPK-199	1949		
			455	MPK-200	1949		
			456	MPK-201	1949		
			457	MPK-247	1949		
			458	MPK-248	1949		
			459	MPK-249	1949		
			460	MPK-250	1949		
			462	MPK-252	1949		
			463	MPK-253	1949		
			464	MPK-254	1949		
			467	MPK-272	1949		
			468	MPK-273	1950		
			469	MPK-274	1950		
			470	MPK-275	1950		
			471	MPK-276	1950		
			472	MPK-277	1950		
			473	MPK-278	1950		
			477	MPK-282	1950		
			478	MPK-283	1950		



479	MPK-284	1950
480	MPK-285	1950
481	MPK-286	1950
482	MPK-287	1950
484	MPK-289	1950
487	MPK-292	1950
488	MPK-293	1950
489	MPK-294	1950
490	MPK-295	1950
492	MPK-297	1950
493	MPK-298	1950
494	MPK-299	1950
495	MPK-300	1950
496	MPK-334	1951
499	MPK-337	1951
500	MPK-338	1951
501	MPK-339	1951
502	MPK-340	1951
503	MPK-341	1951
504	MPK-342	1951
505	MPK-343	1951
510	MPK-348	1951
511	MPK-349	1951
512	MPK-350	1951
513	MPK-351	1951
514	MPK-352	1951
515	MPK-353	1951
516	MPK-354	1951
517	MPK-356	1951
518	MPK-357	1951
519	MPK-358	1951
520	MPK-359	1951
521	MPK-360	1951
522	MPK-361	1951
523	MPK-362	1951
524	MPK-363	1951
525	MPK-364	1951
526	MPK-365	1951
531	MPK-370	1952
532	MPK-371	1952
534	MPK-373	1952











PC pr. 122bis 133

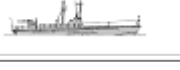

325t, 51.7x6.6x2.2m, 3d, 3600hp, 20kts, 54p; 1x1-85/52, 2x1-37/73, 2x2-12.7, 2x5 RBU-1200 ASWRL, 1dcr, 18mines; Lin' or Neptun radar, Tamir-10 or Tamir-11 sonar

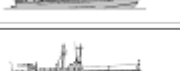
535	MPK-374	1952
539	MPK-378	1952
542	MPK-381	1952
543	MPK-382	1952
544	MPK-383	1952
545	MPK-384	1952
546	MPK-385	1952
547	MPK-386	1952
555	MPK-394	1953
559	MPK-398	1953
560	MPK-399	1953
561	MPK-400	1953
562	MPK-401	1953
563	MPK-402	1953
564	MPK-403	1953
570	MPK-409	1953
571	MPK-410	1953
574	MPK-413	1953
575	MPK-414	1953
576	MPK-415	1953
577	MPK-416	1953
580	MPK-419	1953
581	MPK-420	1953
582	MPK-421	1953
583	MPK-422	1953
592	MPK-431	1954
593	MPK-432	1954
594	MPK-433	1954
595	MPK-434	1954
800	MPK-435	1954
801	MPK-436	1954
802	MPK-437	1954
803	MPK-438	1954
804	MPK-439	1954
805	MPK-440	1954
806	MPK-446	1954
807	MPK-447	1954
808	MPK-448	1954
809	MPK-449	1954
810	MPK-450	1954

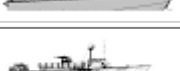
			811	MPK-451	1954		
			812	MPK-452	1954		
			813	MPK-453	1954		
			824	MPK-454	1954		
			825	MPK-455	1954		
			826	MPK-456	1954		
			827	MPK-457	1954		
			828	MPK-458	1954		
			829	MPK-459	1954		
			830	MPK-460	1954		
			831	MPK-461	1954		
			832	MPK-462	1954		
			833	MPK-463	1955		
			900	MPK-464	1955		
			901	MPK-465	1955		
			905	MPK-469	1955		
			906	MPK-470	1955		
			907	MPK-471	1955		
			913	MPK-477	1955		
			915	MPK-479	1955		
			916	MPK-480	1955		
			917	MPK-155	1955		
	pr. 254V	2		KVN-50	1955		594t, 58.0x8.5x2.2m, 2d, 2200hp, 14.5kts, 87p; 2x2-37/70, 1x2-25/112, 2dct; MR-200 Kaktus or MR-500 Kliver, Lin' radars
				KVN-...	1955		
	pr. 256	4	137	KVN-12	1954		577t, 58.0x8.5x2.3m, 2d, 2200hp, 14.5kts, 87p; 2x2-37/70, 4x2-12.7; 2x P-10, Lin' radars
			138	KVN-13	1954		
			141	KVN-9	1954		
			142	KVN-10	1954		
PCR	pr. 258	15	141	KVN-...	1952		594t, 58.0x8.5x2.2m, 2d, 2200hp, 14.5kts, 87p; 2x2-37/70, 1x2-25/112, 2dct; MR-200 Kaktus or MR-500 Kliver, Lin' radars
			144	KVN-6	1952		
			146	KVN-19	1952		
			154	KVN-20	1953		
			159	KVN-1	1953		
			160	KVN-2	1953		
			173	KVN-3	1954		
			127	KVN-5	1953		
			129	KVN-25	1953		
			20	KVN-35	1954		
25	KVN-14	1954					

			42	KVN-27	1955		
			44	KVN-22	1955		
			712	KVN-15	1955		
			713	KVN-16	1955		
			715	KVN-17	1955		
	pr. 258M	1	513	KVN-18	1955		594t, 58.0x8.5x2.2m, 2d, 2200hp, 14.5kts, 87p; 2x2-37/70, 1x2-25/112, 2dct; MR-500 Kliver, Lin' radars
PM	pr. 183E	2		TK-14, 15	1957		81t, 25.5x6.2x1.4m, 4d, 4800hp, 38kts, 17p; 2x1 P-15 SSM, 1x2-25/112; Rangout, Klion-183R radars
	pr. 183R/TR	16?		?TK-63,64,66,81,83,87,88,90,98,101,102,115-119	1959		81t, 25.5x6.2x1.4m, 4d, 4800hp, 38kts, 17p; 2x1 P-15 SSM, 1x2-25/112; Rangout, Klion-183R radars
PTH	pr. 183T	1		TK-...	1953		77t, 25.5x6.2x1.2m, 4d,1gt(5), 8800hp, 49.7kts, 15p; 2x2-25/112, 2-533TT; Zarnitsa radar
	pr. K123K	7		TK-289,290,551,555,557,725,996	1951 - 1955		23t, 19.3x3.4x0.8m, 2d, 2000hp, 54kts, 7p; 1x2-14.5, 2x1-450TT, 6dc; Zarnitsa radar
	pr. 183TK	25?		?TK-39-51, ...	1955 - 1958		79t, 25.5x6.2x1.4m, 4d,1gt, 8800hp, 48.5kts, 15p; 2x2-25/112, 2-533TT; Reya radar
PT	pr. 123bis	50?		?TK-726-740, 940-957, 972, 980-995	1946 - 1948		21t, 18.7x3.4x1.2m, 2pe, 2400hp, 48kts, 7p; 2x2-12.7, 2-450TT
	pr. M123bis	30?		?TK-945-957, 980-996	1949 - 1951		22t, 18.7x3.4x0.8m, 2d, 2000hp, 50kts, 7p; 2x2-12.7, 2-450TT, 6dc
	pr. 123K	81?		?TK-2-6, 8-12, 21-26, 29, 30, 173, 248, 250, 274-288,291-301, 337-349, 405-415, 552-554,556,558, 575, 576, 637-639	1951 - 1955		23t, 19.3x3.4x0.8m, 2d, 2000hp, 50kts, 7p; 1x2-14.5, 2x1-450TT, 6dc; Zarnitsa radar
	pr. 183	235?		?TK-20, 27, 28, 61-67, 69, 72, 112-114, 151-161, 172, 174, 175, 192-199, 221-247, 251-254, 267-271, 851-889, 962-979, 1000, 1031-1089, 1101, 1102, 1107-1114, 1116-1122	1949 - 1959		67t, 25.5x6.2x1.2m, 4d, 4800hp, 43kts, 14p; 2x2-25/112, 2-533TT, 8dc; Zarnitsa radar
	pr. 183U	1		TK-38	1957		92t, 27.3x6.2x1.5m, 2d, 6600hp, 47kts, 15p; 2x2-25/112, 4-533TT, 2dcr; Reya radar
	pr. 184	2		TK-327, 328	1956		34t, 21.6x5.0x2.1m, 3d, 3600-4500hp, 46-62kts, 10p; 2x2-14.5, 2-5333TT; Zarnitsa radar
PG	pr. 186	11	2	BK-522	1945		166t, 36.2x5.2x1.5m, 2d, 1000hp, 14kts, 42p; 20belt, 20deck, 90turrets, 20CT; 2x1-85/55, 1x1-37/73, 2x2-12.7, 2x1-82/12mortars
			9	BK-529	1946		
			10	BK-530	1946		
			11	BK-531	1946		
			25	BK-545	1947		
			26	BK-546	1947		
			27	BK-547	1947		
			28	BK-548	1947		
			29	BK-549	1947		
			30	BK-550	1947		

		31	BK-554	1947		
pr. 201	12	1	MPK-33	1955/58		200t, 39.6x6.0x1.8m, 3d, 6000hp, 24kts, 27p; 1x1-45/89, 1x2-25/112, 4x5 RBU-1200 ASWRL, 2dcr, 18mines; Reya radar, Tamir-11 sonar
		2	MPK-35	1955/58		
		3	MPK-37	1955/58		
		4	MPK-...	1955/58		
		5	MPK-...	1955/58		
		6	MPK-...	1955/58		
		7	MPK-...	1955/58		
		8	MPK-...	1955/58		
		9	MPK-...	1955/58		
		10	MPK-...	1955/58		
		11	MPK-...	1955/58		
		12	MPK-...	1955/58		
		1	MPK-...	1958/59		
		2	MPK-...	1958/59		
		3	MPK-...	1958/59		
		4	MPK-...	1958/59		
		5	MPK-...	1958/59		
		6	MPK-...	1958/59		
		7	MPK-...	1958/59		
		8	MPK-...	1958/59		
		9	MPK-...	1958/59		
		10	MPK-...	1958/59		
		11	MPK-...	1958/59		
		12	MPK-...	1958/59		
		13	MPK-...	1958/59		
		14	MPK-...	1958/59		
		15	MPK-...	1958/59		
		16	MPK-...	1958/59		
17	MPK-...	1958/59				
18	MPK-...	1958/59				
19	MPK-...	1958/59				
20	MPK-...	1958/59				
21	MPK-...	1958/59				
22	MPK-...	1958/59				
23	MPK-...	1958/59				
24	MPK-...	1958/59				
25	MPK-...	1958/59				
26	MPK-...	1958/59				
27	MPK-...	1958/59				
28	MPK-...	1958/59				

PB

pr. 201M 84

29	MPK-...	1958/59
30	MPK-...	1958/59
31	MPK-...	1958/59
32	MPK-...	1958/59
33	MPK-...	1958/59
34	MPK-...	1958/59
35	MPK-...	1958/59
36	MPK-...	1958/59
37	MPK-...	1958/59
38	MPK-...	1958/59
39	MPK-...	1958/59
40	MPK-...	1958/59
41	MPK-...	1958/59
42	MPK-...	1958/59
43	MPK-...	1958/59
44	MPK-...	1958/59
45	MPK-...	1958/59
46	MPK-...	1958/59
47	MPK-...	1958/59
48	MPK-...	1958/59
49	MPK-...	1958/59
50	MPK-...	1958/59
51	MPK-...	1958/59
52	MPK-...	1958/59
53	MPK-...	1958/59
54	MPK-...	1958/59
55	MPK-...	1958/59
56	MPK-...	1958/59
57	MPK-...	1958/59
58	MPK-...	1958/59
59	MPK-...	1958/59
60	MPK-...	1958/59
61	MPK-...	1958/59
62	MPK-...	1958/59
63	MPK-...	1958/59
64	MPK-...	1958/59
65	MPK-...	1958/59
66	MPK-...	1958/59
67	MPK-...	1958/59
68	MPK-...	1958/59





216t, 41.7x6.2x1.9m, 3d, 6600hp, 25kts, 27p; 2x2-25/112, 4x5 RBU-1200 ASWRL, 2dcr, 18mines; Reya radar, Tamir-11 sonar

			69	MPK-...	1958/59		
			70	MPK-...	1958/59		
			71	MPK-...	1958/59		
			72	MPK-...	1958/59		
			73	MPK-...	1958/59		
			74	MPK-...	1958/59		
			75	MPK-...	1958/59		
			76	MPK-...	1958/59		
			77	MPK-...	1958/59		
			78	MPK-...	1958/59		
			79	MPK-...	1958/59		
			80	MPK-...	1958/59		
			81	MPK-...	1958/59		
			82	MPK-...	1958/59		
			83	MPK-...	1958/59		
			84	MPK-...	1958/59		
	PTC	1		SK-527	1943 - 1944		27t, 19.2x4.6x1.2m, 2pe, 1260hp, 25kts, 12p; 1x1-20/70, 2x2-12.7, 8dc
	pr. D361	90?		SK-...	1951 - 1959		18t, 15.8x3.4x0.9m, 2d, 300hp, 14kts, 9p; 1x2-12.7
	pr. 199	2		SK-15, 621	1958 - 1959		83t, 25.5x6.2x1.5m, 4d, 4800hp, 35kts, 23p; 2x2-25/112, 2dct, 2dcr; Zarnitsa radar, Tamir-11 sonar
	pr. 1124	4		BK-162 Eyskiy Patriot, 163 Saratovskiy Patriot, 431, 436	1944 - 1946		52t, 25.3x4.0x0.9m, 2pe, 1500hp, 18kts, 17p; 7belt, 4deck, 45turrets, 8CT; 2x1-76/42, 1x1-37/73, 1x2-12.7
	pr. 1125	1		BK-13	1946		30t, 22.7x3.5x0.6m, 1pe, 750hp, 19.7kts, 13p; 7belt, 4deck, 45turret, 7CT; 1x1-76/42, 1x2-12.7
PGR	pr. 191	1		BK-166	1947		57t, 25.9x4.3x0.7m, 2d, 1200hp, 16kts, 14p; 14belt, 10deck, 30turret, 14CT; 1x1-85/55, 2x2-12.7
	pr. 191M	118?		?BK-167-174, 439-444, 446, 447, 451-454, 459-462, 464-466, 468, 475-481, 486, ...	1948 - 1952		57t, 26.0x4.4x0.7m, 2d, 2000hp, 20.8kts, 15p; 14belt, 10deck, 30turret, 14CT; 1x1-85/55, 2x2-14.5, 8mines
	pr. 192	2		BK-472, 473	1951		65t, 27.5x4.4x0.7m, 2d, 2000hp, 22.8kts, 15p; 18belt, 10deck, 30turret, 24CT; 1x1-85/55, 2x2-14.5, 8mines

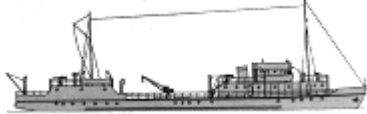
MINE WARFARE SHIPS

NL	pr. 149	4	1	Viatka	1941		527t, 56.8x9.8x1.7m, 3d, 330hp, 8.3kts, 54p; 3x1-45/46, 2x1-12.7(1,2), 1x4-12.7(3,4), 50mines, nets
			2	Onega	1941		
			3	Mologa	1944		
			4	Sukhona	1944		
			1	T-701	1945		

M1940	3	3	T-704	1942		775t, 62.3x8.9x2.3m, 2b,2vteet, 2615hp, 17.2kts, 75p; 2x1-105/45, 2x1-37/83, (1x4+2x1)-20/65, 4dct, 2dcr, 12mines, sweeps
		4	T-705	1944		
pr. 254	47	91	T-44	1949		569t, 58.0x8.5x2.3m, 2d, 2200hp, 14kts, 65p; 2x2-37/70, 4x2-12.7, 2dct, 2dcr, 16mines, mechanical, magnetic, acoustic sweeps; Rif, Rym-K radars, Tamir-10 sonar
		93	T-46	1949		
		106	T-48	1949		
		110	T-91	1950		
		111	T-92	1949		
		113	Aleksandr Nikolaev	1950		
		114	T-95	1950		
		115	T-96	1950		
		116	T-97	1950		
		117	T-98	1950		
		118	T-99	1950		
		119	T-102	1950		
		120	T-103	1950		
		121	T-104	1950		
		122	T-105	1950		
		125	T-109	1951		
		126	T-131	1951		
		127	T-132	1951		
		128	T-133	1951		
		129	T-134	1951		
		130	T-135	1951		
		131	T-136	1951		
		132	T-137	1951		
		133	T-138	1951		
		134	T-139	1951		
		135	T-140	1952		
		136	T-141	1952		
102	T-51	1950				
103	T-52	1950				
105	Ivan Maslov	1951				
106	T-54	1951				
107	T-55	1951				
108	T-56	1951				
109	T-57	1951				
110	T-59	1951				
111	T-60	1951				

112	T-61	1951
114	Boris Safonov	1952
115	T-64	1952
116	T-65	1952
117	Vsevolod Vishnevskiy	1952
118	T-66	1952
119	T-67	1952
120	T-68	1952
121	T-69	1953
122	T-74	1954
124	T-76	1953
143	T-419	1952
145	T-421	1952
147	T-423	1953
148	T-425	1953
150	T-427	1953
151	T-428	1953
152	T-429	1953
153	T-430	1953
157	T-480	1953
158	T-481	1953
161	T-484	1953
162	T-485	1953
163	T-486	1953
164	T-487	1954
165	T-488	1954
166	T-489	1954
167	T-490	1954
168	T-491	1954
169	T-492	1954
170	T-493	1954
171	T-494	1954
172	T-495	1954
178	T-502	1954
179	T-503	1954
180	T-504	1955
126	T-79	1953
128	T-81	1953
130	T-84	1953
133	T-88	1954

MSO

pr. 254K 47









577t, 58.0x8.5x2.3m, 2d, 2200hp, 14kts, 68p; 2x2-37/70, 4x2-12.7, 2dct, 2dcr, 16mines, mechanical, magnetic, acoustic sweeps; Lin', Rym-K radars, Tamir-10 sonar



134	T-89	1954
135	T-801	1954
136	T-802	1954
139	T-805	1954
140	T-806	1954
143	T-809	1954
13	T-810	1954
16	T-811	1954
31	T-815	1955
38	T-816	1955
46	T-817	1955
47	T-822	1955
51	T-823	1955
55	T-818	1955
56	T-824	1955
65	T-819	1955
69	T-826	1955
77	T-827	1955
912	T-505	1955
913	T-506	1955
914	T-507	1955
915	T-508	1955
711	T-509	1955
714	T-512	1955
511	T-519	1955
512	T-520	1955
514	T-518	1955
515	T-457	1955
811	T-458	1955
813	T-529	1956
814	T-528	1956
923	T-530	1956
924	T-831	1956
925	T-832	1956
721	T-833	1956
722	T-834	1956
723	T-835	1957
724	T-836	1957
725	T-837	1957
521	T-838	1957
522	T-839	1957

pr. 254M 26



600t, 59.1x8.5x2.3m, 2d, 2200hp, 14.5kts, 77p; 2x2-37/70, 2x2-25/112, 2x2-14.5, 2x2-12.7, 2dct, 16mines, mechanical, magnetic, acoustic sweeps; Lin', Rym-K radars, Tamir-11 sonar

		523	T-840	1957		
		524	T-747	1957		
		525	T-748	1957		
pr. 254A	7	821	T-749	1957		615t, 59.1x8.5x2.4m, 2d, 2200hp, 15kts, 75p; 2x1-45/89, 2x2-14.5, 2dct, 16mines, mechanical, magnetic, acoustic sweeps; Lin', Rym-K radars, Tamir-11 sonar
		822	T-750	1957		
		823	T-751	1957		
		824	T-6	1958		
		825	T-7	1958		
		826	T-129	1958		
		827	T-130	1958		
pr. 264	1	815	T-250	1958		840t, 69.8x9.6x2.5m, 2d, 4000hp, 17.6kts, 88p; 2x2-57/75, 2x2-25/112, 1x24 MBU-600 ASWRL, 2dcr, 38mines, mechanical, magnetic, acoustic sweeps; Rym-K, Lin'-M, Don radars, Tamir-11 sonar, Bizan'-4 ECM
pr. 264A	8	930	T-9	1958		868t, 69.8x9.6x2.6m, 2d, 4000hp, 17kts, 89p; 2x2-57/75, 2x2-25/112, 2x5 RBU-2500 ASWRL, 2dcr, 38mines, mechanical, magnetic, acoustic sweeps; Rym-K, MR-103 Bars, Lin'-M, Don radars, Tamir-11M sonar, Bizan'-4 ECM, BOKA decoy
		931	T-161	1959		
		932	T-14	1959		
		933	T-15	1959		
		934	T-22	1959		
		937	T-4	1959		
		941	T-5	1959		
		942	Vasiliy Gromov	1959		
pr. 53U	6	19	Gak	1939		480t, 62.0x7.4x2.2m, 2d, 2900hp, 18.2kts, 47p; 1x1-100/56, 1x1-45/46(19,20,24,35,36), 1x1-37/73(28), 2x1-20/70(19,20,24,25), 2x1-12.7(19,20,24,28,35,36), 2dcr, 31mines, sweeps
		20	Rym	1940		
		24	T-215	1940		
		28	Kontr-admiral Yurkovskiy	1941		
		35	T-220	1946		
		36	Dmitriy Lysov	1946		
MMS1001	4	3	T-193	1945		430t, 42.7x8.5x3.2m, 1d, 500hp, 10kts, 21p; 2x2-20/70, sweeps
		7	T-197	1945		
		10	T-200	1946		
		12	T-202	1946		
pr. 265	2	1	T-17	1954		259t, 44.6x5.9x1.8m, 2d(vs), 1800hp, 15.5kts, 47p; 1x2-37/70, 2x2-14.5, 1dct, 6mines, mechanical, magnetic, acoustic sweeps; Don radar, Tamir-11 sonar, Bizan'-4 ECM
		2	T-19	1954		
MSC		1	T-23	1957/59		
		2	T-24	1957/59		
		3	T-25	1957/59		
		4	T-150	1957/59		
		5	T-152	1957/59		

pr. 265K	13	6	T-153	1957/59		289t, 46.1x6.4x1.9m, 2d(vs), 1800hp, 15kts, 47p; 1x1-45/89, 2x2-25/112, 1dct, 6mines, mechanical, magnetic, acoustic sweeps; Don radar, Tamir-11 sonar, Bizan'-4 ECM				
		7	T-157	1957/59						
		8	T-158	1957/59						
		9	T-164	1957/59						
		10	T-165	1957/59						
		11	T-166	1957/59						
		12	T-167	1957/59						
		13	T-234	1957/59						
		pr. 265A	6	1			T-2	1959		315t, 46.5x6.6x1.9m, 2d(vs), 2000hp, 14.5kts, 47p; 1x1-57/81, 2x2-25/112, 1dct, mechanical, magnetic, acoustic sweeps; Don radar, MG-11-265A sonar, Bizan'-4 ECM
				2			T-3	1959		
				3			T-162	1959		
				4			T-172	1959		
				5			T-251	1959		
6	T-286			1959						
pr. 255	11	1	T-310	1948		160t, 38.0x5.7x1.6m, 3d, 480hp, 10kts, 35p; 2x1-45/68, 2x1-12.7, 2dcr, mechanical, magnetic, acoustic sweeps; Tamir-10 sonar				
		2	T-229	1948/49						
		3	T-230	1948/49						
		4	T-301	1948/49						
		5	T-302	1948/49						
		6	T-303	1948/49						
		7	T-304	1948/49						
		8	T-305	1948/49						
		9	T-306	1948/49						
		10	T-307	1948/49						
		11	T-308	1948/50						
		1	T-309	1951/53						
		2	T-310	1951/53						
		3	T-311	1951/53						
		4	T-312	1951/53						
		5	T-313	1951/53						
		6	T-314	1951/53						
		7	T-315	1951/53						
		8	T-316	1951/53						
		9	T-322	1951/53						
		10	T-327	1951/53						
		11	T-328	1951/53						
		12	T-340	1951/53						
		13	T-341	1951/53						
		14	T-342	1951/53						
		15	T-343	1951/53						



16	T-344	1951/53
17	T-345	1951/53
18	T-346	1951/53
19	T-347	1951/53
20	T-348	1951/53
21	T-349	1951/53
22	T-350	1951/53
23	T-392	1951/53
24	T-393	1951/53
25	T-394	1951/53
26	T-395	1951/53
27	T-396	1951/53
28	T-397	1951/53
29	T-398	1951/53
30	T-399	1951/53
31	T-400	1951/53
32	T-436	1951/53
33	T-437	1951/53
34	T-438	1951/53
35	T-442	1951/53
36	T-443	1951/53
37	T-444	1951/53
38	T-445	1951/53
39	T-446	1951/53
40	T-447	1951/53
41	T-448	1951/53
42	T-449	1951/53
43	T-450	1951/53
44	T-451	1951/53
45	T-452	1951/53
46	T-453	1951/53
47	T-454	1951/53
48	T-455	1951/53
49	T-456	1951/53
50	T-528	1951/53
51	T-529	1951/53
52	T-530	1951/53
53	T-531	1951/53
54	T-532	1951/53
55	T-533	1951/53
56	T-551	1951/53

pr. 255K 124

57	T-552	1951/53
58	T-553	1951/53
61	T-564	1951/53
62	T-565	1951/53
65	T-574	1951/53
66	T-587	1951/53
67	T-622	1951/53
68	T-632	1951/53
69	T-642	1951/53
70	T-651	1951/53
71	T-652	1951/53
72	T-653	1951/53
73	T-654	1951/53
74	T-655	1951/53
75	T-726	1951/53
76	T-731	1951/53
77	T-741	1951/53
78	T-742	1951/53
79	T-743	1951/53
80	T-744	1951/53
81	T-745	1951/53
82	T-746	1951/53
83	T-...	1951/53
84	T-...	1951/53
85	T-...	1951/53
86	T-...	1951/53
87	T-...	1951/53
88	T-...	1951/53
89	T-...	1951/53
90	T-...	1951/53
91	T-...	1951/53
92	T-...	1951/53
93	T-...	1951/53
94	T-...	1951/53
95	T-...	1951/53
96	T-...	1951/53
97	T-...	1951/53
98	T-...	1951/53
99	T-...	1951/53
100	T-...	1951/53







161t, 38.0x5.7x1.6m, 3d, 690hp, 12kts, 37p; 2x1-45/68, 2x1-12.7, 2dcr, mechanical, magnetic, acoustic sweeps; Tamir-10 sonar

			101	T-...	1951/53		
			102	T-...	1951/53		
			103	T-...	1951/53		
			104	T-...	1951/53		
			105	T-...	1951/53		
			106	T-...	1951/53		
			107	T-...	1951/53		
			108	T-...	1951/53		
			109	T-...	1951/53		
			110	T-...	1951/53		
			111	T-...	1951/53		
			112	T-...	1951/53		
			113	T-...	1951/53		
			114	T-...	1951/53		
			115	T-...	1951/53		
			116	T-...	1951/53		
			117	T-...	1951/53		
			118	T-...	1951/53		
			119	T-...	1951/53		
			120	T-...	1951/53		
			121	T-...	1951/53		
			122	T-...	1951/53		
			123	T-...	1951/53		
			124	T-...	1951/53		
MSB	pr. T351	1		KT-...	1950	No picture	11t, 10.2x2.4x0.7m, 1d, 150hp, 8.2kts, 7p; mechanical sweep
	pr. T361	100?		KT-...	1951 - 1959		20t, 15.8x3.4x0.9m, 2d, 300hp, 11.6kts, 9p; 1x2-14.5, mechanical or magnetic or acoustic sweep
MSR	pr. 151	64?		T-...	1954 - 1959		51t, 27.7x4.0x0.7m, 2d, 300hp, 12kts, 16p; 2x2-25/112, 2dcr or 25mines, mechanical, magnetic, acoustic sweeps
AMS	pr. T388	1		T-...	1950s		207t

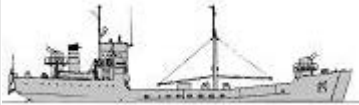

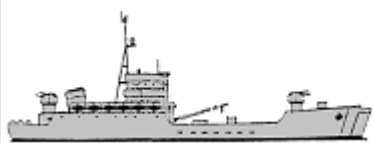

AMPHIBIOUS

LSM	pr. 188	4	701	TDK-8	1958		1460t, 74.6x11.3x2.4m, 2d, 4000hp, 14.2kts, 66p; 2x2-57/75; 5tanks, 82troops; Neptun radar, BOKA decoy
			702	TDK-9	1959		
			703	TDK-11	1959		
			704	TDK-12	1959		
			1	DK-17	1951?		
			2	DK-23	1951?		
			3	DK-41	1951?		
			4	DK-46	1951?		

LCU	pr. 450	25?	5	DK-47	1951?		660t, 52.4x8.2x2.2m, 2d, 600hp, 9.5kts, 28p; 2x2-25/112; 3tanks; Neptun radar				
			6	DK-48	1952						
			7	DK-49	1952?						
			8	DK-50	1952?						
			9	DK-52	1952?						
			10	DK-53	1952?						
			11	DK-114	1954						
			12	DK-115	1954						
			13	DK-116	1953?						
			14	DK-122	1953?						
			15	DK-123	1953?						
			16	DK-124	1954?						
			17	DK-130	1954?						
			18	DK-133	1954?						
			19	DK-144	1954?						
			20	DK-145	1954?						
			21	DK-147	1955?						
			22	DK-148	1955?						
			23	DK-149	1955?						
			24	DK-150	1955?						
			25	DK-152	1955?						
			pr. 450bis	13?	1			DK-128	1955?		716t, 52.5x8.2x2.5m, 2d, 900hp, 10.1kts, 28p; 2x2-25/112; 3tanks; Neptun radar
					2			DK-131	1955?		
					3			DK-132	1955?		
					4			DK-134	1956?		
5	DK-135	1956?									
6	DK-136	1956?									
7	DK-142	1956?									
8	DK-143	1956?									
9	DK-146	1956									
10	DK-151	1957?									
11	DK-118	1957									
12	DK-126	1957									
13	DK-31	1957									
pr. 189	6	1	DK-251	1956		494t, 57.2x7.7x2.2m, 2d, 2200hp, 15.1kts, 51p; 3x2-25/112; 5AFV or 162troops					
		2	DK-252	1956							
		3	DK-253	1956							
		4	DK-15	1957							
		5	DK-16	1957							
		6	DK-43	1957							

LC	pr. 306	100?		T...	1955 - 1959		70t, 17.0x4.3x1.0m, 1d, 230hp, 8kts, 3p; 1tank or 20troops
	pr. A-3	100?		T...	1957 - 1959	No picture	1tank

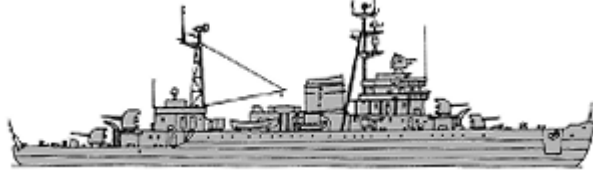
BOARD GUARD

PS	pr. 254	2	123	Zhemchug	1951		569t, 58.0x8.5x2.3m, 2d, 2200hp, 14kts, 65p; 2x2-37/70, 4x2-12.7, 2dct, 2dcr; Rif, Rym-K radars, Tamir-10 sonar
			124	Brilliant	1951		
	pr. 254K	7	138	Izumrud	1952		577t, 58.0x8.5x2.3m, 2d, 2200hp, 14kts, 68p; 2x2-37/70, 4x2-12.7, 2dct, 2dcr; Lin', Rym-K radars, Tamir-10 sonar
			140	Topaz	1952		
			142	Almaz	1952		
			155	Yantar'	1953		
			156	Agat	1953		
			131	Sapfir	1953		
	pr. 254MA	3	828	Opal	1958		600t, 59.1x8.5x2.3m, 2d, 2200hp, 14.5kts, 77p; 2x2-37/70, 2x2-25/112, 2x2-14.5, 2x2-12.7, 2dct; Lin', Rym-K radars, Tamir-11 sonar
			829	Korall	1958		
			830	Khrustal	1958		
	pr. 52	1	116/630	Purga	1957		3958t, 95.5x15.1x5.7m, 6dg,3em, 12000hp, 17kts, 250p; 4x1-100/56, 6x2-37/70, 4dct, 30mines; Rif, Rym-1 radars, Tamir-5 sonar
	pr. 264A	2	935	Dzerzhinskiy	1959		868t, 69.8x9.6x2.6m, 2d, 4000hp, 17kts, 89p; 2x2-57/75, 2x2-25/112, 2x5 RBU-2500 ASWRL, 2dcr; Rym-K, MR-103 Bars, Lin'-M, Don radars, Tamir-11M sonar, Bizan'-4 ECM, BOKA decoy
			936	Menzhinskiy	1959		
				436	PSKR-409	1948	
			441	PSKR-410	1948		
			444	PSKR-411	1948		
			452	PSKR-401	1949		
			453	PSKR-402	1949		
			461	PSKR-412	1949		
			465	PSKR-422	1949		
			466	PSKR-428	1949		
			474	PSKR-413	1950		
			475	PSKR-403	1950		
			476	PSKR-433	1950		
			483	PSKR-434	1950		
			485	PSKR-435	1950		

PC pr.
122bis 56

497	PSKR-404	1951
498	PSKR-405	1951
527	PSKR-414	1952
528	PSKR-415	1952
529	PSKR-416	1952
530	PSKR-406	1952
533	PSKR-438	1952
536	PSKR-439	1952
537	PSKR-440	1952
538	PSKR-441	1952
548	PSKR-452	1952
551	PSKR-453	1952
552	PSKR-454	1952
553	PSKR-455	1952
565	PSKR-442	1953
566	PSKR-417	1953
567	PSKR-429	1953
568	PSKR-423	1953
569	PSKR-443	1953
584	PSKR-459	1953
586	PSKR-457	1953
589	PSKR-458	1953
591	PSKR-456	1953
903	PSKR-439	1955
908	PSKR-431	1955
912	PSKR-432	1955
814	PSKR-444	1954
815	PSKR-445	1954
816	PSKR-446	1954
817	PSKR-447	1954
818	PSKR-448	1954
819	PSKR-449	1954
820	PSKR-450	1954
821	PSKR-451	1954
822	PSKR-436	1954
823	PSKR-437	1954
918	PSKR-424	1955
920	PPSKR-418	1955
921	PSKR-407	1955
925	PSKR-408	1955





325t, 51.7x6.6x2.2m, 3d, 3600hp, 20kts, 54p; 1x1-85/52, 2x1-37/73, 2x2-12.7, 2x5 RBU-1200 ASWRL, 1dcr, 18mines; Lin' or Neptun radar, Tamir-10 or Tamir-11 sonar

			926	PSKR-419	1955		
			930	PSKR-425	1955		
			931	PSKR-426	1955		
PB	SC	3	1	BO-320	1943		136t, 33.8x5.5x2.0m, 2d, 2400hp, 21kts, 33p; 1x1-40/60, 3x1-20/70, 2x4-178 Mousetrap ASWRL, 2dct, 2dcr; SU radar, QC sonar
			2	BO-328	1943		
			3	BO-332	1943		
	pr. 183	11		PSKR-100,107,113,114,119,123,125,127,128,132,136	1949		67t, 25.5x6.2x1.2m, 4d, 4800hp, 43kts, 14p; 2x2-25/112, 2-533TT, 8dc; Zarnitsa radar
	pr. 201M	10	1	PSKR-201	1958/59		216t, 41.7x6.2x1.9m, 3d, 6600hp, 25kts, 27p; 2x2-25/112, 4x5 RBU-1200 ASWRL, 2dcr, 18mines; Reya radar, Tamir-11 sonar
			2	PSKR-202	1958/59		
			3	PSKR-203	1958/59		
			4	PSKR-233	1958/59		
			5	PSKR-234	1958/59		
			6	PSKR-235	1958/59		
			7	PSKR-236	1958/59		
			8	PSKR-237	1958/59		
			9	PSKR-238	1958/59		
			10	PSKR-257	1958/59		
	pr. 199	64		PSKR-301-303, 314-351, 544-556	1955 - 1959		83t, 25.5x6.2x1.5m, 4d, 4800hp, 35kts, 23p; 2x2-25/112, 2dct, 2dcr; Zarnitsa radar, Tamir-11 sonar
pr. P368	30?		PSKA-500...	1954 - 1959		93t, 29.9x6.0x1.5m, 2d, 2200hp, 21kts, 14p; 1x2-14.5; Stvor radar	



[home](#)[World navies yesterday](#)[1960](#)

Spain 01 January 1960

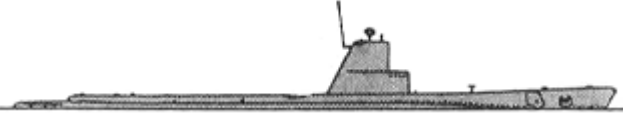

SUBMARINES

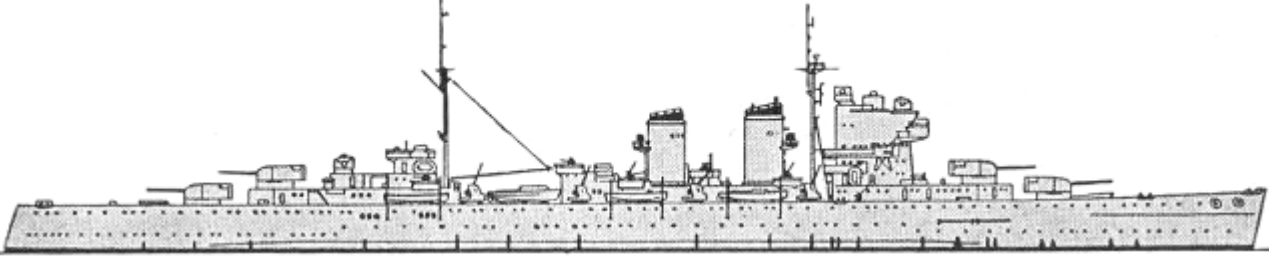
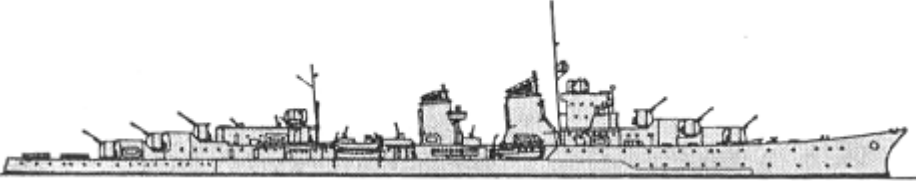
	D1	3	S11	D1	1947		1065/1399t, 84.3x6.7x4.3m, 2d/em, 5000/1350hp, 20.5/9.5kts, 56p, 60m; 1x1-88/45, 1x1-20/65, 6-533TT
			S21	D2	1951		
			S22	D3	1954		
SS	G1	1	S01	G7	1941		769/1070t, 67.1x6.2x4.7m, 2d/em, 2800/750hp, 17/7.6kts, 54p, 100m; 1x1-88/45, 5-533TT
	Balao	1	S31	Almirante García de los Reyes	1944		1830/2440t, 95.0x8.3x5.2m, 4dg,4em(2), 4610/2700hp, 20/10kts, 82p, 120m; 10-533TT; SS, ST, SV radars, BQR-2, BQS-2, SQR-3 sonars
SSX	Foca	2	F1, 2	Foca I, Foca II	1957	No picture	16/20t, 13.9x1.8x1.5m, 1d/em, 160/110hp, 9.2/12kts, 3p, 120m; 2-533TT
	Tiburón	2	T1, 2	Tiburón I, Tiburón II	1958	No picture	78/81t, 21.5x2.7x2.7m, 2d/2em(1), 400/400hp, 10/14.5kts, 8p, 120m; 2-533TT



PRINCIPAL SURFACE COMBATANTS

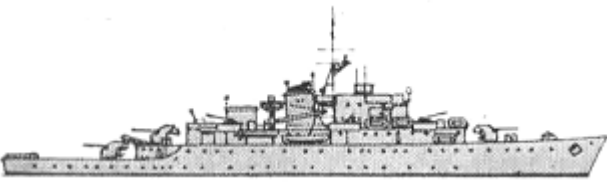
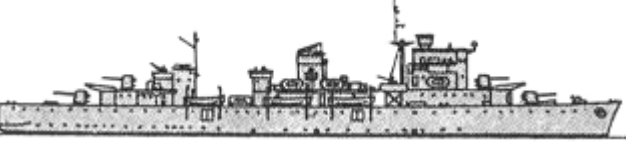
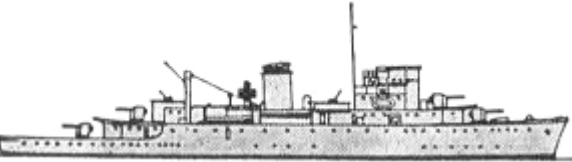



CA	Canarias	1	C21	Canarias	1936		13750t, 193.6x19.5x5.3m, 8b,4gst, 90000hp, 33kts, 1200p; 51belt, 37deck, 25turrets, 25CT; 4x2-203/50, 8x1-120/45, 4x1-40/70, 4x2-37/83, 4x1-20/70, 2dct, 1dcr; SG-6B, MLA-1B, Marconi, Decca 12 radars
	Méndez Núñez	1	C01	Méndez Núñez	1924		6045t, 142.9x14.1x4.4m, 12b,4gst, 45000hp, 29kts, 343p; 76belt, 25deck, 150CT; 8x1-120/45, 4x2-37/83, 7x1-20/70, 4x4-20/65, 2x3-533TT, 2dct, 1dcr
CL	Príncipe Alfonso	3	C11	Galicia	1925		9748(11,13)-9660(12)t, 176.6x16.5x5.0m, 8b,4gst, 80000hp, 31.5(11,13)-33(12)kts, 781(11,13)-564(12)p; 76belt, 50deck, 13shields, 150CT; 4x2-152/50(11,13), (3x2+2x1)-152/50(12),
			C12	Almirante Cervera	1927		
				Miguel de			

						8x2-37/83, 5x4-20/65(11,13), 4x1-20/65(12), 4dct(11,13), 1seaplane(He114)(13)	
	Alsedo	1	1	Lazaga	1925		1337t, 86.8x8.2x4.5m, 4b,2gst, 33000hp, 34kts, 86p; 3x1-102/50, 3x1-20/65, 2x2-450TT, 2dct, 1dcr, 60mines
	Churucca	3	D11	Sánchez Barcáiztegui	1928		2087t, 102.0x9.7x3.2m, 4b,2gst, 42000hp, 36kts, 190p; 4x1-120/45, 2x2-37/83, 4x1-20/65, 2x3-533TT, 2dcr
D12			José Luis Díez	1929			
D13			Churucca	1931			
	Almirante Antequera	5	D14	Almirante Antequera	1935		2175t, 101.2x9.7x3.2m, 4b,2gst, 42000hp, 36kts, 190p; 4x1-120/45, 2x2-37/83, 4x1-20/65, 2x3-533TT, 2dct, 2dcr
D15			Almirante Miranda	1936			
D16			Gravina	1936			
D17			Escaño	1936			
D18			Ulloa	1937			
	Álava	2	D21	Liniers	1951		2225t, 101.1x9.7x3.7m, 4b,2gst, 42000hp, 36kts, 204p; 4x1-120/45, 2x1-37/83, 3x1-20/65, 2x3-533TT, 2dct, 1dcr
			D23	Álava	1951		
	Audaz	4	D31	Audaz	1953		1548t, 93.9x9.5x3.4m, 3b,2gst, 30800hp, 31.6kts, 199p; 2x1-76/50, 2x1-40/70, 2-324TR, 2x24-178 Hedgehog ASWRL, 8dct, 2dcr; SPS-5B, MLA-1B, Mk63 radars, QHBa sonar
			D32	Osado	1955		
			D33	Meteoro	1955		
			D35	Rayo	1956		
	Fletcher	3	D21	Lepanto	1943		3005t, 114.7x12.1x4.2m, 4b,2gst, 60000hp, 38kts, 290p; 5x1-127/38(21,22), 4x1-127/38(23), 3x2-76/50(23), 3x2-40/60(21,22), 6x1-20/70(21,22), 1x3-533TT(23), 2x3-324TT, 2x24-178 Hedgehog ASWRL, 6dct(21,22), 4dct(23), 2dcr(21,22), 1dcr(23); SPS-6C, SPS-10, Mk25, 2x SPG-34(23), Mk35(23) radars, SQS-4 or SQS-29 sonar
			D22	Almirante Ferrándiz	1943		
			D23	Almirante Valdéz	1942		
			F31	Pizarro	1946		
			F32	Hernán Cortés	1947		
			F33	Vasco Núñez de Balboa	1947		
			F34	Martín Alonso	1948		



FF	Pizarro	8		Pinzón			2246t, 95.2x12.2x3.4m, 2b,2gst, 6000hp, 18.5kts, 251p; 3x2-120/50, 4x2-37/83, 6x1-20/65, 4dct, 1dcr, 30mines
			F35	Magallanes	1948		
			F36	Sarmiento de Gamboa	1950		
			F41	Vicente Yáñez Pinzón	1949		
		F42	Legazpi	1951			
	Júpiter	4	F01	Marte	1938		2600t, 96.0x12.7x3.5m, 4b,2gst, 10000hp, 18.5kts, 180p; 4x1-120/45, 2x1-76/40(01,03,04), 3x1-37/83(01), 2x2-37/83(02), 2x1-20/65(01), 3x1-20/65(02-04), 264mines, 2dct(01,02), 2dcr(03,04); MLA-1B(01), SG-6B(01) radars
			F02	Neptuno	1939		
			F03	Júpiter	1937		
F04			Vulcano	1937			
Eolo	2	F21	Eolo	1941		1925t, 88.9x11.8x3.7m, 2b,2gst, 5000hp, 19.5kts, 220p; 4x1-105/44, 2x2-37/83, 4x1-20/65, 2dct, 70mines	
		F22	Tritón	1943			
FS	Atrevida	4	F51	Descubierta	1955		1135t, 75.5x10.2x2.7m, 2d, 3000hp, 18.5kts, 132p; 1x1-76/50, 3x1-40/70, 2x24-178 Hedgehog ASWRL, 8dct, 2dcr; SPS-5B radar, QHBa sonar
			F61	Atrevida	1954		
			F62	Princesa	1959		
			F64	Nautilus	1959		

PATROL AND COASTAL COMBATANTS



Mersey	3	1	Uad Kert	1917		665t, 45.1x7.2x2.8m, 1b,1vte, 600hp, 11kts, 45p; 1x1-76/50(1,3), 2x1-76/50(2), 1x1-47/50(3)
		2	Arcíla	1918		
		3	Xauen	1918		
Lanzón	2	V17		1935	No picture	111t, 26.5x5.4x3.1m, 1pe, 285hp, 12kts
		V18		1935		
Pegaso	2	W21	Pegaso	1951		498t, 42.0x8.2x2.9m, 1vte, 532hp, 12kts, 39p; 1x1-76/50, 2x1-20/70
		W22	Procyon	1951		
Cíes	2	W31	Cíes	1948	No picture	275t, 31.0x6.1x2.5m, 1d, 400hp, 12kts, 31p; 1x1-20/70; RM914 radar
		W32	Sálvora	1948		
Centinela	2	W33	Centinela	1953	No picture	282t, 35.8x6.9x3.0m, 1d, 430hp, 12kts; 2x1-37/83; radar
		W34	Serviola	1953		
PC	1	1	Javier Quiroga	1943		463t, 52.9x7.1x3.3m, 2d, 2880hp, 19kts, 65p; 1x1-76/50, 1x1-40/60; SO radar
PR	Cabo	1	1	Cabo Fradera	1928	45t, 22.8x4.4x1.2m, 2pe, 121hp, 10.7kts, 16p; 1x1-42/42

	Fradera						
PT	LT27	6	LT27		1953		116t, 34.8x5.1x1.5m, 3d, 7500hp, 40kts, 22p; 2x1-20/65, 2-533TT, 2dcr; RM914 radar
			LT28		1953		
			LT29		1953		
			LT30		1953		
			LT31		1956		
			LT32		1959		
PB	V20	2	V20, 21		1942 - 1944		60t, 26.2x4.7x1.4m, 2d, 700hp, 18kts, 14p; 2x1-20/65
	C.I	18	1-18	C1, 3, 4, 6-16, 18-21	1922 - 1925	No picture	36t, 22.8x4.0x1.4m, 2d, 180hp, 12kts, 6p
	SC	1	W11	Cándido Pérez	1942		138t, 33.8x5.5x2.0m, 2d, 1000hp, 15.6kts, 27p; 1x1-40/60, 3x1-20/70, 2x4-178 Mousetrap ASWRL, 2dct, 2dcr; SCR-517A radar, QC sonar

AMPHIBIOUS

LCU	LCT(4)	2	K1	BDK1	1944		640t, 57.1x11.8x1.4m, 2d, 920hp, 10kts, 12p; 2x1-20/70, 9tanks or 200troops
			K2	BDK2	1945		
	BDK3	3	K3	BDK3	1959		902t, 56.6x11.6x1.7m, 2d, 1000hp, 8.5kts, 20p; 2x1-20/70; 400troops
			K4	BDK4	1959		
			K5	BDK5	1959		

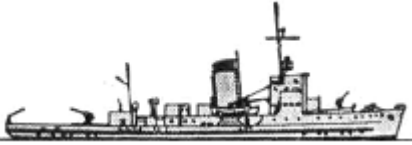
MINE WARFARE

MSO	Bidasoa	6	M01	Bidasoa	1946		748t, 61.9x8.5x2.6m, 2b,2vte, 2400hp, 16.5kts, 90p; 1x1-88/45 or 1x1-102/45, 1x1-37/83, 2x1-20/65, 2dcr, sweeps
			M02	Nervión	1946		
			M03	Lérez	1947		
			M04	Tambre	1946		
			M05	Segura	1949		
			M06	Ter	1948		
	Guadiaro	7	M11	Guadiaro	1953		770t, 74.3x10.2x3.7m, 2b,2vte, 2400hp, 16kts, 79p; 1x1-88/45(13-17), 1x1-37/83(13-17), 2x1-20/65, 2dcr, sweeps; RM914 radar, UQS-1 sonar
			M12	Tinto	1953		
			M13	Eume	1953		
			M14	Almazorra	1954		
			M15	Navia	1955		
			M16	Guadalhorce	1953		
			M17	Eo	1955		
			M21	Nalón	1954		
			M22	Llobregat	1954		
			M23	Júcar	1956		

MSC	Nalón	12	M24	Ulla	1956
			M25	Miño	1956
			M26	Ebro	1958
			M27	Turia	1955
			M28	Duero	1955
			M29	Sil	1955
			M30	Tajo	1959
			M31	Genil	1959
			M32	Odiel	1959



400t, 44.3x8.1x2.1m, 2d, 880(21-25,27-29)-1000(26,30-32)hp, 12(21-25,27-29)-12.5(26,30-32)kts, 39p; 1x2-20/70, mechanical, acoustic, magnetic sweeps; RM914 radar, UQS-1 sonar



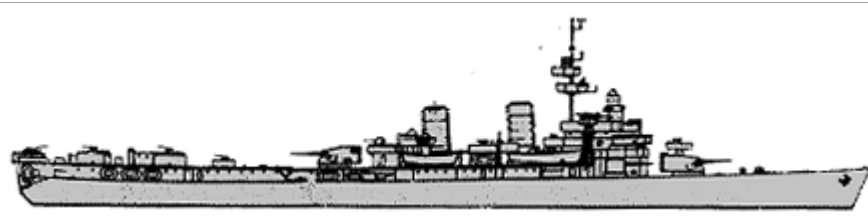
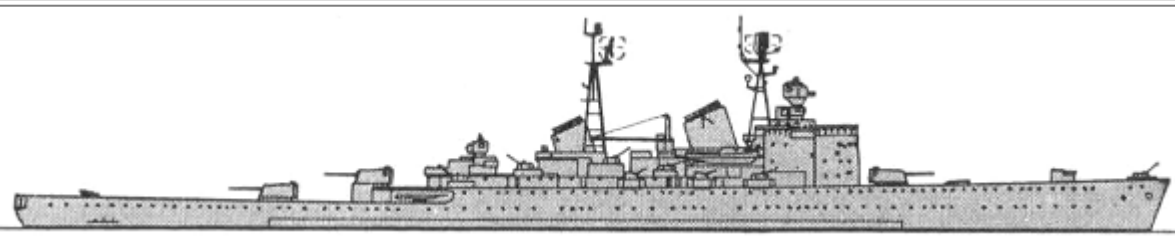
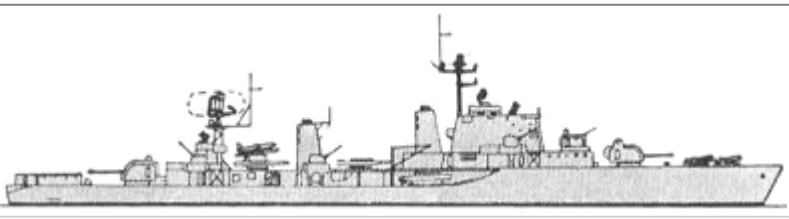
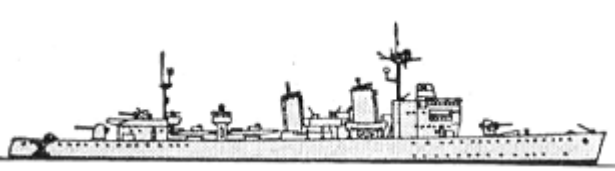
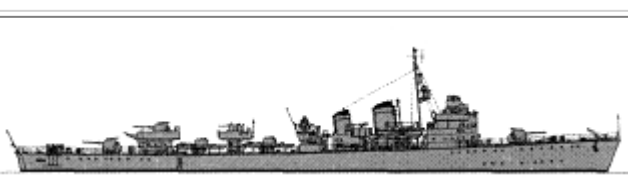
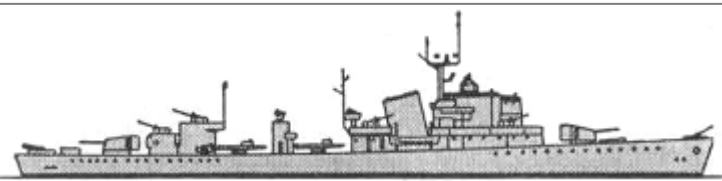
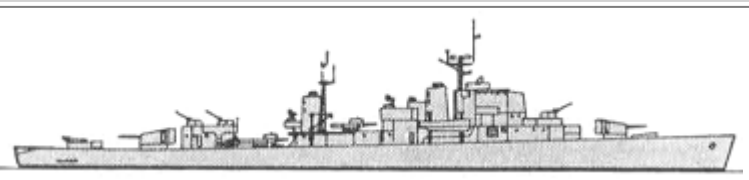
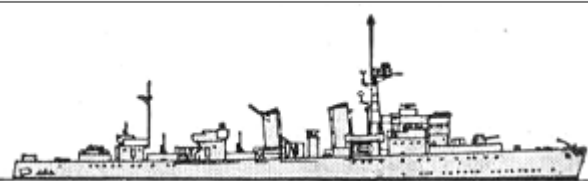

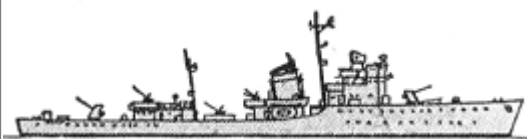

© Ivan Gogin, 2015

CL							
	Tre Kronor	2	1 Göta Lejon 2 Tre Kronor	1947 1947		9238t, 180.2x16.7x5.7m, 4b,2gst, 90000hp, 33kts, 783p; 90belt, 60decks, 125turrets, 20CT; (1x3+2x2)-152/53, 4x1-57/60, 11x1-40/70, 2x3-533TT, 120mines, 4dcr; LW-03, type 277, type 293, FC radars	
DDG	Halland	2	18	Halland	1955		3400t, 121.0x12.6x5.5m, 2b,2gst, 58000hp, 35kts, 290p; 1x2 Rb315 SSM (2 Rb315), 2x2-120/50, 1x2-57/60, 6x1-40/70, (1x5+1x3)-533TT, 2x4-375 M50 ASWRL, 2dcr, 58mines, 2x6-103RFL; Scanter 009, Saturn, M45 radars, sonar
			19	Småland	1956		
DD	Göteborg	5	6	Stockholm	1937		1250t, 94.6x9.7x3.8m, 3b,2gst, 32000hp, 39kts, 155p; 3x1-120/45, 2x2-40/70, 2x3-533TT, 2dct, 2dcr, 46mines; radar, sonar
			7	Malmö	1939		
			8	Karlskrona	1940		
			9	Gävle	1941		
			10	Norrköping	1941		
	Visby	4	11	Visby	1943		1320t, 98.0x9.0x3.8m, 3b,2gst, 32000hp, 39kts, 155p; 3x1-120/45, 3x1-40/70(13,14), (1x2+2x1)-40/60(11,12), 4x1-20/66(11,12), 2x3-533TT(11,12), 1x5-533TT(13,14), 2dct, 2dcr, 46mines; radar, sonar
			12	Sundsvall	1943		
			13	Hälsingborg	1943		
			14	Kalmar	1944		
	Öland	2	16	Öland	1947		2250t, 112.0x11.2x3.4m, 2b,2gst, 44000hp, 35kts, 210p; 2x2-120/45, 6x1-40/70(16), 7x1-40/60(17), 8x1-20/66(17), 2x3-533TT, 1x3-305 Squid ASWRL(16), 2dct, 2dcr, 40mines; Saturn, 2x M45 radars, sonar
			17	Uppland	1948		
	Östergötland	4	20	Östergötland	1958		2600t, 112.0x11.2x3.7m, 2b,2gst, 47000hp, 35kts, 244p; 2x2-120/50, 7x1-40/70, 1x6-533TT, 1x3-305 M51 Squid ASWRL, 60mines; Saturn, M45 radars, sonar
			21	Södermanland	1958		
			22	Gästrikland	1959		
23			Hälsingland	1959			
FF	Ehrensköld	2	71	Ehrensköld	1927		1160t, 91.4x8.9x3.8m, 3b,2gst, 24000hp, 36kts, 120p; 1x1-120/45, 2x2-40/60, 1x1-20/66, 8dct, radar, sonar
			72	Nordenskjöld	1927		
	Mode	4	73	Mode	1942		960t, 78.0x8.1x2.3m, 2b,2gst, 16000hp, 31kts, 100p; 2x1-105/50, 2x1-40/60, 2x1-20/66, 1x3-305 Squid ASWRL, 2dct, 42mines; radar, sonar
			74	Magne	1942		
			75	Munin	1943		

76 Mjölner 1942



PATROL AND COASTAL COMBATANTS





PC	-	2	J21	Granat	1935		440t, 1vte, 800hp, 10kts; 1x1-57/55	
			J22	Harpun	1925		440t, 1vte, 800hp, 10kts; 1x1-57/55	
PT	Plejad	11	T32	T32-41		1951-1953	 39t, 23.0x5.6x1.4m, 3pe, 4500hp, 45kts, 16p; 1x1-40/70, 2-533TT, 1x12-57RFL; radar	
			T101	T101	Perseus	1951	 160t, 48.0x5.8x1.6m, 3d, 7500hp, 37kts, 33p; 2x1-40/70, 4-533TT, 4x1-103RFL, 1x12-57RFL	
			T201	T201		1953	No picture	17t, 16.3x3.8x1.5m, 3pe, 4500hp, 44kts; 2-533TT
			T102	Plejad	1954		170t, 48.0x5.8x1.6m, 3d, 7500hp, 33kts, 33p; 2x1-40/70, 6-533TT, 4x1-103RFL, 1x12-57RFL; radar	
			T103	Polaris	1954			
			T104	Pollux	1954			
			T105	Regulus	1954			
			T106	Rigel	1954			
			T107	Aldebaran	1955			
			T108	Altair	1957			
			T109	Antares	1956			
			T110	Arcturus	1957			
			T111	Argo	1957			
T112	Astrea	1957						
T42	T42-56		1955-1957	 45t, 23.0x5.9x1.4m, 3pe, 4500hp, 45kts, 16p; 1x1-40/70, 2-533TT, 1x12-57RFL; Scanter 009 radar				
PB	V51	6	SVK1	SVK1-5		1944	No picture	19t, 16.5x3.7x1.2m, 1d, 100hp, 10.5kts, 12p; 1x1-20/66
			V51		1944		145t, 32.0x5.3x2.2m, 1b,1vte, 400hp, 11kts, 12p; 1x1-20/66	
			V52		1945			
			V53		1945			
			V54		1945			
			V55		1944			
			V56		1945			
V57	V57		1954	 135t, 32.5x5.3x2.3m, 1d, 500hp, 13.5kts, 17p; 1x1-20/66, mines				

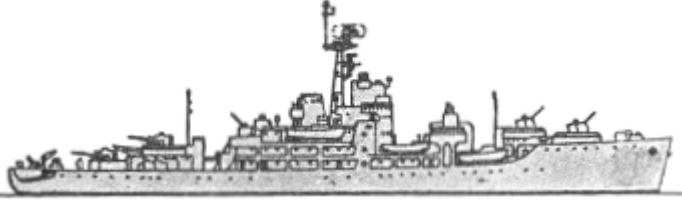

AMPHIBIOUS

LCU	Sleipner	1	A335	Sleipner	1959	No picture	335t, 36.0x8.6x2.6m, 2d, 640hp, 10kts; 2x1-12.7; 325troops; Terma radar
			J324	Ane	1943		

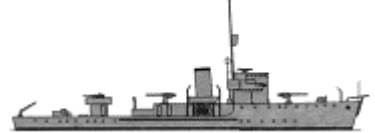
LCM	Ane	4	J325	Balder	1943	No picture	135t, 28.0x8.0x1.8m, 2d, 8.5kts; 1x1-20/66; troops
			J326	Loke	1943		
			J327	Ring	1945		
	L1	10	L11-15, 51-55		1949-1950	No picture	30t, 14.4x4.8xm, d, 8kts; troops
	SVK201	30	SVK201-230		1957-1959	No picture	31t, 21.4x4.2x1.3m, 3d, 600hp, 17kts; 1x1-20/70, 40troops or 40t of cargo

MINE WARFARE

ML	Mul10	1	Mul10	Mul10	1939	No picture	166t, 27.4x5.6x2.3m, 9.5kts; mines
	Älvsnabben	1	M01	Älvsnabben	1943		4250t, 102.0x13.6x4.9m, 1d, 3000hp, 14kts, 255p; 4x1-152/44, 4x2-40/60, 6x1-20/66, 4dcr, 380mines
	Mul11	1	Mul11	Mul11	1946	No picture	200t, 30.1x7.2x3.6m, 2d(1), 300hp, 10kts, 9p; 2x1-20/66, mines
	Mul12	8	Mul12	Mul12	1953		245t, 31.2x7.6x3.1m, 2dg,2em, 460hp, 10.5kts, 24p; 1x1-40/70, mines
		Mul13	Mul13	1953			
		Mul14	Mul14	1954			
		Mul15	Mul15	1954			
		Mul16	Mul16	1957			
MSC	Arholma	13	53	Arholma	1939		442t, 56.7x7.6x2.1m, 2b,2gst, 3200hp, 17kts, 37p; 2x1-105/41, 2x1-40/60, 2dct, mines, sweeps
			54	Landsort	1939		
			55	Bremön	1940		
			56	Holmön	1940		
			57	Sandön	1941		
			58	Ulvön	1941		
			59	Bredskär	1941		
			60	Grönskär	1941		
			61	Ramskär	1941		
			62	Örskär	1941		
			63	Koster	1940		
			64	Kullen	1941		
			65	Vinga	1940		
	Hanö	6	M51	Hanö	1953		295t, 40.0x7.0x2.4m, 2d, 910hp, 14.5kts, 25p; 2x1-40/70(51-55), 1x1-40/70(56), 1x6-57RFL, sweeps; radar
			M52	Tärnö	1953		
			M53	Tjurkö	1953		
			M54	Sturkö	1953		
			M55	Ornö	1953		



			M56	Utö	1953		
	Arkö	3	M57	Arkö	1958		300t, 44.0x7.0x2.4m, 2d, 1600hp, 14.5kts, 25p; 1x1-40/70, 1x6-57RFL, sweeps; radar
			M58	Spårö	1958		
			M59	Karlsö	1958		
MSI	M3	2	M9, 10		1940-1941	No picture	50t, 25.0x5.1x1.4m, 2d, 400hp, 13kts; 1x1-20/66, sweeps
	M15	12	M15-26		1941-1942		70t, 27.7x5.0x1.5m, 2d, 410hp, 13kts; 1x1-20/66, sweeps
	Orust	2	M41	Orust	1948	No picture	110t, 19.0x6.0x1.5m, 1d, 210hp, 9kts, 10p; 2x1-25/58, sweeps
			M42	Tjörn	1949		

© Ivan Gogin, 2015

[home](#)[World navies yesterday](#)[1960](#)

Syria 01 January 1960

PATROL AND COASTAL COMBATANTS

PT	pr. 123K	11	1-11		1951-1955		23t, 19.0x3.4x0.8m, 2d, 2000hp, 50kts, 7p; 1x2-14.5, 2-450TT, 2dcr; Zarnitsa radar
PB	Ch5	3	1	Akba Ben Naseh	1940		137t, 37.1x5.7x2.0m, 2d, 1130hp, 15.5kts, 28p; 2x1-20/70, 4dct, 1dcr
			2	Tarek Ben Said	1940		
			3	Abdullah Ibn Arissi	1946		

MINE WARFARE

MSO	pr. 254K	2	504	Yarmouk	1955		577t, 58.0x8.5x2.3m, 2d, 2200hp, 14kts, 68p; 2x2-37/70, 4x2-12.7, 2dct, 2dcr, 16mines, mechanical, magnetic, acoustic sweeps; Lin', Rym-K radars, Tamir-10 sonar
			505	Hitin	1955		

© Ivan Gogin, 2016

[home](#)[World navies yesterday](#)[1960](#)



Taiwan 01 January 1960

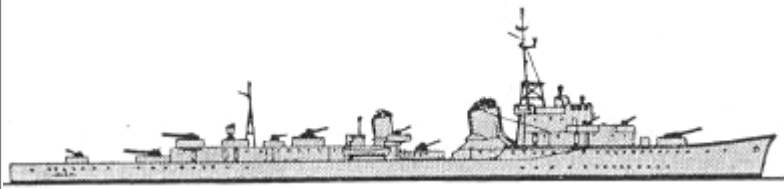
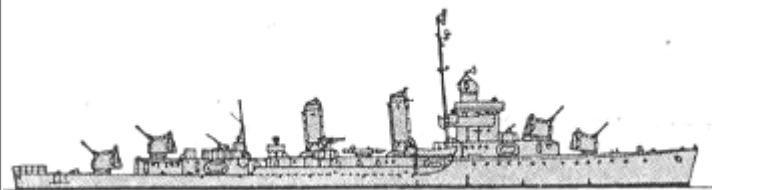
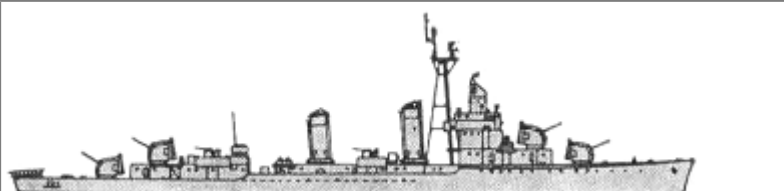
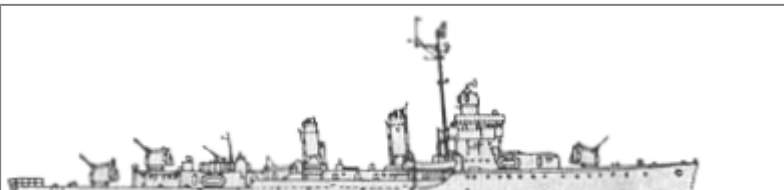
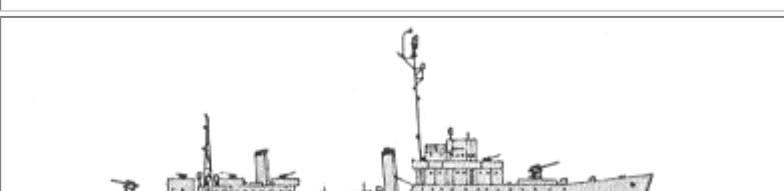
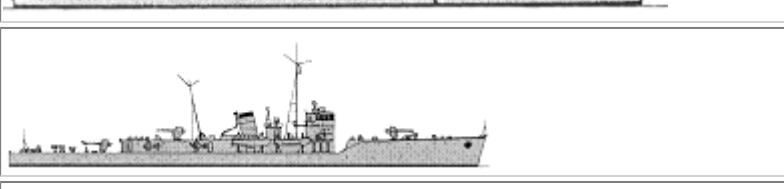

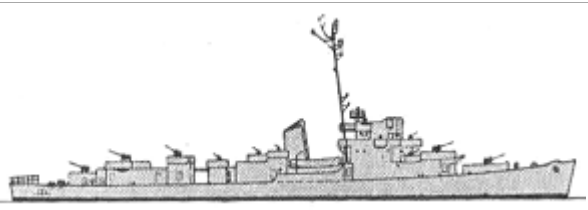
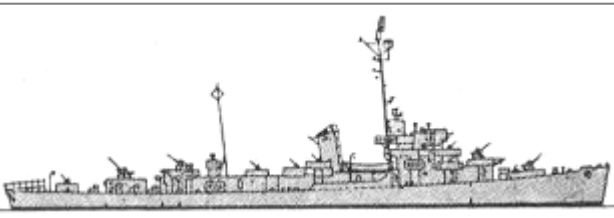
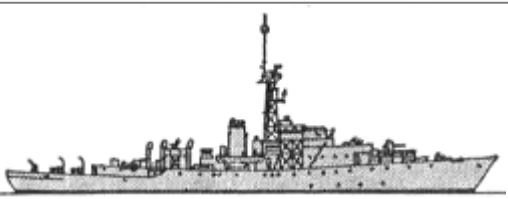
PRINCIPAL SURFACE COMBATANTS

DD	Kagero	1	DD12	Tanyang	1940		2600t, 118.5x10.8x3.8m, 3b,2gst, 52000hp, 35kts, 240p; 3x1-127/38, 2x1-76/50, 8x1-40/60, 4dct; SC-2 radar
	Benson	2	DD14	Loyang	1940		2591t, 106.2x11.0x4.0m, 4b,2gst, 50000hp, 35kts, 208p; 4x1-127/38, 2x2-40/60, 4x1-20/70, 1x5-533TT, 6dct, 2dcr; SC, Mk 4 radars, sonar
			DD15	Hanyang	1940		
	Gleaves	1	DD17	Nanyang	1940		2572t, 106.2x11.0x4.0m, 4b,2gst, 50000hp, 35kts, 208p; 4x1-127/38, (2x4+2x2)-40/60, 2x2-20/70, 6dct, 2dcr; SC, Mk4 radars, sonar
	Bristol	1	DD16	Hsienyang	1942		2600t, 106.2x11.0x4.9m, 4b,2gst, 50000hp, 35kts, 208p; 3x1-127/38, 2x2-40/60, 7x1-20/70, 2dct, 2dcr, mechanical minesweeping gear; SC, Mk4 radars, sonar
	Tachibana	1	DD15	Hsinyang	1945		1640t, 100.0x9.4x3.4m, 2b,2gst, 19000hp, 27.8kts, 211p; (1x2+1x1)-127/40, (4x3+17x1)-25/60, 1x4-610TT, 7dct, 2dcr; 13-go, 22-go radars
	Etorofu	1	PF77	Lingan	1943		1020t, 77.7x9.1x3.1m, 2d, 4200hp, 19.7kts, 147p; 3x1-120/45, 5x3-25/60, 1x1-81/12 ASWM, 6dct; 22-go radar

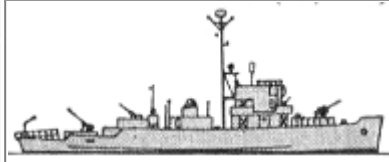
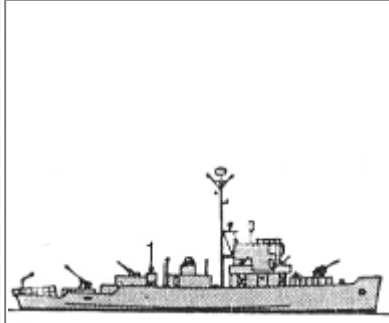
FF	Evarts	1	DE21	Taikang	1943		1416t, 88.7x10.7x3.1m, 4dg,2em, 6000hp, 19.5kts, 156p; 4x1-76/50, 1x2-40/60, 10x1-20/70, 8dct, 2dcr; SA, SF radars, sonar
	Cannon	4	DE23	Taiho	1943		1602t, 93.3x11.2x3.2m, 4dg,2em, 6000hp, 21kts, 186p; 4x1-76/50, 2x2-40/60, 11x1-20/70, 8dct, 2dcr; SA, SF radars, sonar
			DE24	Taihu	1943		
DE25			Taitsang	1943			
DE26			Taichao	1944			
Castle	2	PF80	Gaoan	1944		1630t, 76.8x11.2x4.2m, 2b,1vte, 2750hp, 16.5kts, 120p; 1x1-120/45, 1x1-76/40, 2x2-40/60; radar	
		PF81	Tean	1944			

PATROL AND COASTAL COMBATANTS

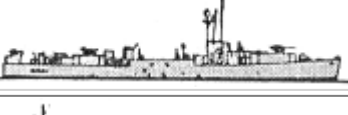
PCE	2	PCE62	Shanghai	1943		903t, 56.2x10.1x2.9m, 2d, 2000hp, 15.1kts, 96p; 2x1-76/50, 2x2-40/60, 2x1-20/70; SF radar	
		PCE68	Weiyuan	1943			
PS	Admirable	11	MSF43	Yongsheng	1943		945t, 56.2x10.1x3.0m, 2d, 2000hp, 15.1kts, 96p; 2x1-76/50, 2x2-40/60, 2x1-20/70; radar
			MSF44	Yongshun	1943		
			MSF45	Yongding	1943		
			MSF47	Yongjia	1944		
			MSF48	Yongxiu	1944		
			MSF49	Yongshou	1944		
			MSF50	Yongfeng	1944		
			MSF51	Yongchang	1945		
			MSF52	Yongchun	1945		
			MSF53	Yonghe	1944		
			MSF54	Yongkang	1945		
PT	PT1	2	PTC11		1957	No picture	40t, 21.6x6.1xm, 3pe, 40kts, 12p; 1x1-40/60, 1x2-20/70, 2-450TT
			PTC12		1957		
	Vosper 70ft	2	PTC32		1957		46t, 21.6x5.8x1.5m, 3pe, 42kts, 12p; 1x1-20/70, 2x2-12.7, 2-450TT
			PTC33		1957		
	ELCO 80ft	2	PTC34		1957		53t, 24.1x7.1x1.7m, 3pe, 39kts, 12p; 1x1-40/60, 2x1-12.7, 2-450TT
PTC35				1957			
Ch28	1	PC106	Qujiang	1944		442t, 51.0x6.7x2.6m, 2d, 1700hp, 16kts, 80p; 1x1-76/40, 1x3-25/60, 2x1-13.2, 2dcr	

PC	Ch4	1	1	Quojiang	1939		309t, 56.2x5.6x2.2m, 2d, 2600hp, 20kts, 59p; 1x2-40/62, 1x3-25/60, 2dct
				PC104	Tuojiang	1943	
	PC105	Peijiang	1942				
	PC108	Xianjiang	1943				
	PC109	Zijiang	1943				
	PC110	Yuanjiang	1943				
	PC111	Lijiang	1943				
	PC113	Gongjiang	1943				
	PC114	Bojiang	1943				
	PC115	Changjiang	1943				
	PC116	Qingjiang	1943				
	PC118	Zhangjiang	1943				
	PC119	Dongjiang	1944				
	PC120	Xijiang	1944				
	PC122	Beijiang	1944				
	PC123	Liujiang	1944				
	PC124	Ganjiang	1943				
PC125	Tuojiang	1943					
PGM 173ft	2	PC103	Qujiang	1945		463t, 52.9x7.1x3.3m, 2d, 2880hp, 19kts, 65p; 1x1-76/50, 1x2-40/60, 6x1-20/70, 1x2-60/12 mortar, 2x1-12.7; radar	
		PC117	Zhujiang	1945			
HDML	6	1, 2, 4-7	Fang 1,, 2, 4-7	1941-1944		54t, 22.0x4.8x1.4m, 2d, 300hp, 11.8kts, 10p; 2x1-20/70, 2dcr	
PB SC	8	SC102	Chuchien 102	1942		136t, 33.8x5.5x2.0m, 2d, 1000hp, 16kts, 27p; 1x1-40/60, 3x1-20/70, 2x4-178 Mousetrap ASWRL, 2dct, 2dcr; radar, QC sonar	
		SC103	Chuchien 103	1942			
		4		1942			
		5		1942			
		6		1943			
		7		1942			
		8		1942			
		9		1943			

AMPHIBIOUS

		LST201	Zhonghai	1944	
		LST203	Zhongding	1944	

LST	LST(2)	22	LST204	Zhongxing	1944		4080t, 1000x15.2x4.3m, 2d, 1800hp, 12.1kts, 125p; (2x2+6x1)-40/60, 12x1-20/70; 4 LCVP, 20tanks, 163troops; SO radar
			LST205	Zhongjian	1944		
			LST206	Zhongji	1944		
			LST208	Zhongxun	1944		
			LST209	Zhonglian	1945		
			LST210	Zhongrong	1944		
			LST216	Zhongguang	1943		
			LST217	Zhongzhao	1943		
			LST218	Zhongqi	1943		
			LST219	Zhongxi	1944		
			LST221	Zhongquan	1944		
			LST222	Zhongsheng	1944		
			LST223	Zhongfu	1944		
			LST224	Zhongcheng	1945		
			LST225	Zhongqiang	1945		
			LST226	Zhongzhi	1945		
			LST227	Zhongming	1945		
			LST228	Zhongsu	1944		
			LST229	Zhongwang	1944		
			LST230	Zhongbang	1944		
LSM	LSM1	14	LSM341	Meizhen	1944		1095t, 62.0x10.5x2.1m, 2d, 2800hp, 13kts, 60p; 1x2-40/60, 4x1-20/70; 5tanks, 54troops; SO radar
			LSM343	Meiyi	1944		
			LSM344	Meipeng	1945		
			LSM345	Meiheng	1945		
			LSM346	Meihong	1945		
			LSM347	Meisong	1945		
			LSM348	Meihe	1944		
			LSM349	Meijian	1944		
			LSM350	Meihua	1944		
			LSM351	Meicheng	1944		
			LSM352	Meigong	1945		
			LSM353	Meiping	1945		
			LSM354	Meiwei	1945		
			LSM355	Meihan	1945		
LCI(L)		6	LCI261	Lianzhu	1943		385t, 48.9x7.2x1.6m, 8d(2), 2320hp, 15.5kts, 29p; 5x1-20/70; 209troops; SO radar
			LCI262	Lianli	1944		
			LCI263	Lianshen	1944		
			LCI264	Lianhua	1944		
			LCI265	Lianzhen	1944		
			LCI266	Lianqiang	1944		

LSS	LCT(6)	17	LCU481	Hequn	1944		320t, 36.3x10.0x1.2m, 3d, 675hp, 8kts, 13p; 2x1-20/70; 4tanks
			LCU482	Hezhong	1944		
			LCU483	Hecheng	1944		
			LCU484	Hezhong	1944		
			LCU485	Hezhang	1943		
			LCU486	Hezhen	1944		
			LCU487	Hezhi	1944		
			LCU494	Hechun	1944		
			LCU495	Heyong	1944		
			LCU496	Hejian	1944		
			LCU401	Heqi	1944		
			LCU402	Hehui	1944		
			LCU403	Heyao	1944		
			LCU404	Hedeng	1944		
			LCU405	Hefeng	1944		
			LCU406	Hechao	1944		
			LCU407	Heteng	1944		
Heshan	6	LCU488	Heshan	1955		360t, 36.3x10.4x1.8m, 3d, 675hp, 10kts, 15p; 3x1-20/70; 3tanks; radar	
		LCU489	Hechuan	1955			
		LCU490	Hesheng	1955			
		LCU491	Heheng	1955			
		LCU492	Hemao	1955			
		LCU493	Heshou	1955			
LC	LCVP	70	1-70	1943-1945		13t, 11.2x3.2x0.9m, 2d, 220hp, 8kts, 3p; 2x1-12.7; 36troops	
LCF	LCS(L)	3	LCI271	Lianzhi	1944		387t, 48.2x7.2x1.7m, 8d(2), 2320hp, 15.5kts, 71p; (2x2+1x1)-40/60(271,272), 3x2-40/60(273), 4x1-20/70, 10x1-127 RL; radar
			LCI272	Lianren	1944		
			LCI273	Lianyong	1945		

MINE WARFARE





ML	Sokuten	1	29	Jieh 29	1915		435t, 45.7x7.6x2.3m, 1b,1vte, 600hp, 12.8kts, 40p; 2x1-76/40, 2x1-13.2, 4dct, 120mines, mechanical minesweeping gear
	Hirashima	1	PF75	Yongjing	1942		750t, 75.5x7.9x2.6m, 2d, 3500hp, 20kts, 100p; 1x1-76/40, 2x3-25/60, 4dct, 120mines
MSC	Bluebird	4	MSC155	Yungping	1954		400(155,156)-390(157,158)t, 44.3x8.1x2.1m, 2d, 1200(155,156)-880(157,158)hp, 13kts, 39p; 1x2-20/70, mechanical, acoustic, magnetic minesweeping gear; SPS-53 radar, UQS-1 sonar
MSC156	Yungan		1954				
MSC157	Yungnien		1959				
MSC158	Yungchou		1959				

© Ivan Gogin, 2016



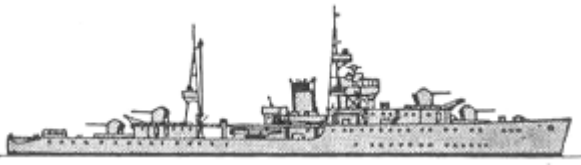
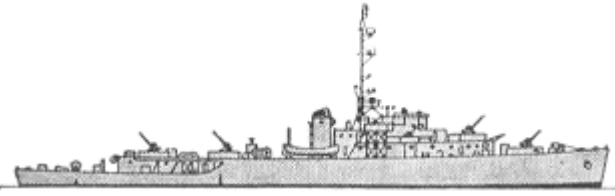
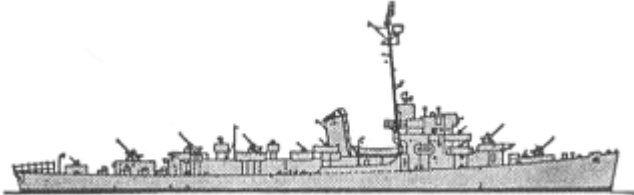

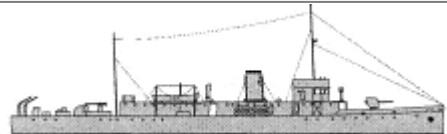
[home](#)[World navies yesterday](#)[1960](#)

Thailand 01 January 1960

PRINCIPAL SURFACE COMBATANTS

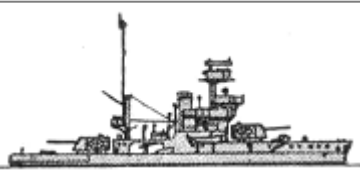
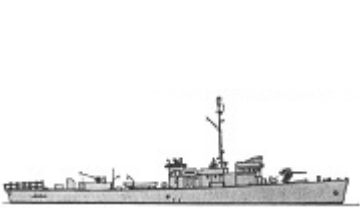
FF	Tachin	1	1	Meklong	1937		2000t, 82.0x10.4x3.1m, 2b,2vte, 2500hp, 17kts, 155p; 4x1-120/45, 2x1-40/60, 2x1-20/65, 2x2-450TT, mines, sweeps
	Tacoma	2	1	Tachin	1943		2238t, 92.6x11.4x3.9m, 3b,2vte, 5500hp, 20kts, 190p; 3x1-76/50, 1x2-40/60, 9x1-20/70, 1x24-178 Hedgehog ASWRL, 8dct, 2dcr; SPS-5(1), SPS-6, SPS-10(2), Mk51 radars, sonar
			2	Prasae	1944		
Cannon	1	3	Pin Clao	1944		1602t, 93.3x11.2x3.2m, 4dg,2em, 6000hp, 21kts, 186p; 3x1-76/50, 3x2-40/60, 6x1-20/70, 1x24-178 Hedgehog ASWRL, 8dct, 2dcr; SC, SPS-5, Mk52, 2x Mk63 radars, SQS-11 sonar	
FS	Trad	7	11	Trad	1936		470t, 68.0x6.4x2.1m, 2b,2gst, 9000hp, 31kts, 70p; 3x1-76/40, 2x1-20/65, (2x2+2x1)-450TT
			12	Puket	1936		
			13	Patani	1938		
			21	Surasdra	1938		
			22	Chandraburi	1938		
			23	Rayong	1938		
			31	Chunphorn	1938		
Hunt	1	1	Chao Phraya	1919		840t, 70.4x8.7x2.2m, 2b,2vte, 2200hp, 16kts, 65p; 2x1-76/40, 1x1-40/39	
Flower mod.	1	4	Bangpakong	1943		1370t, 62.5x10.1x4.4m, 2b,1vte, 2750hp, 16.5kts, 109p; 1x1-102/45, (1x2+2x1)-20/70, 1x24-178 Hedgehog ASWRL, 4dct, 2dcr; type 276, 291 radars, sonar	

PATROL AND COASTAL COMBATANTS

PS	Ratanakosindra	1	Ratanakosindra	1925		1000t, 53.0x11.3x3.3m, 2b,2vte, 850hp, 12kts, 102p; 2x1-152/50, 4x1-76/40, 4x1-40/39	
		2	Sukhotai	1930			
PC	PC 173'	1	Sarasin	1942		463t, 52.9x7.1x3.3m, 2d, 2880hp, 19kts, 65p; 1x1-76/50, 1x1-40/60, 5x1-20/70, 2x4-178 Mousetrap ASWRL, 2dct, 2dcr; SO radar, QCU-2 sonar	
		2	Thayanchon	1942			
		4	Phali	1944			
		5	Sukrip	1944			
		6	Tongpliu	1942			
		7	Liulom	1943			
		8	Longlom	1942			
		PT	Klongyai	5			Klongyai
6	Takbai			1937			
7	Kantang			1937			
8	Sattahip			1958			
PB	Sarasindhu	2	Thiew Uthock	1936		50t, 21.9x3.9x1.0m, 2d, 150hp, 9kts; 1x1-20/70	
		3	Travane Vari	1936			
	No1	4	2, 4-6		1945-1948	No picture	16t, 12.5kts; 1x1-20/70
	CG 83'	2	11, 12		1953		63t, 25.3x4.3x1.6m, 2d, 1100hp, 18kts; 1x1-20/70, 2x4-178 Mousetrap ASWRL; radar, sonar
	CG 95'	4	13		1954		105t, 29.0x5.8x1.6m, 4d(2), 2200hp, 18kts, 15p; 1x1-20/70, 2x4-178 Mousetrap ASWRL, 2dcr; SPN-21 radar, QCU sonar
			14		1954		
			15		1954		
			16		1954		
SC 110'	3	31		1955		125t, 33.9x5.2x1.8m, 2d, 18kts; 1x1-40/60, 3x1-20/70, 2x4-178 Mousetrap ASWRL, 2dct, 2dcr	
		32		1955			
		33		1955			

AMPHIBIOUS

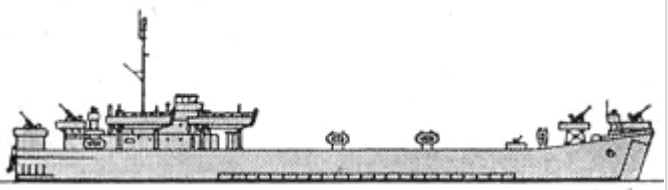
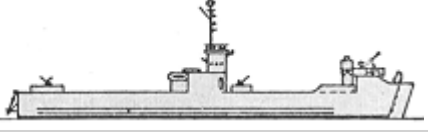
LST	LST1	1	1	Angthong	1944		4080t, 100.0x15.2x4.3m, 2d, 1800hp, 12.1kts, 125p; (1x2+5x1)-40/60, 12x1-20/70; 20tanks, 163troops; SO-8 radar
LSM	LSM1	2	1	Kut	1944		1095t, 62.0x10.5x2.1m, 2d, 2800hp, 13kts, 60p; 1x2-40/60, 4x1-20/70; 5tanks, 54troops; SO-8 radar
			2	Phai	1945		
			8	Mataphon	1944		

LCU	LCT(6)	6	9	Rawi	1944		320t, 36.3x10.0x1.2m, 3d, 675hp, 8kts, 13p; 2x1-20/70; 4tanks
			10	Adang	1944		
			11	Phetra	1944		
			12	Khorum	1944		
			13	Talibong	1944		
LCI(L)	2	1	Prab	1944		385t, 48.9x7.2x1.6m, 8d(2), 2320hp, 15.5kts, 29p; 2x1-20/70; 209troops; SO radar	
		2	Sattakut	1944			
LC	LCVP	6	51-56	1943-1945		13t, 11.2x3.2x0.9m, 2d, 300hp, 8kts, 3p; 2x1-12.7; 36troops	

MINE WARFARE

ML	Bangrachan	2	1	Bangrachan	1936		408t, 50.0ppx7.7x2.2m, 2d, 540hp, 13kts, 55p; 2x1-76/40, 2x1-20/70, 142mines
			2	Nangsarai	1937		
MSO	Algerine VTE	1	1	Phosamton	1945		1335t, 68.6x10.8x3.3m, 2b,2vte, 2400hp, 16kts, 138p; 1x1-102/45, 3x1-20/70, 2dct, 2dcr, sweeps; radar, sonar
MSC	YMS	3	2	Ladya	1943		320t, 41.5x7.5x2.4m, 2d, 800hp, 14kts, 60p; 1x1-76/50, 2x1-20/70, 2dct, 2dcr, sweeps; SO radar
			3	Bangkeo	1943		
			4	Ta Din Daeng	1943		
MSB	M1	5	1-5	M1-5	1945	No picture	30t, 17.0x5.3x1.4m, 2d, 10kts, 7p; 1x1-12.7, sweeps

© Ivan Gogin, 2016

[home](#)[World navies yesterday](#)[1960](#)

Tunisia 01 January 1960

PRINCIPAL SURFACE COMBATANTS

FS	Chamois	1	E71	Destour	1939		900t, 78.3x8.7x3.3m, 2d, 4000hp, 20kts, 106p; 1x2-90/50, 1x1-40/60, 6x1-20/70, 4dct, 2dcr; radar
----	---------	---	-----	---------	------	--	--

PATROL AND COASTAL COMBATANTS



PB	VC1	1	P201	Istiklal	1957		82t, 31.8x4.7x1.7m, 2d, 2700hp, 28kts, 17p; 2x1-20/70; Decca 1226 radar
----	-----	---	------	----------	------	--	---

© Ivan Gogin, 2016



[home](#)[World navies yesterday](#)[1960](#)

Turkey 01 January 1960

SUBMARINES



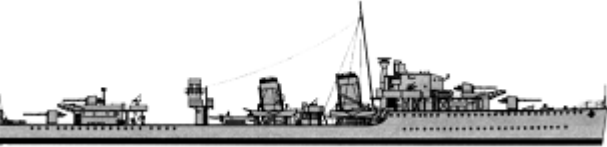
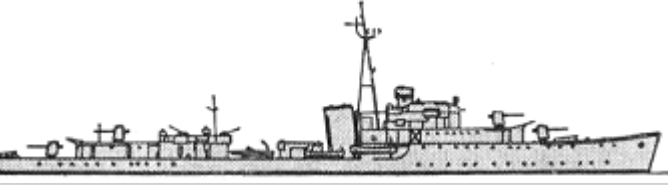

SS	Balao	5	S330	Birinci İnönü	1944		1845/2415t, 95.0x8.3x4.7m, 4dg,4em(2), 5400/2740hp, 20.2/8.7kts, 60p, 120m; 2x1-127/25, 2x1-40/60, 10-533TT; SS, ST, SV radars, sonars
			S331	İkinci İnönü	1944		
			S332	Sakarya	1944		
			S333	Çanakkale	1944		
			S334	Gür	1944		
Gato	2	S340	Preveze	1944		1810/2410t, 95.0x8.3x4.7m, 4dg,4em(2), 5400/2740hp, 20.2/8.7kts, 60p, 90m; 2x1-127/25, 2x1-40/60, 10-533TT; SS, ST, SV radars, sonars	
		S341	Cerbe	1944			
Balao Fleet Snorkel	1	S342	Turgut Reis	1944		1830/2440t, 95.0x8.3x5.2m, 4dg,4em(2), 4610/2700hp, 20/10kts, 82p, 120m; 1x1-127/25, 10-533TT; SS, ST, SV radars, BQR-2, BQS-2, SQR-3 sonars	

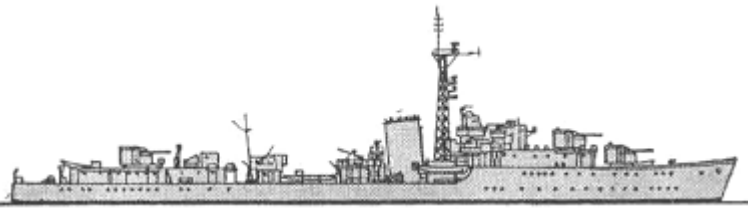
PRINCIPAL SURFACE COMBATANTS

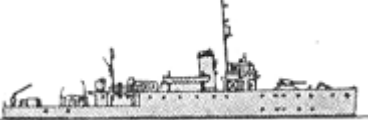

DD	Demirhisar	3	D340	Muavenet	1942		2080t, 98.5x10.2x4.0m, 3b,2gst, 34000hp, 35.5kts, 145p; 4x1-120/45, 6x1-40/60, 2x1-20/70, 2x4-533TT(1,2), 1x4-533TT(3), 2dct, 1dcr, type 271, 291 radars, sonar
			D342	Demirhisar	1942		
			D343	Sultanhisar	1942		
O	1	D341	Gayret	1941		2430t, 105.2x10.7x4.3m, 2b,2gst, 40000hp, 37kts, 212p; 4x1-120/45, 2x2-40/60, 1x4-533TT, 4dct, 2dcr; type 272, 282, 285, 291 radars, type 123A, 127 sonars	
DD	Bristol	4	D344	Gaziantep	1942		2600t, 106.2x11.0x4.9m, 4b,2gst, 50000hp, 35kts, 208p; 4x1-127/38(1,4), 3x1-127/38(2,3), 2x2-76/50(2,3), 2x2-40/60(1,4), 1x5-533TT, 1x24-178 Hedgehog ASWRL, 6dct, 2dcr; SPS-6, SPS-10, SPG-53 radars, sonar
			D345	Giresun	1942		
			D346	Gelibolu	1942		
			D347	Gemlik	1942		
			D348	Alp Arslan	1942		



M	4	D349	Mareşal Fevzi Çakmak	1941		2840t, 110.5x11.2x4.5m, 2b,2gst, 48000hp, 36kts, 226p; 3x2-120/50, (1x2+4x1)-40/60, 1x4-533TT, 1x3-305 Squid ASWRL; type 271, 282, 285, 290 radars, sonar
		D350	Kılıç Ali Paşa	1942		
		D351	Piyale Paşa	1942		

PATROL AND COASTAL COMBATANTS

PS	RCN Bangor	10	P121	Bafra	1941		875t, 54.9x8.7x3.1m, 2b,2vte, 2400hp, 16.5kts, 87p; 1x1-40/60, 2x1-20/70, 1x24-178 Hedgehog ASWRL, 4dct, 2dcr, sweeps; radar, sonar
			P122	Beykoz	1942		
			P123	Beylerbeyi	1941		
			P124	Biga	1941		
			P125	Bodrum	1942		
			P126	Bornova	1942		
			P127	Bozcaada	1941		
			P128	Büyükdere	1942		
			P129	Bandırma	1942		
			P130	Bartın	1942		
YP	MTB1	10	P311-320	MTB1-10	1942	No picture	70t, 21.8x4.2x2.6m, 2d, 2000hp, 20kts, 8p; 1x1-20/70
	HDML	8	1-8	LSB1-8	1942-1943		54t, 22.0x4.8x1.4m, 2d, 260-320hp, 11-11.8kts, 10p; 1x1-47/40, 1x1-20/70, 2dcr, sonar
	Fairmile B	8	1-8	AB1-8	1943-1944		86t, 34.8x5.6x1.5m, 2pe, 1200hp, 18kts, 16p; 1x1-47/40, (1x2+1x1)-20/70, 2dct, 2dcr; type 286 radar, sonar
	USCG 83ft	4	P339, 308-310	LS9-12	1953		63t, 25.3x4.3x1.6m, 2d, 1100hp, 18kts; 1x1-20/70, 2x4-178 Mousetrap ASWRL; radar, sonar

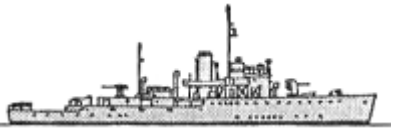
MINE WARFARE

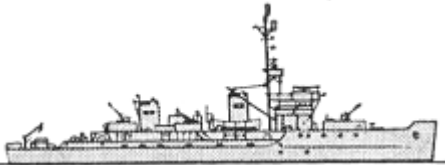
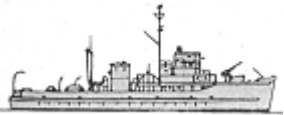

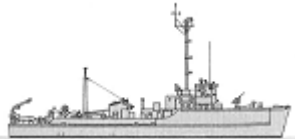
ML	Atak	1	1	Atak	1938	No picture	500t, 44.0x8.0x3.6m, 1d, 1025hp, 13kts; 40mines
	Sivrihisar	2	1	Sivrihisar	1940		375t, 52.5x7.9x1.8m, 2d, 1200hp, 15kts, 60p; 1x1-75/55, 1x1-40/39, 40mines, 2dcr
			2	Torgud Reis	1940		
	LSM1	3	N101	Mordoğan	1945		1100t, 61.9x10.5x2.6m, 2d, 2880hp, 12kts, 89p; 3x2-40/60, 5x1-20/70, 400mnes; 2x nav. radars
			N102	Meriç	1945		
N103			Marmaris	1945			
YMP	1	N115	Mehmedçik	1958	No picture	540t, 39.6x10.7x3.1m, 2d, 600hp, 10kts, 22p; 1x1-40/60, mines; Decca 12 radar	
Bathurst	5	M500	Antalya	1942		790t, 56.7x9.5x3.0m, 2b,2vte, 1550-2000hp, 15-16kts, 80-90p; 1x1-102/45, 1x1-40/60, 2x1-20/70, 4dct, 2dcr, sweeps; radar, sonar	
		M501	Alanya	1942			
		M502	Amasra	1942			
		M503	Hamit Nacı	1942			
		M504	Ayvalık	1942			



MSO	Auk	8	M505	Çeşme	1943		1250t, 67.4x9.8x3.3m, 2dg,2em, 2880hp, 18kts, 105p; 1x1-76/50, 6x1-20/70, 4dct, 2dcr, 80mines, sweeps; radar, sonar
			M506	Çarşamba	1943		
			M507	Çardak	1943		
			M508	Çandarlı	1944		
			M509	Edincik	1943		
			M510	Erdemli	1943		
			M511	Ereğli	1943		
			M512	Erdemit	1943		
MSC	YMS	8	M513	Kozlu	1943		320t, 41.5x7.5x2.4m, 2d, 800hp, 14kts, 60p; 1x1-76/50, 2x1-20/70, 2dct, 2dcr, sweeps; radar
			M514	Kuşadası	1944		
			M515	Karamürsel	1943		
			M517	Kas	1942		
			M518	Kilimli	1943		
			M519	Kerempe	1943		
			M520	Kemer	1943		
			M521	Kirte	1944		
MSC	Canadian Cape	4	M522	Trabzon	1953		412t, 46.3x8.5x2.6m, 2d, 2400hp, 15kts, 40p; 1x1-40/60, sweeps; Decca TM1226 radar
			M523	Terme	1954		
			M524	Tirebolu	1954		
			M525	Tekirdağ	1954		
MSC	Adjutant	4	M510	Samsun	1958		392t, 44.3x8.0x2.6m, 4d(2), 880hp, 13kts, 38p; 1x2-20/70, sweeps; Decca 1226 radar, UQS-1D sonar
			M511	Sinop	1959		
			M512	Sürmene	1959		
			M513	Seddülbahir	1959		

[home](#)[World navies yesterday](#)[1960](#)

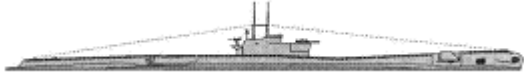
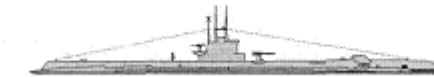
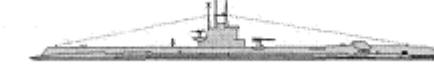
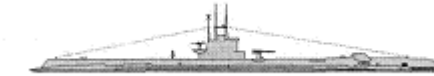
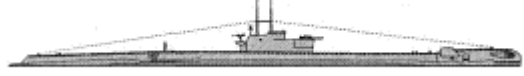
United Kingdom 01 January 1960

SUBMARINES

SS	T 1940	4	S14	Tactician	1942		1327/1575t, 83.8x8.1x4.5m, 2d/em, 2500/1450hp, 15.2/9kts, 61p, 95m; 1x1-102/40, 11-533TT; type 291W radar, sonar
			S87	Tally-Ho	1943		
			S39	Taurus	1942		
			S12	Trespasser	1942		
	S 1940	3	S89	Seraph	1942		842/990t, 66.1x7.2x4.5m, 2d/em, 1900/1300hp, 14.7/9kts, 48p, 95m; 1x1-20/70, 7-533TT; type 267QW radar, sonar
			S76	Sirdar	1943		
			S227	Spiteful	1943		
	S 1941 riveted	2	S137	Scythian	1944		842/990t, 66.1x7.2x4.5m, 2d/em, 1900/1300hp, 14.7/9kts, 48p, 95m; 1x1-20/70, 6-533TT; type 267QW radar, sonar
			S46	Statesman	1943		
	S 1941 welded	2	S143	Scotsman	1944		814/990t, 66.1x7.2x4.5m, 2d/em, 1900/1300hp, 14.7/9kts, 48p, 95m; 1x1-20/70, 6-533TT; type 267QW radar, sonar
			S44	Sea Devil	1945		
	T 1941/42 riveted	5	S21	Telemachus	1943		1327/1571t, 83.4x8.1x4.5m, 2d/em, 2500/1450hp, 15.2/9kts, 61p, 95m; 1x1-102/40, 11-533TT; type 267W radar, sonar
			S24	Thorough	1944		
			S25	Thule	1944		
			S31	Trenchant	1944		
			S126	Tudor	1944		
	T Conversion	8	S34	Taciturn	1944		1588/1734t, 88.8-89.5x8.1x4.9m, 4d/em(2), 2800/6000hp, 14/15.4kts, 68p, 110m; 6-533TT; type 267W, type 186, 187, 197 sonars
S55			Thermopylae	1945			
S54			Turpin	1944			
S52			Totem	1945			
S53			Truncheon	1952			
S32			Tiptoe	1944			
S33			Trump	1944			
S42			Tabard	1946			
T Streamlined	5	S77	Tireless	1945		1424/1571t, 83.4x8.1x4.8m, 2d/em, 2500/1450hp, 15.2/9.5kts, 50p, 95m; 6-533TT; type 267W radar, type 186, 187, 197 sonars	
		S35	Tapir	1944			
		S38	Teredo	1946			
		S37	Talent	1945			
		S28	Token	1945			

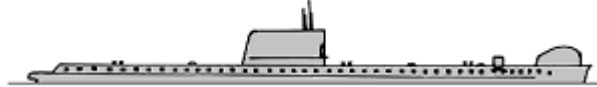
S 1942/43	6	S153	Sea Scout	1944		814/990t, 66.1x7.2x4.3m, 2d/em, 1900/1300hp, 14.7/9kts, 48p, 110m; 1x1-20/70, 6-533TT; type 291W radar, sonar
		S154	Selene	1944		
		S75	Seneschal	1945		
		S56	Sentinel	1945		
		S62	Solent	1944		
		S58	Scorcher	1945		
A	15	S61	Acheron	1948		1443/1620t, 85.9x6.8x5.5m, 2d/em, 4300/4300hp, 19/15kts, 63p, 105m; 6-533TT; type 267W radar, type 186, 187, 197 sonars
		S72	Aeneas	1946		
		S41	Alaric	1946		
		S65	Alcide	1946		
		S66	Alderney	1946		
		S67	Alliance	1945		
		S68	Ambush	1947		
		S43	Amphion	1945		
		S64	Anchorite	1947		
		S63	Andrew	1948		
		S49	Artemis	1947		
		S96	Artful	1948		
		S47	Astute	1945		
		S69	Auriga	1946		
		S26	Aurochs	1947		
Porpoise	5	S01	Porpoise	1958		1975/2303t, 88.5x8.1x5.6m, 2d/em, 3680/6000hp, 12/17kts, 71p, 200m; 8-533TT; type 1002 radar, type 187, 2007, 2019 sonars
		S02	Rorqual	1958		
		S03	Narwhal	1959		
		S04	Grampus	1958		
		S06	Cachalot	1959		
SSX Stickleback	4	X51	Stickleback	1955	No picture	35/39t, 16.4x1.8x2.3m, 1d/em, 50/44hp, 6.5/6kts, 5p, 90m; 2x 2t charges
		X52	Shrimp	1955		
		X53	Sprat	1955		
		X54	Minnow	1955		

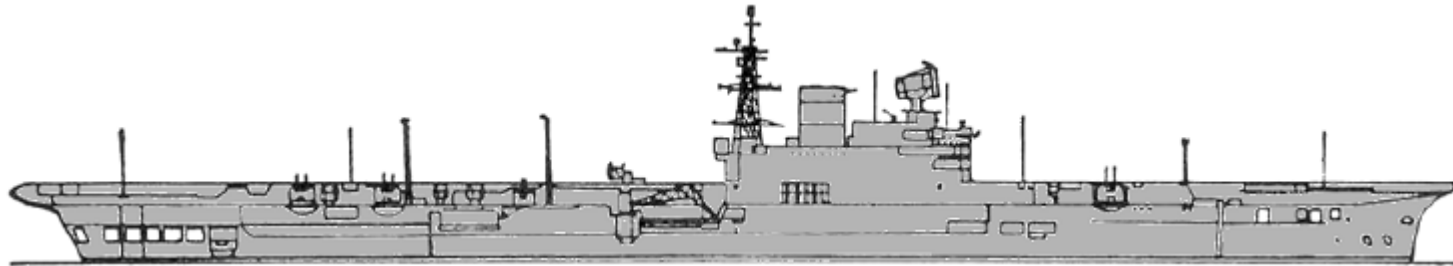

AIRCRAFT CARRIERS

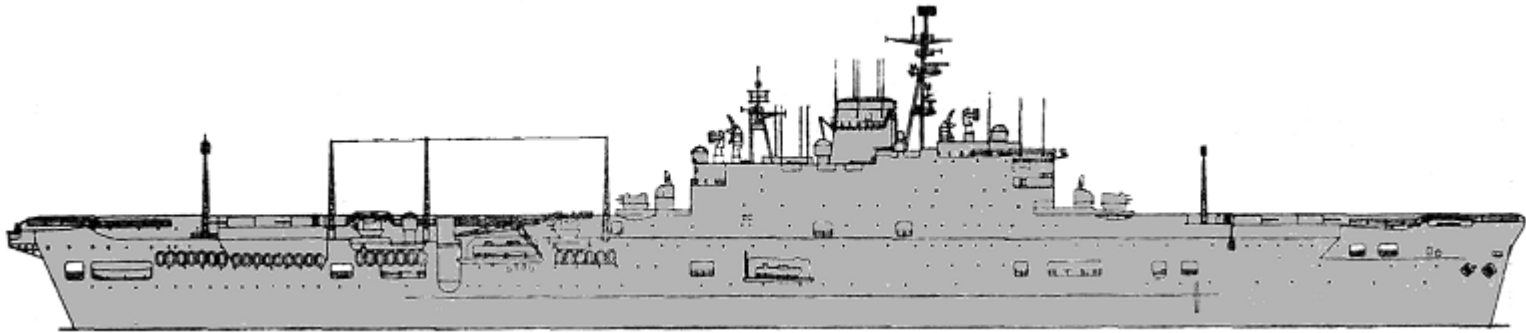
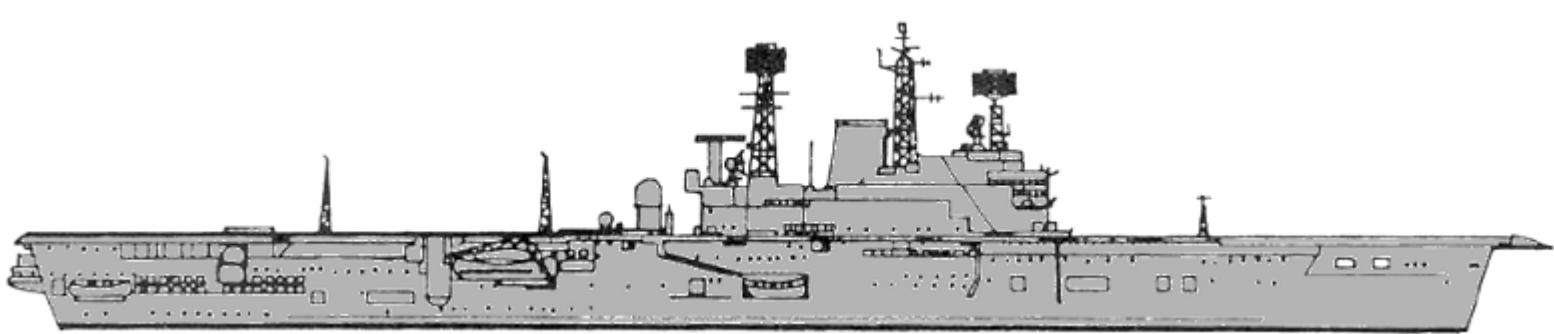
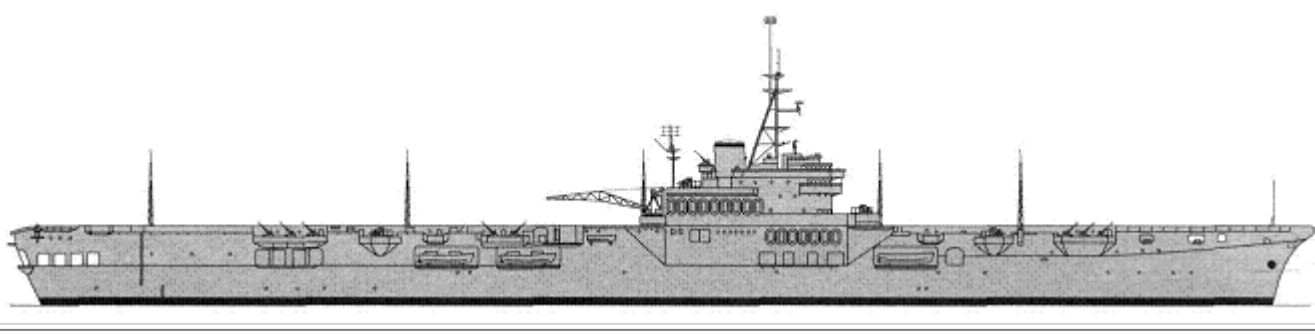
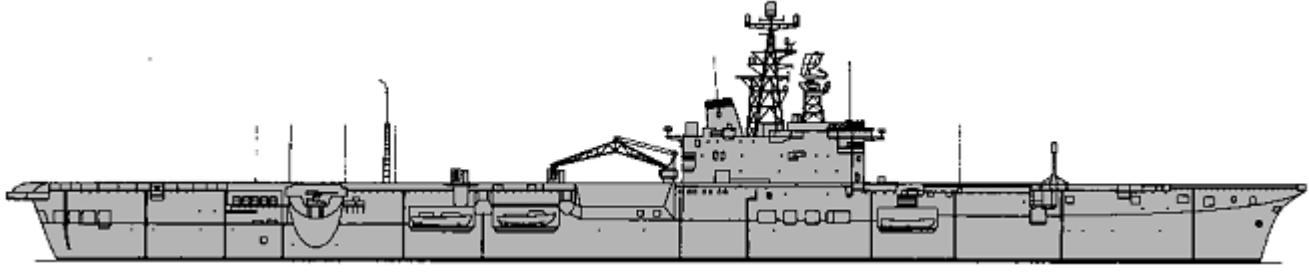
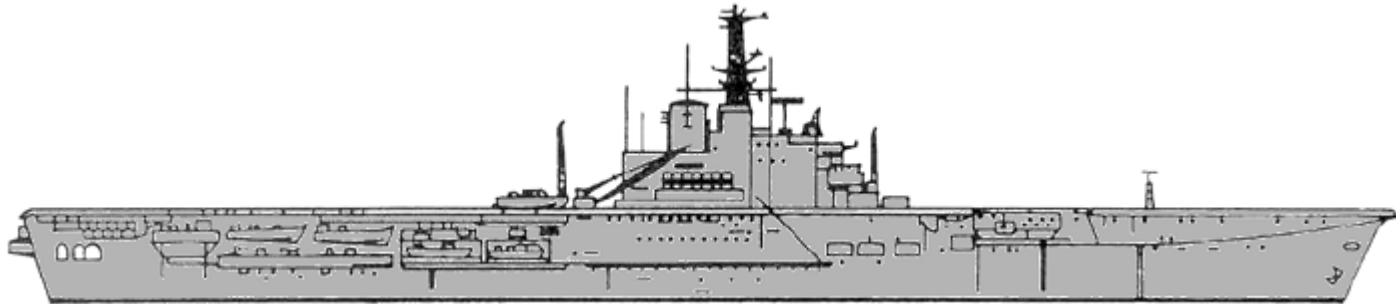
Illustrious	1	R38	Victorious	1941		35500t, 238.0x47.8x9.5m, 6b,3gst, 111000hp, 31kts, 2400p; 102belt, 76deck; 6x2-76/50, 1x6-40/60, 36aircraft (Sea Hawk, Sea Venom, Scimitar, Sea Vixen fighters, Skyraider EW planes, Gannet ASW planes, Sea Devon cargo planes, Dragonfly, Sycamore, Whirlwind helicopters); type 272, 277, 279, 281B, 6x 282,
-------------	---	-----	------------	------	--	--

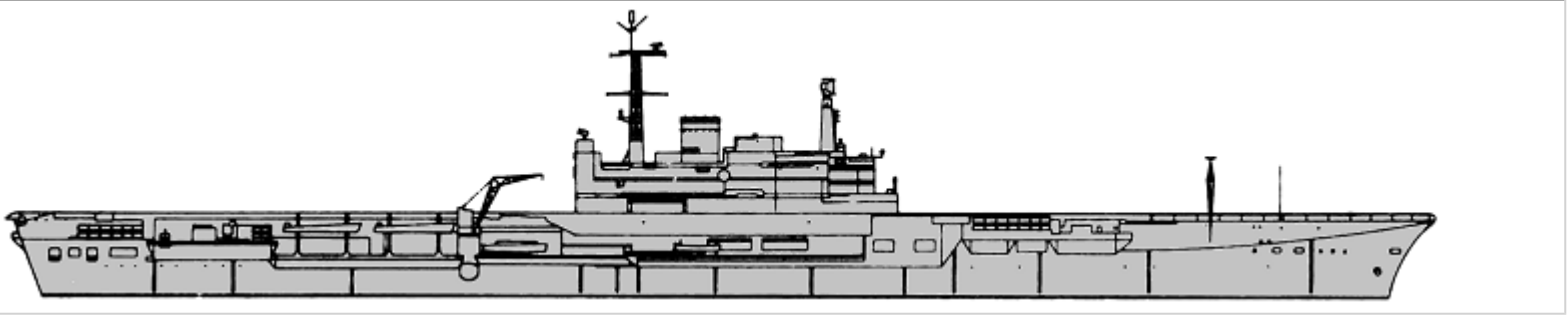
CV	Eagle	1	R05	Eagle	1951		293, SG(R38) radars 53390t, 245.0x52.1x11.0m, 8b,4gst, 152000hp, 31kts, 2750p; 102belt, 152deck; 8x2-120/45, (8x6+2x2+9x1)-40/60, 60aircraft(Sea Hawk, Sea Venom, Scimitar, Sea Vixen fighters, Skyraider EW planes, Gannet ASW planes, Sea Devon cargo planes, Dragonfly, Sycamore, Whirlwind helicopters); type 960, 940, 982, 983, 242Q, 293Q, 4x 275, 8x 262 974 radars
	Ark Royal	1	R09	Ark Royal	1955		53060t, 245.0x50.1x11.0m, 8b,4gst, 152000hp, 31kts, 2637p; 102belt, 152decks; 4x2-120/45, (4x6+2x2)-40/60, 50aircraft(Sea Hawk, Sea Venom, Scimitar, Sea Vixen fighters, Skyraider EW planes, Gannet ASW planes, Sea Devon cargo planes, Dragonfly, Sycamore, Whirlwind helicopters); type 960, 2x 982, 2x 983, 2x 275, 4x 262, 974, 965M radars
CVL	Colossus	1	R16	Triumph	1946		18300t, 211.8x24.4x7.1m, 4b,2gst, 40000hp, 25kts, 1300p; 12x1-40/60, 6x4-40/39, 37aircraft (Sea Hawk, Sea Venom, Scimitar, Sea Vixen fighters, Skyraider EW planes, Gannet ASW planes, Sea Devon cargo planes, Dragonfly, Sycamore, Whirlwind helicopters); type 277, 293 radars, type 144 sonar
	Majestic	1	R36	Magnificent	1948		17780t, 211.8x24.4x7.0m, 4b,2gst, 40000hp, 25kts, 1300p; 19x1-40/60, 6x4-40/39, 37aircraft (Sea Hawk, Sea Venom, Scimitar, Sea Vixen fighters, Skyraider EW planes, Gannet ASW planes, Sea Devon cargo planes, Dragonfly, Sycamore, Whirlwind helicopters); type 277, 293 radars, type 144 sonar
	Centaur	3	R06 R07 R08	Centaur Albion Bulwark	1953 1954 1954		27000t, 224.8x37.5x8.2m, 4b,2gst, 78000hp, 28kts, 1400p; 25belt, 19deck; (1x6+8x2+4x1)-40/60, 26aircraft (Sea Hawk, Sea Venom, Scimitar, Sea Vixen fighters, Skyraider EW planes, Gannet ASW planes, Sea Devon cargo planes, Dragonfly, Sycamore, Whirlwind helicopters); type 982, 983, 275, 974 radars

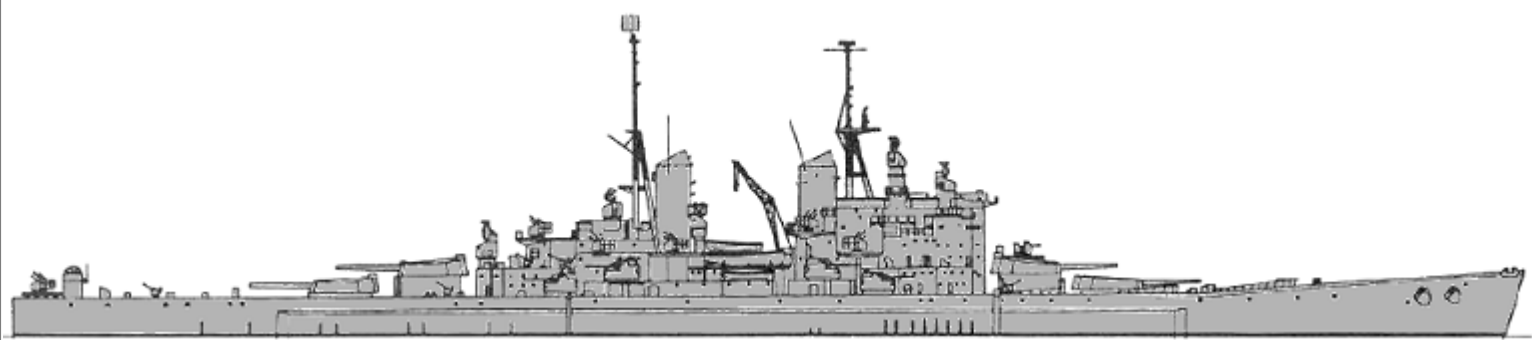
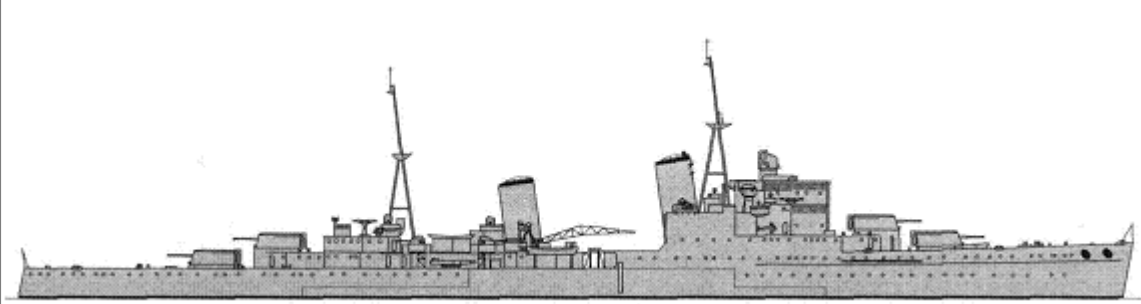
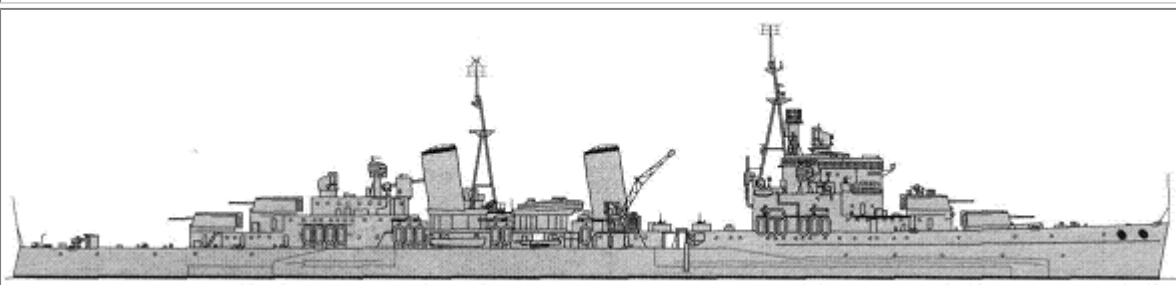

	Hermes	1	R12	Hermes	1959		28700t, 226.9x44.1x8.8m, 4b,2gst, 76000hp, 28kts, 2100p; 25belt, 19deck; 5x2-40/60, 28aircraft (Sea Hawk, Sea Venom, Scimitar, Sea Vixen fighters, Skyraider EW planes, Gannet ASW planes, Sea Devon cargo planes, Dragonfly, Sycamore, Whirlwind helicopters); type 984, 982, 262, 974 radars
AV	Ripon	1	A116	Skua	1945	No picture	990t, 64.0x10.7x4.2m, 2d, 960hp, 10.5kts; 1x1-76/40, 2x1-20/70

PRINCIPAL SURFACE COMBATANTS

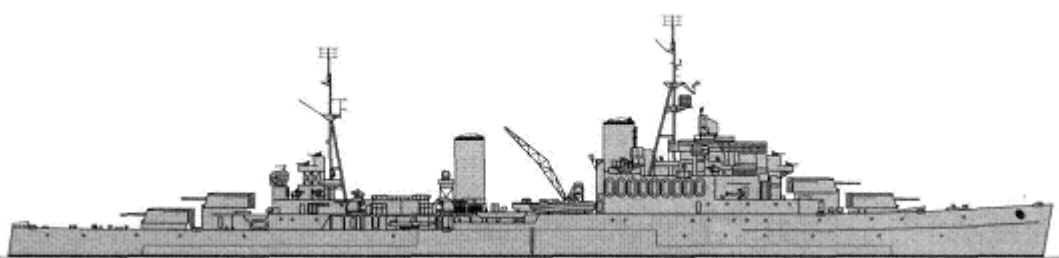
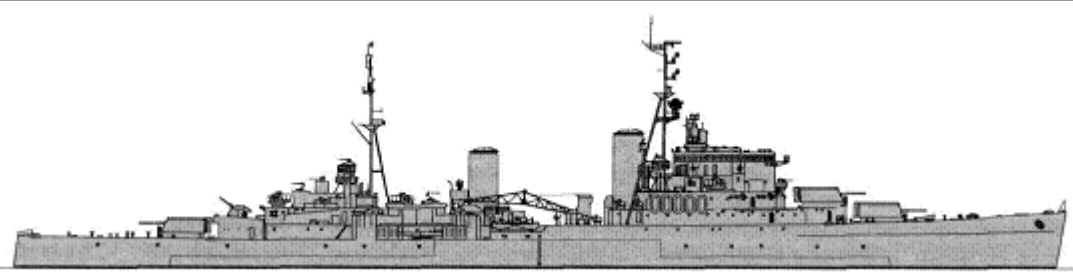
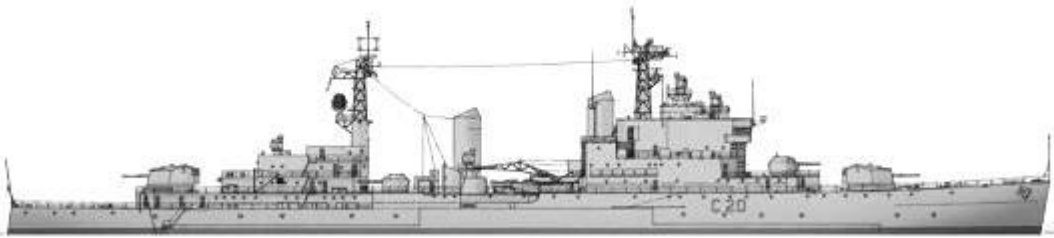
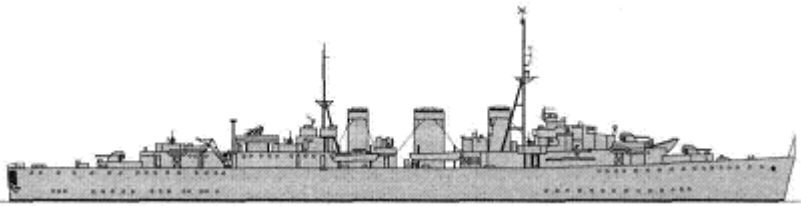
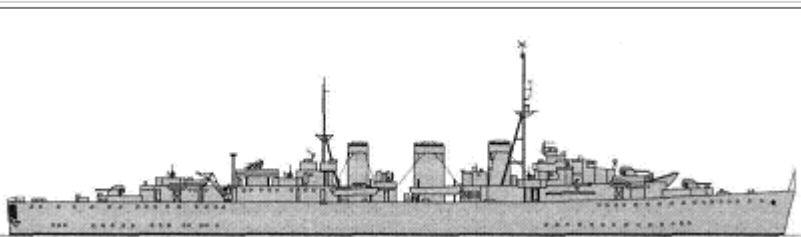
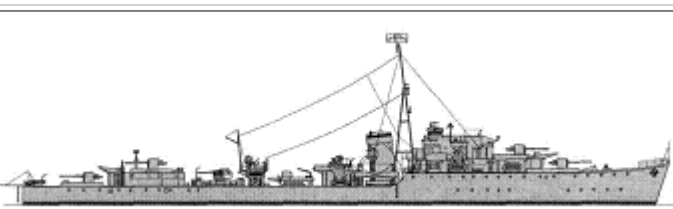
BB	Vanguard	1	B23	Vanguard	1946		51420t, 248.2x32.9x9.4m, 8b,4gst, 130000hp, 30kts, 1975p; 356belt, 152deck, 330turrets, 76CT; 4x2-381/42, 8x2-133/50, (9x6+1x2)-40/60; type 960, 277, 293, 268, 930, 2x 274, 4x 275, 11x 262 radars
	Southampton	2	C19	Birmingham	1937		12190t, 180.3x18.8x6.2m, 4b,4gst, 75000hp, 32kts, 748p; 114belt, 38deck, 25turrets; 3x3-152/50, 4x2-102/45, 4x4-40/60(C19), (4x4+10x1)-40/60(C24), 2x4-40/39, (10x2+9x1)-20/70(C19), (10x2+7x1)-20/70(C24), 2x3-533TT; type 273(C19), 277(C24), 281(C24), 281B(C19), 282(C24), 283(C24), 284, 285(C24), 2x 275 radars
			C24	Sheffield	1937		
	Edinburgh	1	C35	Belfast	1939		14900t, 187.0x20.2x7.1m, 4b,4gst, 80000hp, 30.5kts, 850p; 114belt, 76deck, 102turrets; 4x3-152/50, 4x2-102/45, 6x2-40/60, 2x3-533TT; type 268, 274, 277, 281B, 282, 285, 293, 4x 903 radars
			C52	Bermuda	1942		11090t, 169.3x18.9x6.3m, 4b,4gst, 72500hp, 31.5kts, 730p; 89belt, 51deck, 51turrets; 3x3-152/50(C52,44,80), 4x3-152/50(C48), 4x2-102/45, 4x1-
			C48	Gambia	1942		
			C44	Jamaica	1942		



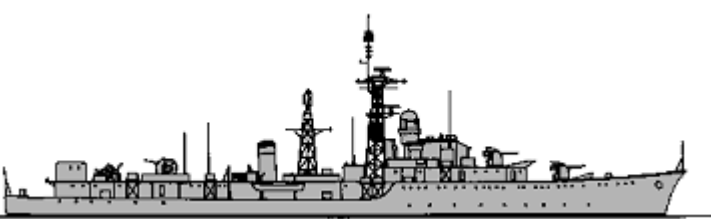
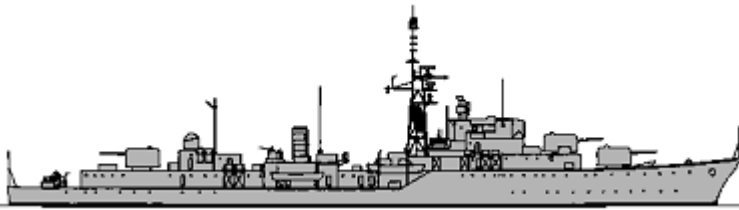
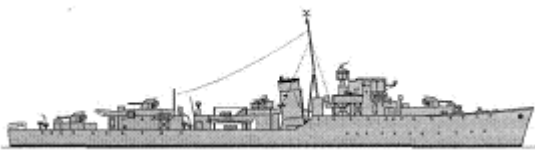
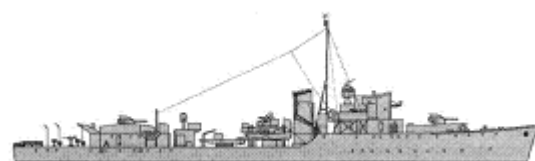

CL	Fiji	4	C80	Mauritius	1941		40/60(C52), 2x1-40/60(C44), (5x4+4x1)-40/39(C52), 2x4-40/39(C48), 5x4-40/39(C44,80), (2x2+2x1)-20/70(C52), 10x2-20/70(C48), (2x2+10x1)-20/70(C44), 24x1-20/70(C80), 2x3-533TT, type 272(C48,44), 273(C52,44,80), 277(C52), 279(C14,80), 281(C48,44,80), 281B(C52), 283(C48), 284, 285, 293(C52) radars
	Swiftsure	1	C08	Swiftsure	1944		11240t, 169.3x19.2x6.5m, 4b,4gst, 72500hp, 31.5kts, 855p; 89belt, 51deck, 51turrets; 3x3-152/50, 5x2-102/45, 13x1-40/60, 4x4-40/39, 2x3-533TT; type 277, 281B, 282, 283, 284, 285, 293 radars
	Tiger	1	C20	Tiger	1959		11700t, 169.3x19.5x7.0m, 4b,4gst, 80000hp, 31.5kts, 880p; 89belt, 51deck, 51turrets; 2x2-152/50, 3x2-76/70; type 277Q, 5x 903, 960, 992Q radars
CM	Abdiel	1	N70	Manxman	1941		3415t, 127.4x12.2x4.6m, 4b,2gst, 72000hp, 39.7kts, 246p; 2x2-102/45, 1x4-40/39, (4x2+4x1)-20/70, 156mines; type 276, 282, 285, 286, 291 radars
	Apollo	2	N01	Apollo	1944		4100t, 127.4x12.2x4.9m, 4b,2gst, 72000hp, 39.7kts, 257p; 2x2-102/45, (2x2+6x1)-40/60(N01), (3x2+5x1)-40/60(N65), 156mines; type 272(N01), 276(N65), 282, 285, 291 radars
			N65	Ariadne	1943		
O	2	D139	Obdurate	1942		2430t, 105.2x10.7x4.3m, 2b,2gst, 40000hp, 37kts, 212p; 4x1-102/45, 1x4-40/39, (2x2+2x1)-20/70, 2x4-533TT, 4dct, 2dcr, 60mines; type 272, 282, 285, 291 radars, type 123A, 127 sonars	
		D248	Obedient	1942			
							2545t, 110.6x10.9x4.4m,

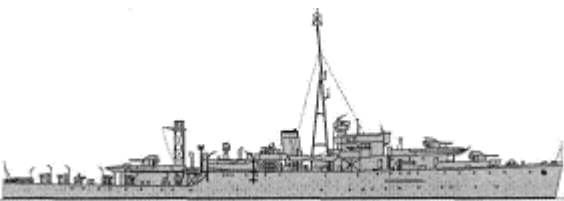
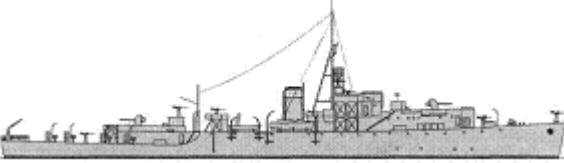
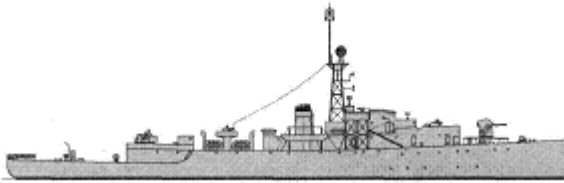
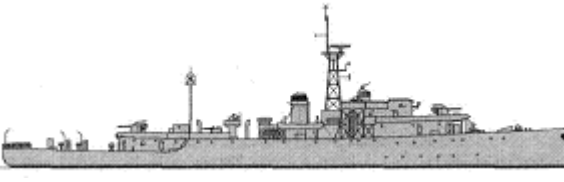
DD	S	1	D27	Savage	1943		2b,2gst, 40000hp, 36.7kts, 225p; (1x2+2x1)-114/45, 6x2-20/70, 2x4-533TT, 4dct, 2dcr; type 275, 277, 282, 291 radars, type 123A, 127 sonars
	Ca	8	D15	Cavendish	1945		2675t, 110.6x10.9x4.4m, 2b,2gst, 40000hp, 36.7kts, 192p; 3x1-114/45(all-D30), 2x1-114/45(D30), (1x2+2x1)-40/60, 1x4-533TT, 2x3-305 Squid ASWRL; type 275, 293P/Q, 978/974, 944 radars, type 170, 174P sonars
			D07	Caesar	1944		
			D85	Cambrian	1944		
			D01	Caprice	1944		
			D30	Carron	1944		
			D25	Carysfort	1945		
			D10	Cassandra	1944		
			D73	Cavalier	1944		
	Battle batch 1	14	D14	Armada	1945		3300t, 115.5x12.3x4.6m, 2b,2gst, 50000hp, 35.7kts, 222p; 2x2-114/45, (4x2+4x1)-40/60, 2x4-533TT, 1x3-305 Squid ASWRL, 4dct, 2dcr; type 262, 275, 277, 283, 291, 293 radars, type 123A, 127 sonars
			D80	Barfleur	1944		
			D32	Camperdown	1945		
			D55	Finisterre	1945		
D24			Gravelines	1946			
D74			Hogue	1945			
D44			Lagos	1945			
D65			St. James	1946			
D18			St. Kitts	1946			
D84			Saintes	1946			
D60			Sluys	1946			
D70			Solebay	1945			
D77			Trafalgar	1945			
D231			Vigo	1946			
Ch	6	D52	Chaplet	1945		2535t, 110.6x10.9x4.4m, 2b,2gst, 40000hp, 36.7kts, 222p; 3x1-114/45, (1x2+4x1)-40/60, 2x1-20/70, 1x4-533TT, 2x3-305 Squid ASWRL, 2dct, 2dcr; type 275, 277, 282, 291 radars, type 123A, 127 sonars	
		D61	Chequers	1945			
		D90	Cheviot	1945			
		D51	Chevron	1945			
		D36	Chieftain	1946			
		D91	Childers	1945			
Co	6	D34	Cockade	1945		2535t, 110.6x10.9x4.4m, 2b,2gst, 40000hp, 36.7kts, 222p; 3x1-114/45, (1x2+4x1)-40/60, 2x1-20/70, 1x4-533TT, 2x3-305 Squid ASWRL, 2dct, 2dcr; type 275, 277, 282, 291 radars, type 123A, 127 sonars	
		D26	Comet	1945			
		D03	Concord	1946			
		D76	Consort	1946			
		D48	Contest	1945			
		D57	Cossack	1945			
		D86	Agincourt	1947			

Battle batch 2	8	D22	Aisne	1947		3420t, 115.5x12.3x4.7m, 2b,2gst, 50000hp, 35.7kts, 306p; (2x2+1x1)-114/45, (3x2+2x1)-40/60, 2x5-533TT, 1x3-305 Squid ASWRL; type 262, 275, 277, 283, 291, 293 radars, type 170, 174/177 sonars
		D17	Alamein	1948		
		D68	Barrosa	1947		
		D97	Corunna	1947		
		D09	Dunkirk	1946		
		D62	Jutland	1947		
		D43	Matapan	1947		
		D118	Battleaxe	1947		
D31	Broadsword	1948				
Weapon	4	D96	Crossbow	1948		2935t, 111.3x11.6x4.5m, 2b,2gst, 40000hp, 34kts, 234p; 2x2-102/45, (2x2+2x1)-40/60, 2x3-305 Squid ASWRL(all-D64), 1x3-305 Squid ASWRL(D64); type 965 AKE-1, 293, 262, 903 radars, type 170, 174/177 sonars
		D64	Scorpion	1947		
		D108	Dainty	1953		
Daring	8	D05	Daring	1952		3580t, 118.9x13.1x4.1m, 2b,2gst, 54000hp, 34.7kts, 330p; 3x2-120/45, 3x2-40/60, 1x5-533TT; type 262, 275, 277, 291, 293 radars, type 170, 174/177 sonars
		D106	Decoy	1953		
		D114	Defender	1952		
		D119	Delight	1953		
		D35	Diamond	1952		
		D126	Diana	1954		
		D154	Duchess	1952		
		Hunt batch 1	1	F142		
Hunt batch 2	1	F70	Farndale	1941		1625t, 85.3x9.6x3.8m, 2b,2gst, 19000hp, 27kts, 168p; 3x2-102/45, 1x4-40/39, 4x1-20/70, 2dct, 3dcr; type 271, 285, 291 radars, type 123A, 127 sonars
Hunt batch 3	1	F118	Talybont	1943		1590t, 85.3x9.6x3.7m, 2b,2gst, 19000hp, 27kts, 168p; 2x2-102/45, 2x1-40/60, 1x4-40/39, 1x2-533TT, 4dct, 2dcr; type 272, 285, 291 radars, type 123A, 127 sonars
Hunt batch 4	2	F176	Brecon	1942		1700(F176)-1750(F79)t, 90.2x10.2x3.6m, 2b,2gst, 19000hp, 26kts, 170p; 3x2-102/45, 2x1-40/60(F176), 1x4-40/39(F176), (1x4+1x1)-40/39(F79), 2x1-20/70(F176), 4x2-20/70(F79), 1x3-533TT, 4dct, 2dcr; type 272, 285, 291 radars, type
		F79	Brissenden	1943		

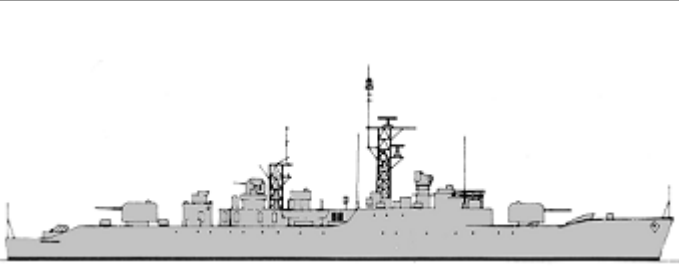

						123A, 127 sonars
Black Swan modified batch 2	5	F123	Crane	1944		1950t, 91.3x11.7x3.5m, 2b,2gst, 4300hp, 19.7kts, 192p; 3x2-102/45, (2x2+2x1)-40/60(F42,33), (4x2+2x1)-20/70(F123,49), (2x2+2x1)-20/70(F42), 2x1- 20/70(F33), 8dct, 2dcr; type 275, 277, 282, 291 radars, type 123A, 177 sonars
		F42	Modeste	1945		
		F33	Opossum	1945		
		F49	Pheasant	1943		
		F20	Snipe	1946		
River	3	F155	Ballinderry	1943		2180t, 91.8x11.2x3.9m, 2b,2vte, 5500hp, 20kts, 140p; 2x1-102/40(F155,257), 6x1- 40/60(F155,257), 3x1- 40/60(F369), 4x1-20/70(F369), 1x24-178 Hedgehog ASWRL(F155,257), 8dct, 2dcr; type 277, 291 radars, sonars
		F257	Wessex	1943		
		F369	Meon	1944		
Loch	14	F603	Loch Arkaig	1945		2260t, 93.6x11.8x3.8m, 2b,2vte(all- F603,655)-2b,2gst(F603,655), 5500(all- F603,655)-6000(F603,655)hp, 19.5(all- F603,655)-20(F603,655)kts, 177p; 1x1- 102/45(F603,609,425, 620, 391,639), 1x2- 102/45(F390,429,433, 628,437,645, 655,658), 2x1- 40/60(F609), 4x1- 40/60(F390,429,433, 628,437,645, 655,658), 1x4- 40/39, (4x2+2x1)-20/70(F603,425,620, 391,639), 2x1-20/70(F609, 603,609,425, 619,620, 391,639), 2x3-305 Squid ASWRL, 2dct, 1dcr; type 277(F603,609,425, 620, 391,639), 277Q(F390,429,433, 628,437,645, 655,658), 291 radars, sonars
		F609	Loch Craggie	1944		
		F425	Loch Dunvegan	1944		
		F390	Loch Fada	1944		
		F429	Loch Fyne	1944		
		F620	Loch Gorm	1944		
		F433	Loch Insh	1944		
		F391	Loch Killin	1944		
		F628	Loch Killisport	1945		
		F437	Loch Lomond	1944		
		F639	Loch More	1945		
		F645	Loch Ruthven	1944		
		F655	Loch Tralaig	1945		
		F658	Loch Veyatie	1946		
Bay	5	F630	Cardigan Bay	1945		2420t, 93.7x11.8x3.9m, 2b,2vte, 5500hp, 19.5kts, 177p; 2x2-102/45, (2x2+2x1)-40/60, (2x2+2x1)-20/70, 1x24-178 Hedgehog ASWRL, 4dct, 2dcr; type 276, 285, 291 radars, sonars
		F624	Morecambe Bay	1949		
		F627	Mounts Bay	1946		
		F650	Porlock Bay	1946		
		F600	St. Brides Bay	1945		
		F647	Alert	1946		2420t, 93.7x11.8x3.9m,

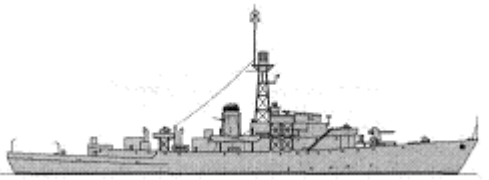
FF	Surprise	2	F436	Surprise	1945	A black and white line drawing of the HMS Surprise (F436), a Type 276 frigate, shown from a starboard profile view. It features a complex superstructure with multiple masts and radar equipment.	2b,2vte, 5500hp, 19.5kts, 177p; 1x2-102/45, 2x1-40/60; type 276, 285, 291 radars, sonars
	type 15	21	F138	Rapid	1943	A black and white line drawing of a Type 15 frigate, shown from a starboard profile view. It has a similar design to the Surprise but with a slightly different superstructure.	2850t, 109.2x10.9x4.3m, 2b,2gst, 40000hp, 36.7kts, 195p; 1x2-102/45, (1x2+3x1)-40/60, 2x3-305 Squid ASWRL, helodeck(F197,53); type 278, 262, 293 radars, type 170, 174 sonars
			F185	Relentless	1942		
			F191	Rocket	1943		
F195			Roebuck	1943			
F09			Troubridge	1943			
F197			Grenville	1943			
F83			Ulster	1943			
F17			Ulysses	1943			
F53			Undaunted	1944			
F141			Undine	1943			
F08			Urania	1944			
F196			Urchin	1943			
F200			Ursa	1944			
F50			Venus	1943			
F29			Verulam	1943			
F93			Vigilant	1943			
F76			Virago	1943			
F41			Volage	1944			
F159			Wakeful	1944			
F187	Whirlwind	1944					
F42	Wizard	1944					
F102	Zest	1944					
type 16	10	F98	Orwell	1942	A black and white line drawing of a Type 16 frigate, shown from a starboard profile view. It has a more compact superstructure than the Type 15.	2593t, 109.2x10.9x4.9m, 2b,2gst, 40000hp, 180; 1x2-102/45, (1x2+3x1)-40/60, 1x4-533TT, 2x3-305 Squid ASWRL, 60mines(all-F26); type 293, 974 radars, type 170, 174P sonars	
		F169	Paladin	1941			
		F26	Petard	1942			
		F23	Teazer	1943			
		F44	Tenacious	1943			
		F189	Termagant	1943			
		F19	Terpsichore	1944			
		F121	Tumult	1943			
		F156	Tuscan	1943			
F67	Tyrian	1943					
		F78	Blackwood	1957			
		F80	Duncan	1958			
		F48	Dundas	1956			
		F84	Exmouth	1957			

Blackwood	12	F51	Grafton	1957		1535t, 94.5x10.7x4.7m, 2b,1gst, 15000hp, 27kts, 140p; 3x1-40/60, 2x3-305 Limbo ASWRL; type 974, 291 radars, type 174, 170, 162 sonars
		F54	Hardy	1955		
		F85	Keppel	1956		
		F88	Malcolm	1957		
		F91	Murray	1956		
		F94	Palliser	1957		
		F62	Pellew	1956		
		F97	Russell	1957		
Whitby	6	F77	Blackpool	1958		2560t, 112.7x12.5x3.9m, 2b,2gst, 30000hp, 29kts, 231p; 1x2-120/45, 1x2-40/60, (2x2+8)-533TT(F36,43,63,65), 2x3-305 Limbo ASWRL; type 275, 262, 293, 277, 974/978 radars, type 162, 170, 174/177 sonars
		F73	Eastbourne	1958		
		F63	Scarborough	1957		
		F65	Tenby	1957		
		F43	Torquay	1956		
		F36	Whitby	1956		
Leoprad	4	F14	Leopard	1958		2520t, 103.6x12.2x3.6m, 8d(2), 14400hp, 25kts, 205p; 2x2-120/45, 1x2-40/60(F14,27,34), 1x1-40/60(F37), 1x3-305 Squid ASWRL; type 275, 262(F14,27,34), 903(F37), 960, 974, 992Q(F14,27,34), 965 AKE-1(F37), 978, 993 radars, type 170, 174, 162 sonars
		F27	Lynx	1957		
		F34	Puma	1957		
		F37	Jaguar	1959		
Salisbury	3	F32	Salisbury	1957		2350t, 103.6x12.2x3.6m, 8d(2), 14400hp, 25kts, 205p; 1x2-120/45, 1x2-40/60, 1x3-305 Squid ASWRL; type 275, 262, 277, 960, 982, 293, 974, 978, 993 radars, type 170, 174, 162 sonars
		F59	Chichester	1958		
		F61	Llandaff	1958		
FFL Castle	7	F286	Amberley Castle	1944		1630t, 76.8x11.2x4.2m, 2b,1vte, 16.5kts, 120p; 1x1-102/40, (2x2+4x1)-20/70, 1x3-305 Squid ASWRL, 2dct, 1dcr; type 276, 291 radars, sonars
		F388	Dumbarton Castle	1944		
		F413	Farnham Castle	1945		
		F691	Lancaster Castle	1944		
		F693	Morpeth Castle	1944		
		F692	Oxford Castle	1944		
		F372	Rushen Castle	1944		

PATROL AND COASTAL COMBATANTS

MTB601	5	MTB610		1942		118t, 35.1x6.5x1.5m, 4pe, 4800hp, 29kts, 30p; 2x1-57/43(MTB), 1x1-40/60(MASB), 1x2-20/70, 2x2-12.7/62, 2-533TT(MTB610,624), 4-450TT(MTB761), 2x12-178 Split Hedgehog ASWRL(MASB), 2dc(MTB), 4dc(MASB); type 286U radar
		MTB624		1942		
		MASB3002		1944		
		MTB761		1944		
		MASB3053		1945		
Gay	12	P1041	Gay Archer	1952		65t, 22.9x6.1x1.2m, 3pe, 4500hp, 40kts, 13p; 1x1-114/19 or 2-533TT, 1x1-40/60; radar
		P1042	Gay Bombardier	1952		
		P1043	Gay Bowman	1952		
		P1044	Gay Bruiser	1953		
		P1045	Gay Carabineer	1953		
		P1046	Gay Cavalier	1953		
		P1047	Gay Centurion	1952		
		P1048	Gay Charger	1953		
		P1049	Gay Charioteer	1953		
		P1050	Gay Dragoon	1953		
		P1051	Gay Fencer	1953		
		P1052	Gay Forester	1954		
Bold	1	P5720	Bold Pathfinder	1953		150t, 37.4x7.8x2.1m, 2gt+2d(4), 14000hp, 30kts, 18p; 2x1-114/19 or 4-533TT, 1x1-40/60; radar
Dark	18	P1101	Dark Adventurer	1954		64t, 21.8x5.9x1.8m, 2d, 5000hp, 40kts, 15p; 1x1-114/19 or 4-533TT or 6mines, 1x1-40/60; radar
		P1102	Dark Aggressor	1955		
		P1103	Dark Antagonist	1955		
		P1104	Dark Biter	1955		
		P1105	Dark Avenger	1955		
		P1107	Dark Rover	1954		
		P1108	Dark Buccaneer	1954		
		P1109	Dark Clipper	1955		
		P1110	Dark Highwayman	1955		
		P1111	Dark Killer	1956		
		P1112	Dark Hussar	1957		

			P1113	Dark Fighter	1955		
			P1114	Dark Gladiator	1957		
			P1115	Dark Hero	1957		
			P1116	Dark Hunter	1954		
			P1118	Dark Intruder	1955		
			P1119	Dark Invader	1955		
			P1120	Dark Scout	1958		
PS	Ford	15	P3101	Shalford	1952		160t, 35.7x6.1x1.5m, 3d, 1200hp, 18kts, 19p; 1x1-40/60, 1x3-305 Squid ASWRL(P3101), 2dct(all-P3101), 2dcr(all-P3101); type 978 radar, type 144 sonar
			P3102	Aberford	1952		
			P3103	Axford	1954		
			P3106	Bryansford	1954		
			P3107	Camberford	1953		
			P3109	Greatford	1953		
			P3111	Gifford	1954		
			P3114	Mayford	1954		
			P3115	Hinksford	1955		
			P3116	Ickford	1954		
			P3119	Dubford	1953		
			P3121	Kingsford	1955		
			P3122	Marlingford	1954		
			P3123	Tilford	1956		
P3124	Montford	1957					
YP	Fairmile B	12	SDML2155, 2250, 2342, 2489, 2491, 2561, 2571, 2583, 2585, 2592, 2840 RML716		1940 - 1945		86t, 34.8x5.6x1.5m, 2pe, 1200hp, 18kts, 16p; 1x1-47/40, (1x2+1x1)-20/70, 2dct, 2dcr; type 291 radar, sonar
	HDML	11	SDB1323, 3516 SML352, 1197-1204		1940 - 1945		54t, 22.0x4.8x1.4m, 2d, 260-480hp, 11-12.5kts, 10p; 2x1-20/70, 2dcr; type 291 radar

COMMAND

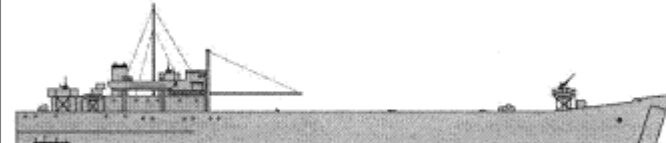
LSTQ	LST(3)	1	L105	Ben Lomond	1945		4980t, 105.9x16.8x3.8m, 2b,2vte, 5500hp, 13.5kts, 111p; 2x2-40/60, (2x2+2x1)-20/70; 5 LCA, 170troops; radar
------	--------	---	------	------------	------	--	---



AMPHIBIOUS

			L101	Anzio	1945		
			L108	Dieppe	1945		
			L111	Lofoten	1945		

LST	LST(3)	15	L132	Chaser	1945		4980t, 105.9x16.8x3.8m, 2b,2vte, 5500hp, 13.5kts, 111p; 2x2-40/60, (2x2+2x1)-20/70; 5 LCA, 1 LCT(6), 20 tanks, 14 trucks, 170troops; radar
			L115	Puncher	1945		
			L112	Messina	1945		
			L114	Narvik	1946		
			L117	Ravager	1945		
			L123	Slinger	1945		
			L119	Reggio	1945		
			L121	Salerno	1945		
			L128	Striker	1945		
			L129	Sulva	1945		
			L130	Tracker	1945		
			L120	Zeebrugge	1945		
LCU	LCT(4)	3	L1274		1944		640t, 57.1x11.8x1.4m, 2d, 920hp, 10kts, 12p; 2x1-20/70; 9 tanks
			L1283		1945		
			L1312		1944		
	LCT(8)	12	L4001	Redoubt	1945		810t, 68.6x11.6x1.5m, 2d, 1760hp, 11.9kts, 13p; 3x1-20/70; 8 tanks, 42 troops; radar
			L4025		1945		
			L4038	Citadel	1945		
			L4039	Parapet	1945		
			L4040	Bastion	1945		
			L4043	Counterguard	1945		
			L4044	Portcullis	1945		
			L4049		1945		
			L4050		1945		
			L4064	Sallyport	1946		
			L4098		1946		
			L4099	Buttress	1946		
LC	LCA	286			1940-1944		12t, 12.6x3.1x0.7m, 2pe, 130hp, 8kts, 4p; 2x1-51/11mortars; 40 troops
	LCP(L)	10			1941-1943		8t, 11.3x3.4x1.1m, 1pe, 150-225hp, 10-12kts, 3p; 25 troops or 1 vehicle
	LCM(7)	51			1943-1944		63t, 18.4x4.9x1.1m, 2d, 290hp, 11kts, 6p; 1x2-12.7/62; 1 tank or 100 troops

MINE WARFARE AND MINE COUNTERMEASURES

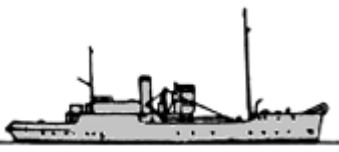
	Plover	1		Plover	1937		1020t, 59.5x11.4x3.1m, 2b,2vte, 1400hp, 14.7kts, 69p; 1x1-20/70, 100mines; radar
	Linnet	1		Linnet	1938		498t, 49.9x8.3x2.4m, 1b,1vte, 400hp, 10.5kts, 24p; 1x1-20/70, 12mines; radar

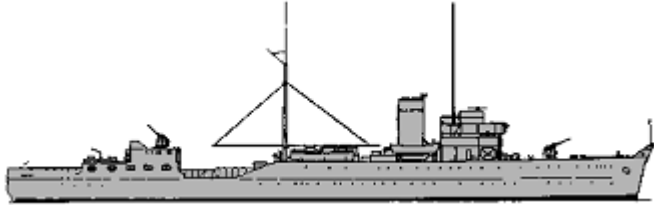
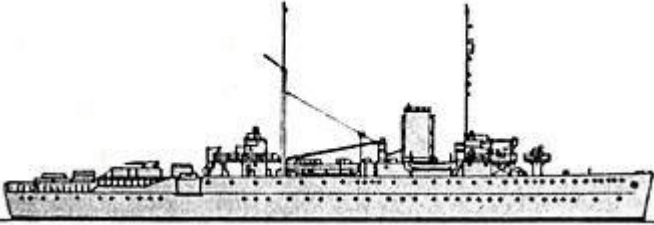
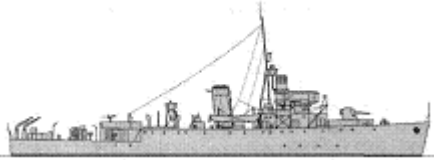
ML							
	M1	8	Miner I	1939		346t, 33.6x8.1x2.4m, 2d, 360hp, 10kts, 32p; 1x1-20/70, 10mines; type 286 radar	
			Gossamer	1940			
			Miner III	1940			
			Miner IV	1940			
			Miner V	1941			
			Miner VI	1942			
			Steady	1944			
Miner VIII			1943				
NL	Guardian	1	Guardian	1933		3665t, 103.0x16.2x4.2m, 2b,2gst, 6500hp, 18kts, 181p; 1x2-102/45, (4x2+6x1)-20/70, nets; radar	
	Protector	1	Protector	1936		3610t, 103.0x16.2x4.2m, 2b,2gst, 9000hp, 20kts, 190p; 1x2-102/45, (2x2+3x1)-20/70, nets; radar	
MSO	Algerine turbine	14	M106	Acute	1942		1265t, 68.6x10.8x3.2m, 2b,2gst, 2000hp, 16.5kts, 138p; 1x1-102/45, 4x1-40/60(M390), 4x2-20/70(all-M390), 4dct, 2dcr, sweeps; radar, sonar
			M01	Albacore	1942		
			M387	Chamaeleon	1944		
			M88	Cheerful	1944		
			M214	Circe	1942		
			M216	Espiegle	1942		
			M390	Jewel	1944		
			M227	Mutine	1943		
			M221	Onyx	1943		
			M294	Pincher	1943		
			M295	Plucky	1943		
			M298	Recruit	1944		
			M299	Rifleman	1944		
			M225	Rinaldo	1943		
	M11	Bramble	1945				
	M29	Cockatrice	1943				
	M307	Hound	1942				
	M276	Lennox	1944				

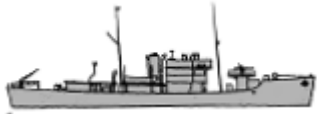
Algerine VTE	11	M442	Niger	1945		1325t, 68.6x10.8x3.3m, 2b,2vte, 2400hp, 16.5kts, 138p; 1x1-102/45, 4x1-40/60(M385,386), 4x2-20/70(all-M385,386), 4dct, 2dcr, sweeps; radar, sonar
		M383	Tanganyika	1944		
		M304	Waterwitch	1943		
		M385	Wave	1944		
		M386	Welcome	1945		
		M376	Golden Fleece	1944		
		M456	Nerissa	1945		
Isles	9	M202	Fetlar	1942		770t, 50.0x8.4x3.4m, 1b,1vte, 850hp, 12.2kts, 40p; 1x1-76/40, 3x1-20/70, 4dct, 2dcr, sweeps; radar, sonar
		M354	Flatholm	1943		
		M429	Ronay	1945		
		M424	Sandray	1944		
		M356	Steepholm	1943		
		M427	Sursay	1945		
		M452	Tahay	1945		
		M432	Vaceasay	1945		
		M341	Wiay	1945		
103	M1101	Coniston	1953			
	M1102	Alcaston	1954			
	M1103	Alfriston	1954			
	M1104	Thames	1954			
	M1105	Amerton	1954			
	M1106	Appleton	1954			
	M1107	Beachampton	1956			
	M1108	Bevington	1954			
	M1109	Curzon	1954			
	M1110	Bildeston	1953			
	M1111	Edderton	1954			
	M1112	Boulston	1954			
	M1113	St. David	1954			
	M1114	Brinton	1954			
	M1115	Bronington	1954			
	M1116	Burnaston	1954			
	M1117	Buttington	1954			
	M1118	Calton	1955			
	M1119	Carhampton	1956			
	M1120	Caunton	1954			
	M1121	Chediston	1954			
	M1122	Chilcompton	1954			
	M1123	Clarbeston	1955			
	M1124	Clyde	1954			

	M1125	Cuxton	1954
	M1126	Dalswinton	1955
	M1127	Darlaston	1954
	M1128	Killiecrankie	1954
	M1129	Oulston	1955
	M1130	Highburton	1955
	M1131	Hickleton	1955
	M1132	Blaxton	1955
	M1133	Bossington	1956
	M1134	Essington	1955
	M1135	Fenton	1955
	M1136	Fittleton	1954
	M1137	Flockton	1954
	M1138	Floriston	1955
	M1139	Somerleyton	1955
	M1140	Gavinton	1954
	M1141	Glasserton	1954
	M1143	Hexton	1955
	M1145	Dufton	1955
	M1146	Northumbria	1954
	M1147	Hubberston	1955
	M1148	Ilmington	1954
	M1149	Badminton	1955
	M1150	Invermoriston	1955
	M1151	Iveston	1955
	M1152	Jackton	1955
	M1153	Kedleston	1955
	M1154	Kellington	1955
	M1155	Monkton	1956
	M1156	Kemerton	1954
	M1157	Kilmorey	1954
	M1158	Laleston	1954
	M1159	Lanton	1955
	M1160	Letterston	1955
	M1161	Leverton	1955
	M1162	Kildarton	1955
	M1163	Lullington	1956
	M1164	Maddiston	1956
	M1165	Maxton	1957
	M1166	Montrose	1957

MSC Ton



425t, 46.3x8.8x2.5m, 2d, 2500(M1101-1129,1141,1158)-3000(M1130-1140,1142-1157,1159-1216)hp, 15kts, 29p; 1x1-40/60, 1x2-20/70, sweeps; type 978 radar

M1167	Repton	1958
M1168	Dilston	1955
M1169	Penston	1955
M1170	Picton	1956
M1171	Aldington	1956
M1172	Thankerton	1957
M1173	Mersey	1958
M1174	Puncheston	1957
M1175	Quainton	1958
M1176	Rennington	1959
M1177	Rodington	1955
M1178	Santon	1956
M1179	Sefton	1955
M1180	Shavington	1956
M1181	Sheraton	1956
M1182	Shoulton	1955
M1183	Singleton	1956
M1184	Sullington	1954
M1185	Swanston	1955
M1186	Tarlton	1955
M1187	Upton	1956
M1188	Walkerton	1958
M1189	Wasperton	1956
M1192	Wilkieston	1957
M1193	Wolverton	1957
M1194	Woolaston	1958
M1195	Wotton	1957
M1196	Yarnton	1957
M1198	Ashton	1957
M1199	Belton	1956
M1200	Soberton	1957
M1202	Maryton	1959
M1203	Dartington	1957
M1204	Stubbington	1957
M1205	Wiston	1959
M1206	Fiskerton	1958
M1209	Chawton	1958
M1211	Houghton	1958
M1216	Crofton	1958
M2601	Inglesham	1953
M2603	Arlingham	1953

M2605	Bassingham	1953
M2608	Blunham	1953
M2609	Bodenham	1953
M2610	Boreham	1953
M2611	Bottisham	1953
M2613	Brigham	1953
M2614	Bucklesham	1954
M2615	Cardingham	1953
M2616	Chelsham	1953
M2617	Chillingham	1953
M2618	Cobham	1953
M2619	Darsham	1953
M2620	Davenham	1953
M2621	Dittisham	1954
M2622	Downham	1956
M2624	Elsenham	1956
M2625	Etchingham	1958
M2626	Everingham	1954
M2627	Felmersham	1954
M2628	Flintham	
M2629	Damerham	1954
M2630	Fritham	1954
M2631	Glentham	1958
M2632	Greetham	1955
M2633	Halsham	1954
M2634	Harpham	1954
M2635	Haversham	1954
M2636	Lasham	1954
M2637	Hovingham	1956
M2701	Cranham	1954
M2706	Ledsham	1955
M2708	Ludham	1956
M2710	Mickleham	1955
M2712	Neasham	1957
M2713	Nettleham	1958
M2714	Ockham	1958
M2716	Pagham	1956
M2717	Fordham	1956
M2721	Pulham	1956
M2722	Rackham	1956

Ham

66

MSI







159t, 32.5(M2601-2739)-32.8(M2777-2793)x6.4(M2601-2637)-6.6(M2701-2739)-6.7(M2777-2793)x1.7m, 2d, 1100hp, 14kts, 15p; 1x1-40/60 or 1x1-20/70, sweeps; type 978 radar

		M2723	Reedham	1958		
		M2726	Shipham	1956		
		M2727	Saxlingham	1957		
		M2728	Shrivenham	1956		
		M2729	Sidlesham	1955		
		M2733	Thakeham	1957		
		M2735	Tongham	1957		
		M2736	Tresham	1955		
		M2737	Warmingham	1956		
		M2777	Wintrigham	1955		
		M2778	Woldingham	1957		
		M2779	Wrentham	1955		
		M2780	Yaxham	1959		
		M2781	Portisham	1956		
		M2782	Popham	1955		
		M2783	Odiham	1956		
		M2784	Puttenham	1958		
		M2785	Birdham	1957		
		M2786	Rampisham	1957		
		M2787	Abbotsham	1957		
		M2788	Georgeham	1957		
		M2790	Thatcham	1958		
		M2791	Sandringham	1957		
		M2793	Thornham	1958		
		M2001	Dingley	1953		164t, 32.5x6.6x1.7m, 2d, 700hp, 13kts, 15p; 1x1-40/60 or 1x1-20/70, sweeps; type 978 radar
		M2002	Aveley	1953		
		M2003	Brearley	1953		
		M2004	Brenchley	1955		
Ley	9	M2005	Brinkley	1955		
		M2007	Watchful	1953		
		M2008	Squirrel	1954		
		M2009	Chailey	1955		
		M2010	Cradley	1955		

[home](#)[World navies yesterday](#)[1960](#)

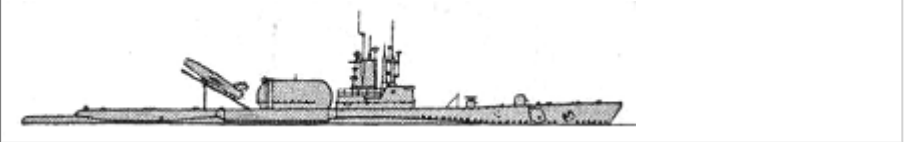
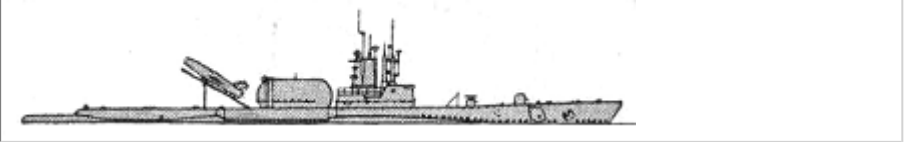
United States of America 01 January 1960

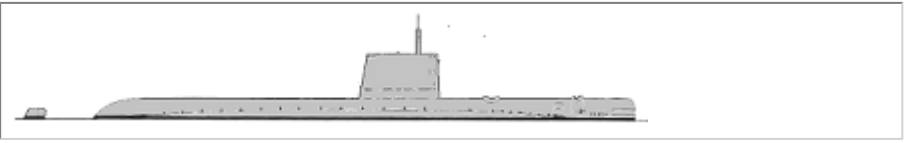
SUBMARINES

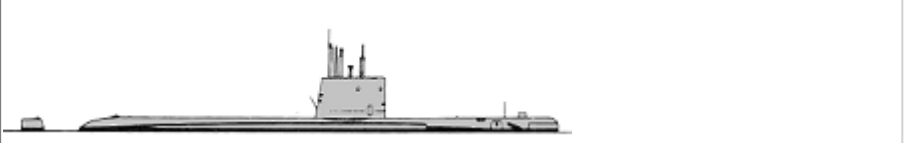
SSBN	George Washington	1	SSBN598	George Washington	1959		5959/6709t, 116.4x10.1x8.1m, 1nr,2gst(1), 15000hp, 16/22kts, 112p, 210m; 16PolarisA-1SLBM(16UGM-27A), 6-533TT(12); BPS-12 radar, BQS-4, BQR-2 sonars
SSG	Gato SSG	1	SSG282	Tunny	1942		1525/2400t, 95.1x8.3x4.7m, 3dg/4em(2), 3430/2740hp, 17/9kts, 84p, 90m; 2 Regulus I CruM launchers (2 RGM-6), 10-533TT(24); SS, SV-6, BPS-1, BPS-4 radars, BQR-2, BQS-2, JT sonars
	Balao SSG	2	SSG317	Barbero	1944		1830/2440t, 95.0x8.3x5.2m, 2dg/4em(2)(SSG317)-4dg/4em(2)(SSG337), 2305/2305hp(SSG317)-4610/2700(SSG337)hp, 15/9(SSG317)-20/10(SSG337)kts, 84p, 120m; 2RegulusI CruM(2RGM-6), 6-533TT(16)(SSG317), 10-533TT(24)(SSG337); SS, SV-6, BPS-1, BPS-4 radars, BQR-2, BQS-2, JT sonars
			SSG337	Carbonero	1945		
	Grayback	1	SSG574	Grayback	1958		2670/3638t, 98.3x9.1x5.3m, 3dg,2em, 4500/5600hp, 15/12kts, 84p, 210m; 2x1RegulusISSM(4SSM-N-8), 8-533TT(16?); BPS-12 radar, BQS-4, BQR-2 sonars
Growler	1	SSG577	Growler	1958		2174/3387t, 96.6x8.3x5.2m, 3dg,2em, 4600/5600hp, 15/12kts, 84p, 210m; 2x1RegulusdISSM(4SSM-N-8), 6-533TT(12?); BPS-12 radar, BQS-4, BQR-2 sonars	
SSN	Nautilus	1	SSN571	Nautilus	1955		3533/4092t, 98.7x8.4x6.6m, 1nr,2gst, 15000hp, 22/23kts, 105p, 210m; 6-533TT(22); BPS-12 radar, BQS-4, BQR-4A sonars
	Seawolf	1	SSN575	Seawolf	1957		3741/4287t, 102.9x8.4x6.7m, 1nr,2gst, 15000hp, 192/1kts, 105p, 210m; 6-533TT(22); BPS-12 radar, BQS-4, BQR-4A sonars
	Skate	4	SSN578	Skate	1957		2550/2848t, 81.6x7.6x6.3m, 1nr,2gst, 6600hp, 15.5/20kts, 84p, 210m; 8-533TT(22); BPS-12 radar, BQS-4, BQR-2 sonars
			SSN579	Swordfish	1958		
SSN583			Sargo	1958			
SSN584			Seadragon	1959			

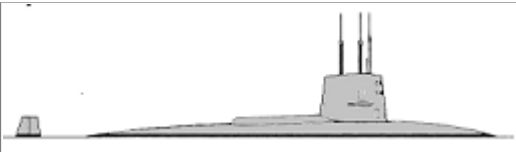
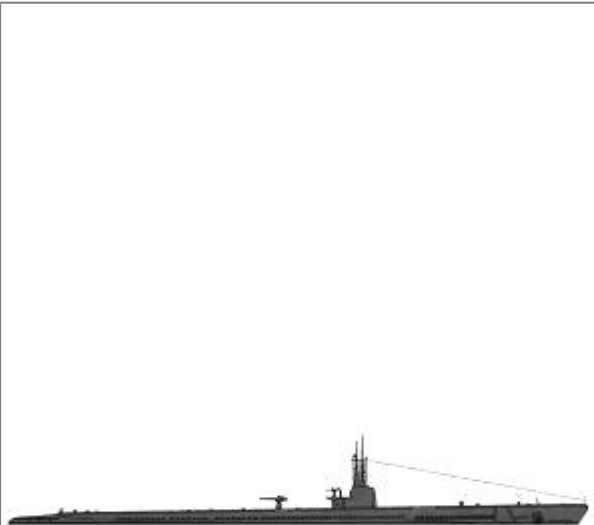
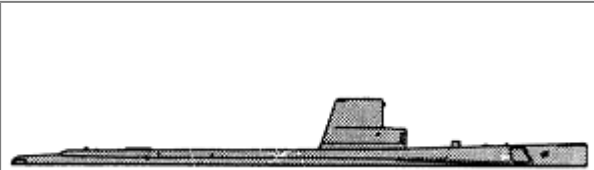
	Skipjack	1	SSN585	Skipjack	1959		3070/3500t, 76.8x9.7x7.7m, 1nr,2gst(1), 15000hp, 15/29kts, 85p, 210m; 6-533TT(24); BPS-12 radar, BQS-4, BQR-2B sonars
Gato	22	SS212	Gato	1941			1810/2410-1700/2600(SS272)t, 95.0-104.1(SS272)x8.3x4.7m, 4dg/4em(2), 5400/2740-4610/1750(SS272)hp, 20.2/8.7-17/8(SS272)kts, 60p, 90m; 1x1-127/25, 1x1-40/60, 1x1-20/70, 10-533TT(24), 6-533TT(18)(SS272), SS, ST, SV radars, sonar
		SS213	Greenling	1942			
		SS217	Guardfish	1942			
		SS224	Cod	1943			
		SS225	Cero	1943			
		SS228	Drum	1941			
		SS231	Haddock	1942			
		SS234	Kingfish	1942			
		SS235	Shad	1942			
		SS236	Silversides	1941			
		SS239	Whale	1942			
		SS245	Cobia	1944			
		SS254	Gurnard	1942			
		SS256	Hake	1942			
		SS258	Hoe	1942			
		SS264	Pargo	1943			
		SS265	Peto	1942			
		SS268	Puffer	1943			
		SS272	Redfin	1943			
		SS276	Sawfish	1942			
SS280	Steelhead	1942					
SS281	Sunfish	1942					
Gato SSK	6	SS240	Angler	1943			1848/2440t, 93.6x8.2x5.2m, 2dg/4em(2), 2305/5400hp, 14/15kts, 82p, 90m; 10-533TT(24); SS, SV, BPS-1 radars, BQR-2, BQS-2, SQR-3, BQR-4 sonars
		SS241	Bashaw	1943			
		SS242	Bluegill	1943			
		SS243	Bream	1944			
		SS244	Cavalla	1944			
		SS246	Croaker	1944			
		SS285	Balao	1943			
		SS286	Billfish	1943			
		SS287	Bowfin	1943			
		SS288	Cabrilla	1943			
		SS291	Crevalle	1943			
		SS292	Devilfish	1944			
		SS293	Dragonet	1944			
		SS295	Hackleback	1944			
SS297	Ling	1945					

Balao



46





SS298	Lionfish	1944
SS300	Moray	1945
SS301	Roncador	1945
SS304	Seahorse	1943
SS309	Aspro	1943
SS310	Batfish	1943
SS311	Archerfish	1943
SS321	Besugo	1944
SS328	Charr	1944
SS334	Cabazon	1944
SS335	Dentuda	1944
SS336	Capitaine	1945
SS342	Chopper	1945
SS348	Cusk	1946
SS372	Lambrey	1944
SS373	Lizardfish	1944
SS374	Loggerhead	1945
SS375	Macabi	1945
SS376	Mapiro	1945
SS378	Mero	1945
SS381	Sand Lance	1943
SS383	Pampanito	1943
SS384	Parche	1943
SS387	Pintado	1944
SS388	Pipefish	1944
SS389	Piranha	1944
SS390	Plaice	1944
SS393	Queenfish	1944
SS395	Redfish	1944
SS397	Scabbardfish	1944
SS400	Sea Devil	1944
SS401	Sea Dog	1944
SS404	Spikefish	1944
SS411	Spadefish	1944
SS412	Trepang	1944
SS413	Spot	1944
SS414	Springer	1944
SS339	Catfish	1945
SS343	Clamagore	1945
SS344	Cobbler	1945
SS346	Corporal	1945



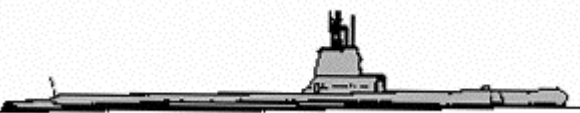
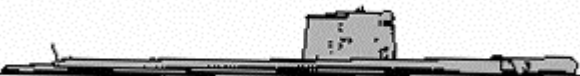
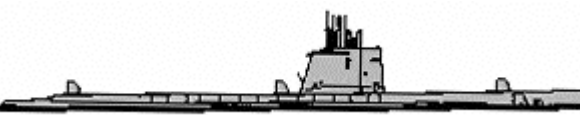

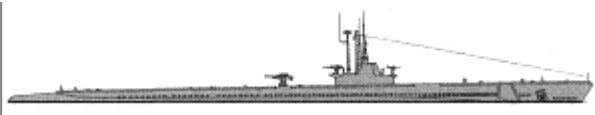

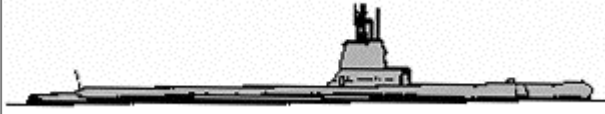
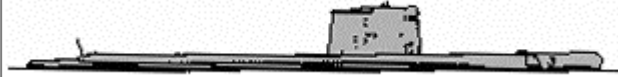
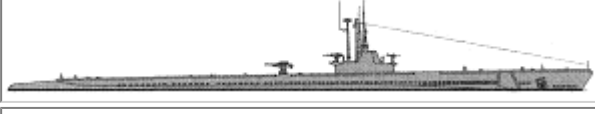



1845/2415t, 95.0x8.3x4.7m, 4dg/4em(2), 5400/2740hp, 20.2/8.7kts, 60p, 120m; 1x1-127/25, 1x1-40/60, 1x1-20/70, 10-533TT(24); SS, ST, SV radars, sonar

SS

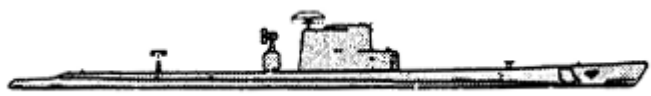
Balao GUPPY II	9	SS347	Cubera	1945		1870/2440t, 93.6x8.2x5.2m, 4dg/4em(2), 4610/5400hp, 18/16kts, 82p, 120m; 10-533TT(24); SS, ST, SV radars, BQR-2, BQS-2, JT or SQR-3 sonars
		SS349	Diodon	1946		
		SS350	Dogfish	1946		
		SS351	Greenfish	1946		
		SS352	Halfbeak	1946		
Balao Fleet Snorkel	11	SS302	Sabalo	1945		1830/2440t, 95.0x8.3x5.2m, 4dg/4em(2), 4610/2700hp, 20/10kts, 82p, 120m; 10-533TT(24); SS, ST, SV radars, BQR-2, BQS-2, SQR-3 sonars
		SS303	Sablefish	1945		
		SS307	Tilefish	1943		
		SS331	Bugara	1944		
		SS338	Carp	1945		
		SS392	Sterlet	1944		
		SS398	Segundo	1944		
		SS399	Sea Cat	1944		
		SS405	Sea Owl	1944		
		SS408	Sennet	1944		
		SS409	Piper	1944		
Balao GUPPY IA	8	SS319	Becuna	1944		1830/2440t, 93.6x8.2x5.2m, 4dg,4em(2), 4610/5400hp, 18/15kts, 82p, 120m; 10-533TT(24); SS, SV, BPS-1 radars, BQR-2, BQS-2, SQR-3 sonars
		SS322	Blackfin	1944		
		SS323	Caiman	1944		
		SS324	Blenny	1944		
		SS341	Chivo	1945		
		SS403	Atule	1944		
		SS406	Sea Poacher	1944		
		SS407	Sea Robin	1944		
Balao GUPPY IIA	11	SS340	Entemedor	1945		1848/2440t, 93.6x8.2x5.2m, 3dg/4em(2), 3430/5400hp, 17/15kts, 82p, 120m; 10-533TT(24); BPS-1, BPS-4, SS radars, BQR-2, BQS-2, SQR-3 sonars
		SS365	Hardhead	1944		
		SS368	Jallao	1944		
		SS377	Menhaden	1945		
		SS382	Picuda	1943		
		SS385	Bang	1943		
		SS391	Pomfret	1944		
		SS394	Razorback	1944		
		SS396	Ronquil	1944		
		SS402	Sea Fox	1944		
		SS410	Threadfin	1944		
Balao GUPPY III	1	SS416	Tiru	1948		1975/2450t, 99.5x8.2x5.2m, 4dg/4em(2), 4610/5400hp, 17.2/14.5kts, 86p, 120m; 10-533TT(24); BPS-1, BPS-4, BPS-5 radars, BQR-2, BQS-2, SQR-3, BQG-4 sonars
		SS422	Toro	1944		
		SS435	Corsair	1946		

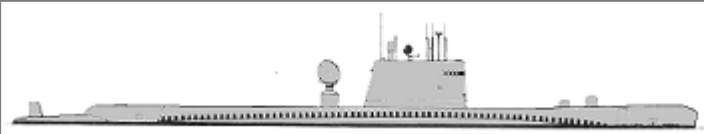
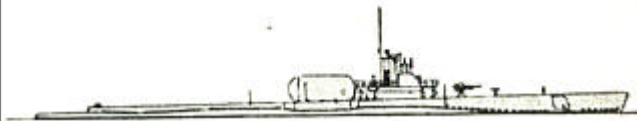
Tench	5	SS477	Conger	1945		1845/2415t, 95.0x8.3x4.7m, 4dg/4em(2), 5400/2740hp, 20.2/8.7kts, 60p, 120m(SS417-437)-135m(SS475-529); 1x1-127/25(SS417-437), 2x1-127/25(SS475-529), 1x1-40/60, 1x1-20/70, 10-533TT(24)(SS417-437), 10-533TT(28)(SS475-529); SS, ST, SV radars, sonars
		SS479	Diablo	1945		
		SS488	Sarda	1946		
Tench GUPPY II	13	SS425	Trumpetfish	1946		1870/2440t, 93.6x8.2x5.2m, 4dg/4em(2), 4610/5400hp, 18/16kts, 82p, 135m; 10-533TT(24); SS, ST, SV radars, BQR-2, BQS-2, JT or SQR-3 sonars
		SS426	Tusk	1946		
		SS478	Cutlass	1945		
		SS483	Sea Leopard	1945		
		SS484	Odax	1945		
		SS485	Sirago	1945		
		SS486	Pomodori	1945		
		SS487	Remora	1946		
		SS490	Volador	1948		
		SS522	Amberjack	1946		
		SS523	Grampus	1947		
		SS524	Pickerel	1949		
		SS525	Grenadier	1951		
Tench Fleet Snorkel	5	SS423	Torsk	1944		1830/2440t, 95.0x8.3x5.2m, 4dg/4em(2), 4610/2700hp, 20/10kts, 82p, 135m; 10-533TT(24); SS, ST, SV radars, BQR-2, BQS-2, SQR-3 sonars
		SS475	Argonaut	1945		
		SS476	Runner	1945		
		SS480	Medregal	1945		
		SS482	Irex	1945		
Tench GUPPY IA	1	SS417	Tench	1944		1830/2440t, 93.6x8.2x5.2m, 4dg/4em(2), 4610/5400hp, 18/15kts, 82p, 120m; 10-533TT(24); SS, SV, BPS-1 radars, BQR-2, BQS-2, SQR-3 sonars
Tench GUPPY IIA	4	SS418	Thornback	1944		1848/2440t, 93.6x8.2x5.2m, 3dg/4em(2), 3430/5400hp, 17/15kts, 82p, 120m; 10-533TT(24); BPS-1, BPS-4, SS radars, BQR-2, BQS-2, SQR-3 sonars
		SS420	Tirante	1944		
		SS421	Trutta	1944		
		SS424	Quillback	1944		
Tench Migraine II	2	SS481	Requin	1945		1570/2410t, 95.1x8.3x4.7m, 4dg/2em(2), 4610/1750hp, 17/8kts, 60p, 135m; 4-533TT(12); SS, SV, SV-2 radars, sonars
		SS489	Spinax	1946		
Barracuda	3	SST3	Barracuda	1951		765/1160t, 59.8x7.5x4.4m, 2dg,2em, 1125/1050hp, 13/8.5kts, 37p, 120m; 4-533TT(8); BPS-12 radar; BQR-3, BQR-4 sonars
		SS551	Bass	1951		
		SS552	Bonita	1952		
Tang	6	SS563	Tang	1951		1821/2500t, 84.8x8.3x5.2m, 3dg,2em, 4500/5600hp, 15.5/16kts, 83p, 210m; 8-533TT(26); BPS-12 radar, BQS-4, BQR-2 sonars
		SS564	Trigger	1952		
		SS565	Wahoo	1952		
		SS566	Trout	1952		
		SS567	Gudgeon	1952		

			SS568	Harder	1952		
	Mackerel	2	SST1	Mackerel	1953		303/347t, 40.0x4.1x3.7m, 2dg,1em, 250/380hp, 10/10.5kts, 14p, 65m; 1-533TT; JP, JT sonars
			SST2	Marlin	1953		
	Darter	1	SS576	Darter	1956		1872/2372t, 86.7x8.3x5.1m, 3dg,2em, 3100/4700hp, 15.5/16kts, 83p, 210m; 8-533TT(26); BPS-12 radar, BQS-4, BQR-2 sonars
	Barbel	3	SS580	Barbel	1959		2146/2639t, 66.8x8.8x6.3m, 3dg,1em, 3150/4700hp, 14/18.5kts, 77p, 210m; 6-533TT(22); BPS-12 radar, BQS-4, BQR-2 sonars
			SS581	Blueback	1959		
			SS582	Bonefish	1959		
SSRN	Triton	1	SSRN586	Triton	1959		5963/7773t, 136.4x11.3x7.2m, 2nr,2gst, 34000hp, 27/20kts, 180p, 210m; 6-533TT(15); BPS-2, SPS-26, BPS-12 radars, BQS-4, BQR-2 sonars
	Gato Migraine III	4	SSR267	Pompon	1943		1700/2600t, 104.1x8.3xm, 4dg,2em(2), 4610/1750hp, 17/8kts, 108p, 90m; 6-533TT(18); BPS-2, BPS-3, BPS-4 radars, sonars
			SSR269	Rasher	1943		
			SSR270	Raton	1943		
			SSR271	Ray	1943		
	Balao Migraine I	1	SSR312	Burrfish	1943		1525/2410t, 95.1x8.3x4.7m, 4dg/2em(2), 4610/1750hp, 17/8kts, 120p, 120m; 1x1-40/60, 4-533TT(12); SS, SV-1, SV-2, BPS-2 radars, sonar
	Tench Migraine I	1	SSR419	Tigrone	1944		1525/2410t, 95.1x8.3x4.7m, 4dg/2em(2), 4610/1750hp, 17/8kts, 60p, 120m; 1x1-40/60, 4-533TT(12); SS, SV-1, SV-2, BPS-2 radars, sonars
	Sailfish	2	SSR572	Sailfish	1956		2625/3168t, 106.9x8.9x5.0m, 4dg,2em, 6000/8200hp, 19.5/10kts, 95p; 6-533TT(18); BPS-2, BPS-3 radars; BQS-2, BQR-2B sonars
			SSR573	Salmon	1956		
SSL	Balao	2	APSS313	Perch	1944		1845/2415t, 95.0x8.3x4.7m, 2dg/4em(2), 2700/2740hp, 20.2/8.7kts, 60p, 120m; 6-533TT(18), helicopter deck(SSP315); marines and vehicles; SS, ST, SV radars, sonar
			APSS315	Sealion	1944		
SSX	X1	1	X1		1955		31/36t, 15.0x2.1x1.9m, 1d/em, 30/30hp, 15/12kts, 4p; 4swimmers

AIRCRAFT CARRIERS

	Essex SCB-125	8	CVA9	Essex	1942		44000t, 277.6x47.9x9.6m, 8b,4gst, 150000hp, 30.3kts, 3050p; 37belt, 102decks; 4x1-127/38, 2catapults, 80aircraft(FJ, F2H, F9F, F3H, F4D, F11F, F8U fighters, AD, AJ, A3D, A4D attackers, F9F-P, OE, A3D-P, F8U-P recon, S2F ASW, AD-Q, AM-Q, F3D-Q, A3D-Q ECM, AD-W, WF EW, TF cargo, HO4S, HRS, HUP, HUP-S, HSS, HUS,
			CVA11	Intrepid	1943		
			CVA14	Ticonderoga	1944		
			CVA16	Lexington	1943		
			CVA19	Hancock	1944		
			CVA31	Bon Homme Richard	1944		
			CVA34	Oriskany	1950		

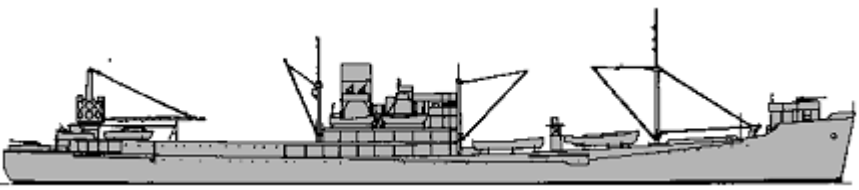
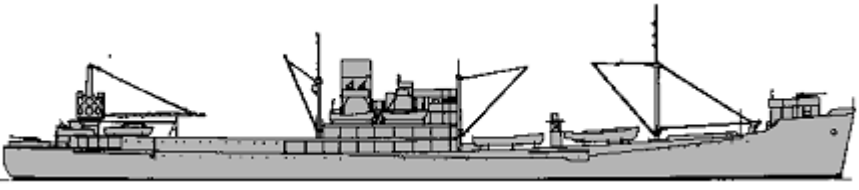
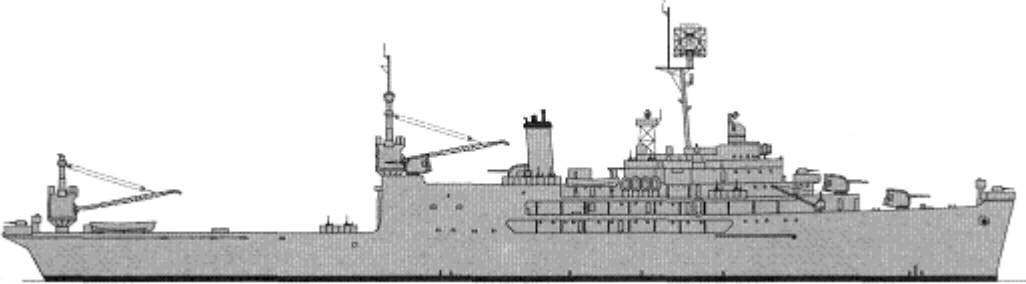
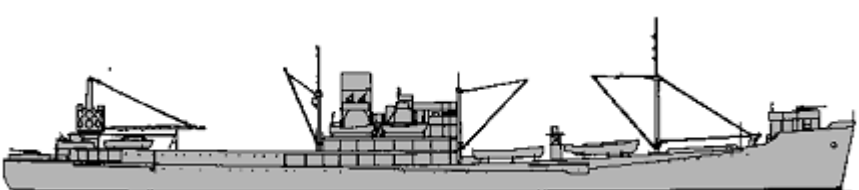
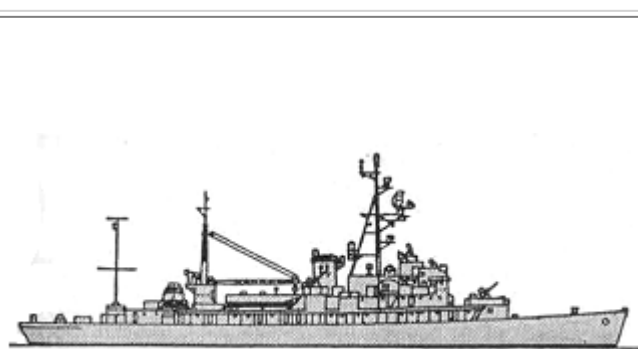

CVS	Essex CVS	3	CVS45	Valley Forge	1946	A detailed line drawing of the USS Valley Forge (CVS-45), an Essex-class transport aircraft carrier, shown from a starboard profile view. The ship features a large deck with various structures, masts, and antennas.	17x4-40/60(CV17)18x4-40/60(CV40, 45), 35x2-20/70(CV17), (16x2+23x1)-20/70(CV40, 45), 2catapults, 91aircraft (FJ, F2H, F9F, F3H, F4D, F11F, F8U fighters, AD, AJ, A3D, A4D attackers, F9F-P, OE, A3D-P, F8U-P recon, S2F ASW, AD-Q, AM-Q, F3D-Q, A3D-Q ECM, AD-W, WF EW, TF cargo, HO4S, HRS, HUP, HUP-S, HSS, HUS, HOK, HUK, HUL, HR2S helicopters); SG, SK-2, SR, SP, 2x Mk 12/22 radars
	Essex CVS SCB-27A	1	CVS39	Lake Champlain	1945	A detailed line drawing of the USS Lake Champlain (CVS-39), an Essex-class transport aircraft carrier, shown from a starboard profile view. The ship has a similar design to the Valley Forge but with a slightly different superstructure.	40600t, 273.8x46.3x9.1m, 8b,4gst, 150000hp, 30kts, 2905p; 37belt, 102decks; 8x1-127/38, 14x2-76/50, 2catapults, 80aircraft (FJ, F2H, F9F, F3H, F4D, F11F, F8U fighters, AD, AJ, A3D, A4D attackers, F9F-P, OE, A3D-P, F8U-P recon, S2F ASW, AD-Q, AM-Q, F3D-Q, A3D-Q ECM, AD-W, WF EW, TF cargo, HO4S, HRS, HUP, HUP-S, HSS, HUS, HOK, HUK, HUL, HR2S helicopters); SPS-6, SR, SPS-8, Mk35 radars
	Essex CVS SCB-125	7	CVS10	Yorktown	1943	A detailed line drawing of the USS Antietam (CVS-36), an Essex-class transport aircraft carrier, shown from a starboard profile view. The ship is the largest of the group shown, with a prominent superstructure and multiple masts.	44000t, 277.6x47.9x9.6m, 8b,4gst, 150000hp, 30.3kts, 3050p; 37belt, 102decks; 4x1-127/38, 2catapults, 80aircraft (FJ, F2H, F9F, F3H, F4D, F11F, F8U fighters, AD, AJ, A3D, A4D attackers, F9F-P, OE, A3D-P, F8U-P recon, S2F ASW, AD-Q, AM-Q, F3D-Q, A3D-Q ECM, AD-W, WF EW, TF cargo, HO4S, HRS, HUP, HUP-S, HSS, HUS, HOK, HUK, HUL, HR2S helicopters); SPS-8, SPS-12, SR radars
		CVS12	Hornet	1943			
		CVS15	Randolph	1944			
		CVS18	Wasp	1943			
		CVS20	Bennington	1944			
		CVS33	Kearsarge	1946			
		CVS36	Antietam	1945			
Curtiss	2	AV4	Curtiss	1940	A detailed line drawing of the USS Albermarle (AV-5), a Curtiss-class transport aircraft carrier, shown from a starboard profile view. The ship has a more compact design than the Essex-class carriers.	14900t, 160.7x21.1x6.5m, 4b,2gst, 12000hp, 18kts, 1195p; 4x1-127/38, 4x4-40/60, 12x1-20/70, helicopters(HO4S, HRS, HUP, HUP-S, HSS, HUS, HOK, HUK, HUL, HR2S), radars	
		AV5	Albermarle	1940			
Tangier	2	AV8	Tangier	1940	A detailed line drawing of the USS Pocomoke (AV-9), a Tangier-class transport aircraft carrier, shown from a starboard profile view. The ship is smaller than the Curtiss-class carriers.	13500t, 150.0x21.2x7.2m, 2b,1gst, 8500hp, 16.5kts, 1075p; 4x1-127/38, 4x1-76/50, 4x2-40/60, 15x1-20/70, helicopters(HO4S, HRS, HUP, HUP-S, HSS, HUS, HOK, HUK, HUL, HR2S), radars	
		AV9	Pocomoke	1941			

AV							
	Chandeleur	1	AV10	Chandeleur	1942		13700t, 150.0x21.2x7.2m, 2b,1gst, 9350hp, 17kts, 1077p; 1x1-127/38, 4x1-76/50 4x2-40/60, 15x1-20/70, helicopters(HO4S, HRS, HUP, HUP-S, HSS, HUS, HOK, HUK, HUL, HR2S), radars
	Currituck	3	AV7	Currituck	1944		15092t, 164.7x21.1x6.8m, 4b,2gst, 12000hp, 19.2kts, 1247p; 4x1-127/38, 4x4-40/60, helicopters(HO4S, HRS, HUP, HUP-S, HSS, HUS, HOK, HUK, HUL, HR2S), SK radar
			AV12	Pine Island	1945		
			AV13	Salisbury Island	1945		
	Kenneth Whiting	4	AV14	Kenneth Whiting	1944		12610t, 150.0x21.2x7.2m, 2b,1gst, 8500hp, 16.5kts, 1077p; 2x1-127/38, (2x4+2x2)-40/60, 16x1-20/70, helicopters(HO4S, HRS, HUP, HUP-S, HSS, HUS, HOK, HUK, HUL, HR2S), SK radar
			AV15	Hamlin	1944		
AV16			St. George	1944			
AV17			Cumberland Sound	1944			
Barnegat	10	AVP37	Corson	1944		2620t, 94.7x12.5x3.8m, 4dg,2em, 6080hp, 20kts, 367p; 1x1-127/38, 1x4-40/60(AVP10,48-55), (1x4+2x2)-40/60(AVP37-41), 4x2-20/70(AVP10,48-55), 6x1-20/70(AVP37-41), 2DCT, 2DCR, helicopters(HO4S, HRS, HUP, HUP-S, HSS, HUS, HOK, HUK, HUL, HR2S); SA, SU radars, sonar	
		AVP38	Duxbury Bay	1944			
		AVP40	Floyds Bay	1945			
		AVP41	Greenwich Bay	1945			
		AVP48	Onslow	1943			
		AVP49	Orca	1944			
		AVP52	Shelikof	1944			
		AVP53	Suisun	1944			
		AVP54	Timbalier	1946			
AVP55	Valcour	1946					



PRINCIPAL SURFACE COMBATANTS

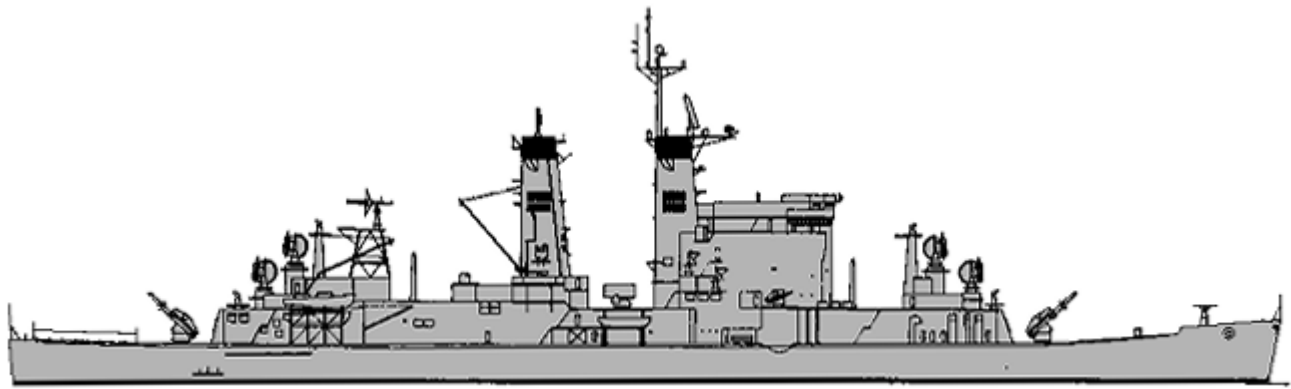
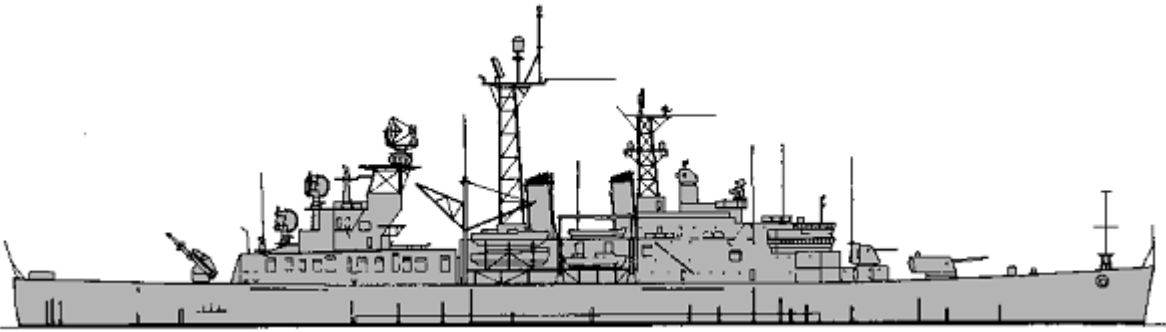
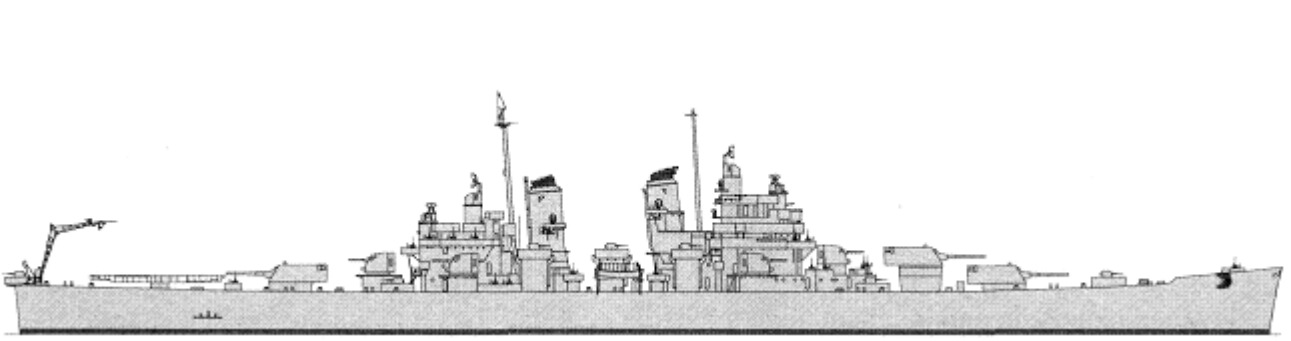

			BB55	North Carolina	1941	
	Noth	2				46700-46796t, 222.1x33.0x10.0m, 8b,4gst, 121000hp, 28kts, 1880p; 305belt, 193deck, 406turrets, 406CT; 3x3-406/45, 10x2-127/38, 24x4-40/60(BB55), 15x4-40/60(BB56),

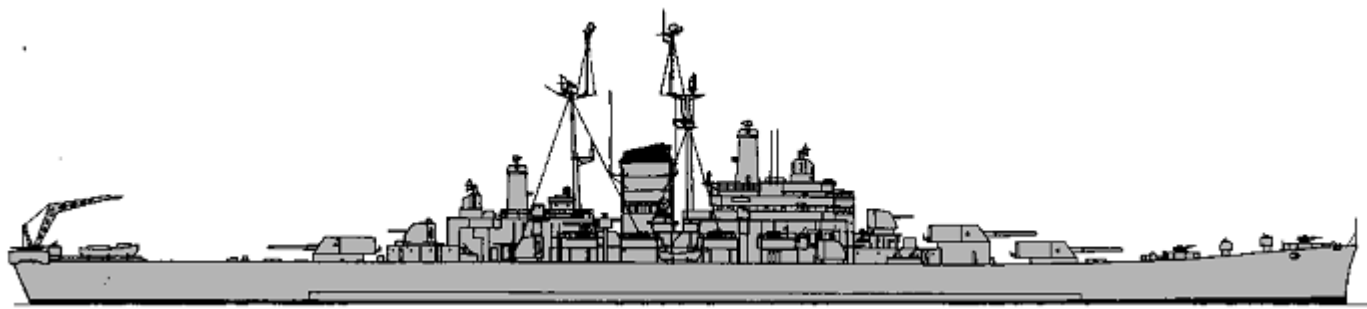
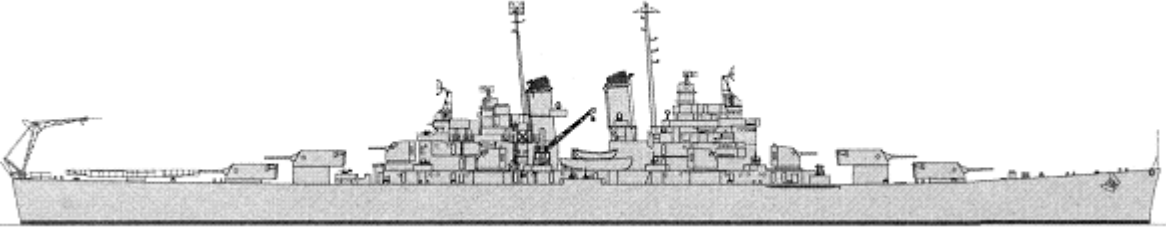
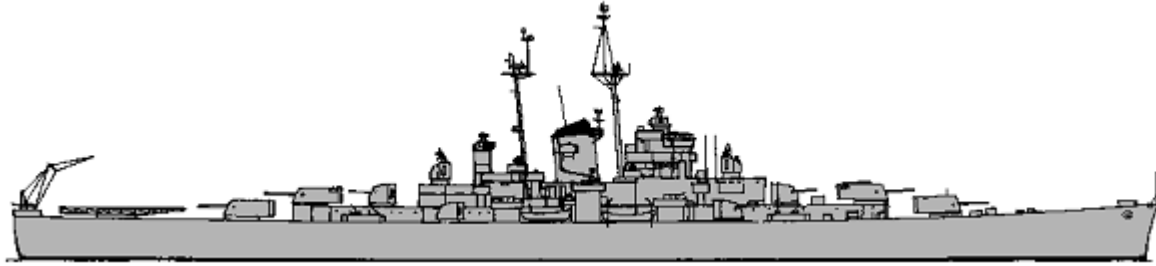
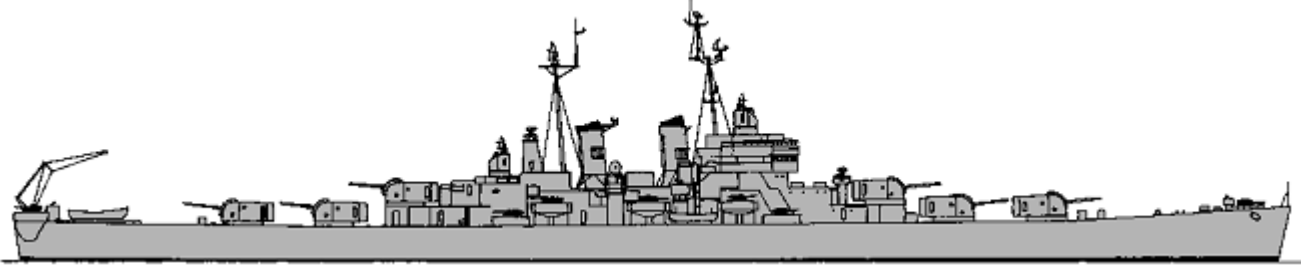
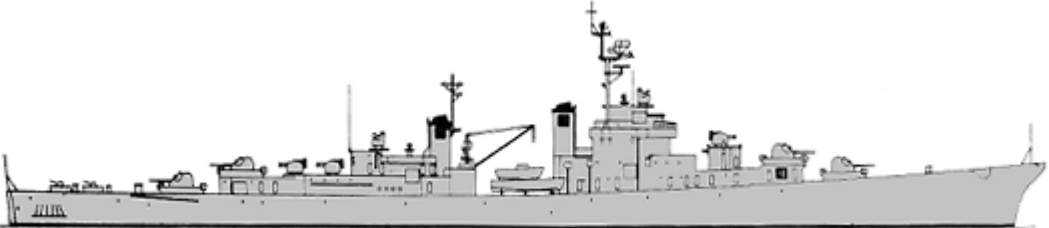
BB	Carolina	BB56	Washington	1941		(8x2+20x1)-20/70(BB55), (1x4+8x2+63x1)-20/70(BB56); 2x SG, SK-2(BB55), SK(BB56), SR, SCR-720, Mk3, Mk4, 2x Mk8, 3x Mk12/22, Mk27 radars	
	South Dakota	4	BB57	South Dakota	1942		44519t, 207.3x33.0x10.7m, 8b,4gst, 130000hp, 27.5kts, 1793p; 310belt, 203decks, 457turrets, 406CT; 3x3-406/45, 8x2-127/38(BB57), 10x2-127/38(BB58-60), 17x4-40/60(BB57), 12x4-40/60(BB58,60), 18x4-40/60(BB59), 77x1-20/70(BB57), (4x2+44x1)-20/70(BB58), (1x4+1x2+31x1)-20/70(BB59), 56x1-20/70(BB60); 2x SG, SK-2, SU, 2x Mk13, 4x Mk12/22, Mk27 radars
			BB58	Indiana	1942		
			BB59	Massachusetts	1942		
			BB60	Alabama	1942		
	Iowa	4	BB61	Iowa	1943		57540t, 270.4x33.0x11.0m, 8b,4gst, 212000hp, 32.5kts, 1921p; 307belt, 229decks, 495turrets, 440CT; 3x3-406/50, 10x2-127/38, 14x4-40/60, 3helicopters (HO4S, HRS, HUP, HUP-S, HO5S, HSL); 2x SG, SK(BB61,64), SK-2(BB62,63), SP(BB62), SR(BB61,64), SU(BB61,62), SPS-6, Mk3(BB61,62), 2x Mk8(BB63), 2x Mk13(BB61,62,64), 4x Mk12/22, Mk27(BB63,64) radars
			BB62	New Jersey	1943		
			BB63	Missouri	1944		
			BB64	Wisconsin	1944		
	CB	Alaska	2	CB1	Alaska	1944	
CB2				Guam	1944		
CG	Boston	2	CAG1	Boston	1943		17947t, 205.3x21.3x7.6m, 4b,4gst, 120000hp, 33kts, 1544p; 152belt, 64deck, 203turrets; 2x2TerrierSAM(144RIM-2), 2x3-203/55, 5x2-127/38, 4x2-76/50; SPS-6, SPS-8, SPS-12, CXRX, 2x Mk25(CAG1), 2x SPQ-5(CAG2) radars
			CAG2	Canberra	1943		
	Albany	3	CG10	Albany	1946		18777t, 205.8x21.3x7.9m, 4b,4gst, 120000hp, 32kts, 1266p; 152belt, 64deck; 2x2TalosSAM(104RIM-8), 2x2TartarSAM(84RIM-24), 1x8ASROCASR(8RUR-5), 2x1-127/38, 2x3-324TT; SPS-29, 2xSPS-30, SPS-39, 4xSPG-49/SPW-2, 4xSPG-51 radars, SQS-23
			CG11	Chicago	1945		
			CG12	Columbus	1945		

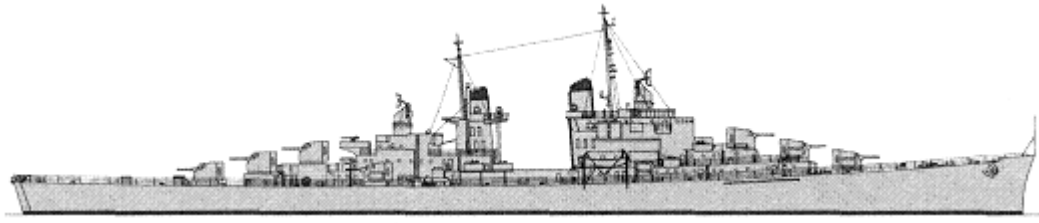
						sonar
	Galveston 6	CLG3	Galveston	1958		15152t, 186.0x20.2x7.8m, 4b,4gst, 100000hp, 32kts1382p; 127belt, 51deck, 165turrets; 1x2TalosSAM(46RIM-8)(CLG3-5), 1x2TerrierSAM(120RIM-2)(CLG6-8), 2x3-152/47(CLG3,6), 1x3-152/47(CLG4,5,7,8), 3x2-127/38(CLG3,6), 1x2-127/38(CLG4,5,7,8), helopad(CLG4,5,7,8); SPS-2(CLG4), SPS-8B(CLG3,5-8), SPS-9(CLG3,5-8), SPS-17(CLG4), SPS-39, 2xSPG-49/SPW-2(CLG3-5), 2xSPQ-5(CLG6-8) radars
		CLG4	Little Rock	1945		
		CLG5	Oklahoma City	1944		
		CLG6	Providence	1945		
		CLG7	Springfield	1944		
		CLG8	Topeka	1944		
CA	Baltimore 10	CA68	Baltimore	1943		17031t, 205.3x21.6x7.3m, 4b,4gst, 120000hp, 33kts, 2039p; 152belt, 64deck, 203turrets, 152CT(CA74-136); 3x1RegulusISSM(3RGM-6)(CA75,132,133,135), 3x3-203/55, 6x2-127/38, 10x2-76/50(CA68,71-73,130,131), 9x2-76/50(CA75), 7x2-76/50(CA132,133,135); SG-3, SK-2, SP, Mk13, 2x Mk12/22 radars
		CA71	Quincy	1943		
		CA72	Pittsburgh	1944		
		CA73	St. Paul	1945		
		CA75	Helena	1945		
		CA130	Bremerton	1945		
		CA131	Fall River	1945		
		CA132	Macon	1945		
		CA133	Toledo	1946		
		CA135	Los Angeles	1945		
	Oregon City 2	CA122	Oregon City	1946		17031t, 205.3x21.6x7.3m, 4b,4gst, 120000hp, 33kts, 2039p; 152belt, 64deck, 203turrets, 152CT; 3x3-203/55, 6x2-127/38, (11x4+2x2)-40/60, 10x2-20/70; SG-3, SK-2, SP, Mk13, 2x Mk12/22 radars
		CA124	Rochester	1946		
	Des Moines 3	CA134	Des Moines	1948		20934t, 218.4x23.0x7.9m, 4b,4gst, 120000hp, 33kts, 1799p; 152belt, 120decks, 203turrets, 165bridge; 3x3-203/55, 6x2-127/38, 11x2-76/50; SG-6, SK-3, SP, SPS-6, 2x Mk13, 4x Mk25, 3x Mk27 radars
		CA139	Salem	1949		
		CA148	Newport News	1949		

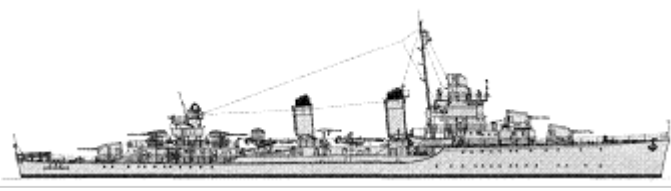
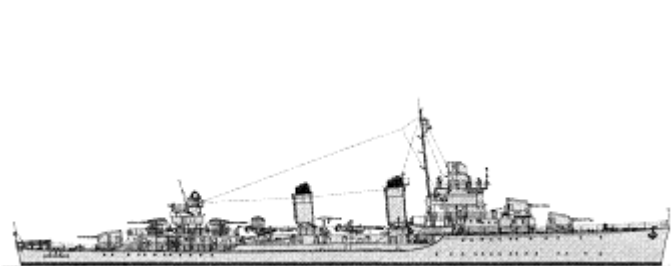
							
CL	Cleveland	14	CL58	Denver	1942		14144t, 186.0x20.2x7.5m, 4b,4gst, 100000hp, 32.5kts, 1285p; 127belt, 51deck, 165turrets, 127CT(CL58-63); 4x3-152/47, 6x2-127/38, (4x4+4x2)-40/60(CL58,64,65,80), (4x4+6x2)-40/60(CL83,86,87,89,90,101-105), 17x1-20/70(CL58), 21x1-20/70(CL64,65,80), 10x1-20/70(CL83,86,87,89,90,101-105); SC(CL58,65), SG(CL58,64,65,80,83,86,87,89,90,101-105), SK(CL89), SK-2(CL64,80,83,86,87,90,101-105), Mk8 (CL58,65), Mk13(CL64,80,83,86,87,89,90,101-105), 2x Mk12/22(CL58,65,89), 2x Mk25(CL64,80,83,86,87,90,101-105) radars
			CL64	Vincennes	1944		
			CL65	Pasadena	1944		
			CL80	Biloxi	1943		
			CL83	Manchester	1946		
			CL86	Vicksburg	1944		
			CL87	Duluth	1944		
			CL89	Miami	1943		
			CL90	Astoria	1944		
			CL101	Amsterdam	1945		
			CL102	Portsmouth	1945		
			CL103	Wilkes-Barre	1944		
			CL104	Atlanta	1944		
			CL105	Dayton	1945		
CL	Fargo	2	CL106	Fargo	1945		14464t, 186.0x20.2x7.5m, 4b,4gst, 100000hp, 32.5kts, 1285p; 127belt, 51deck, 165turrets; 4x3-152/47, 6x2-127/38, (6x4+2x2)-40/60, 14x2-20/70; SG, SK-2, Mk13, 2x Mk25 radars
			CL107	Huntington	1946		
CL	Worcester	2	CL144	Worcester	1948		17997t, 207.1x21.5x7.5m, 4b,4gst, 120000hp, 33kts, 1401p; 127belt, 124deck, 165turrets, 127CT; 6x2-152/47, (11x2+2x1)-76/50; SR-2, SR-6, SPS-8, 2x Mk13, 4x Mk28, 4x Mk35 radars
			CL145	Roanoke	1949		
CL	Norfolk	1	DL1	Norfolk	1953		8315t, 164.6x16.3x5.8m, 4b,2gst, 80000hp, 33kts, 546p; 4x2-76/70, 8-533TT, 4x1-324WeaponAlfa; SPS-6, SPS-26 radars, SQS-4 sonar

CLAA	Atlanta	2	CLAA97	Flint	1944		8100t, 165.1x16.2x6.2m, 4b,2gst, 75000hp, 32.5kts, 623p; 95belt, 32deck, 32turrets; 6x2-127/38, 8x2-40/60, 16x1-20/70, 2x4-533TT(CLAA97); SC, SG, 2x Mk12/22 radars
			CLAA98	Tucson	1945		
CLAA	Juneau	2	CLAA120	Spokane	1946		8450t, 165.1x16.2x6.2m, 4b,2gst, 75000hp, 32.5kts, 623p; 95belt, 32deck, 32turrets, 63CT; 6x2-127/38, (6x4+4x2)-40/60, 8x2-20/70; SC, SG, 2x Mk12/22 radars
			CLAA121	Fresno	1946		
DDG	Gyatt	1	DDG1	Gyatt	1945		3460t, 119.0x12.5x4.4m, 4b,2gst, 60000hp, 36.8kts, 336p; 1x2TerrierSAM(24RIM-8), 2x2-127/38, 2x2-76/50, 4x1-2./7/90; SPS-6, SPS-10 radars, QHB sonar
			Farragut	1	DLG14	Dewey	1959
	Benson	3	DD422	Mayo	1940		2572t, 106.2x11.0x4.0m, 4b,2gst, 50000hp, 35kts, 208p; 4x1-127/38, 2x2-40/60, 4x1-20/70, 2x5-533TT, 6DCT, 2DCR, radars, sonar
			DD425	Madison	1940		
			DD428	Charles F. Hughes	1940		
	Gleaves	9	DD423	Gleaves	1940		2591t, 106.2x11.0x4.0m, 4b,2gst, 50000hp, 35kts, 208p; 4x1-127/38, (2x4+2x2)-40/60(DD423,424,432,435,437,439,440,443), 2x2-40/60(DD441), 2x2-20/70(DD423,424,432,435,437,439,440,443), 4x1-20/70(DD441), 2x5-533TT(DD441), 6DCT, 2DCR, radars, sonar
			DD424	Niblack	1940		
			DD432	Kearny	1940		
			DD435	Grayson	1941		
			DD437	Woolsey	1941		
			DD439	Edison	1941		
			DD440	Ericsson	1941		
	DD441	Wilkes	1941				
	DD443	Swanson	1941				
			DD455	Hambleton	1941		
			DD462	Fitch	1942		
			DD489	Mervine	1942		

Bristol DMS	16	DD490	Quick	1942		2600t, 106.2x11.0(DD455,462,489,490,493-496,618,621,627,632,633,637)-11.3(DD634,635)x4.9m, 4b,2gst, 50000hp, 35kts, 208p; 3x1-127/38, 2x2-40/60(DD455,462,621,637), (2x4+2x2)-40/60(DD489,490,493-496,618,627,632-635), 7x1-20/70(DD455,462,621,637), (2x2+2x1)-20/70(DD489,490,493-496,618,627,632-635), 2DCT, 2DCR, sweeping gear; radars, sonar
		DD493	Carmick	1942		
		DD494	Doyle	1943		
		DD495	Endicott	1943		
		DD496	McCook	1943		
		DD618	Davison	1942		
		DD621	Jeffers	1942		
		DD627	Thompson	1943		
		DD632	Cowie	1942		
		DD633	Knight	1942		
		DD634	Doran	1942		
		DD635	Earle	1942		
		DD637	Gherardi	1942		
Bristol	11	DD497	Frankford	1943		2600t, 106.2x11.0x4.9m, 4b,2gst, 50000hp, 35kts, 208p; 4x1-127/38, (2x4+2x2)-40/60(DD497,623,624,628), 2x2-40/60(DD619,626,638,641,645-647), (2x2+2x1)-20/70(DD497,623,624,628), 7x1-20/70(DD619,626,638,641,645-647), 1x5-533TT(DD619,626,638,641,645-647), 6DCT, 2DCR; radars, sonar
		DD619	Edwards	1942		
		DD623	Nelson	1942		
		DD624	Baldwin	1943		
		DD626	Satterlee	1943		
		DD628	Welles	1943		
		DD638	Herndon	1942		
		DD641	Tillman	1942		
		DD645	Stevenson	1942		
		DD646	Stockton	1943		
		DD647	Thorn	1943		
Laffey	21	DD491	Farenholt	1942		2600t, 106.2x11.0x4.9m, 4b,2gst, 50000hp, 35kts, 208p; 4x1-127/38, 2x2-40/60(DD491,492,598,602,605-607, 609,611), (2x4+2x2)-40/60(DD600,601,603,604,608,610, 612-614,616,617), 4x2-40/60(DD615), 7x1-20/70(DD491,492,598,602,605-607,609,611), (2x2+2x1)-20/70(DD600,601, 603,604,608,610,612-617), 1x5-533TT(DD491,492,598,602,605-607, 609,611), 6DCT, 2DCR; radars, sonar
		DD492	Bailey	1942		
		DD598	Bancroft	1942		
		DD600	Boyle	1942		
		DD601	Champlin	1942		
		DD602	Meade	1942		
		DD603	Murphy	1942		
		DD604	Parker	1942		
		DD605	Caldwell	1942		
		DD606	Coghlan	1942		
		DD607	Frazier	1942		
		DD608	Gansevoort	1942		
		DD609	Gillespie	1942		
		DD610	Hobby	1942		
		DD611	Kalk	1942		
DD612	Kendrick	1942				
DD613	Laub	1942				

DD614	Mackenzie	1942
DD615	McLanahan	1942
DD616	Nields	1943
DD617	Ordronaux	1943
DD448	La Vallette	1942
DD474	Fullam	1943
DD475	Hudson	1943
DD478	Stanly	1942
DD479	Stevens	1943
DD480	Halford	1943
DD501	Schroeder	1943
DD502	Sigsbee	1943
DD511	Foote	1942
DD513	Terry	1943
DD519	Daly	1943
DD520	Isherwood	1943
DD521	Kimberly	1943
DD527	Ammen	1943
DD528	Mullany	1943
DD530	Trathen	1943
DD531	Hazelwood	1943
DD532	Heermann	1943
DD534	McCord	1943
DD535	Miller	1943
DD536	Owen	1943
DD537	The Sullivans	1943
DD538	Stephen Potter	1943
DD539	Tingey	1943
DD540	Twining	1943
DD541	Yarnall	1943
DD544	Boyd	1943
DD545	Bradford	1943
DD546	Brown	1943
DD547	Cowell	1943
DD553	John D. Henley	1943
DD554	Franks	1943
DD556	Hailey	1943
DD558	Laws	1943
DD561	Prichett	1944
DD562	Robinson	1944

Fletcher 118

DD563	Ross	1944
DD564	Rowe	1944
DD565	Smalley	1944
DD566	Stoddard	1944
DD567	Watts	1944
DD568	Wren	1944
DD570	Charles Ausburne	1942
DD572	Dyson	1942
DD573	Harrison	1943
DD574	John Rodgers	1943
DD575	McKee	1943
DD578	Wickes	1943
DD580	Young	1943
DD583	Hall	1943
DD585	Haraden	1943
DD587	Bell	1943
DD588	Burns	1943
DD589	Izard	1943
DD590	Paul Hamilton	1943
DD592	Howorth	1944
DD593	Killen	1944
DD594	Hart	1944
DD595	Metcalfe	1944
DD596	Shields	1945
DD597	Wiley	1945
DD629	Abbot	1943
DD630	Braine	1943
DD631	Erben	1943
DD642	Hale	1943
DD643	Sigourney	1943
DD644	Stembel	1943
DD649	Albert W. Grant	1943
DD650	Caperton	1943
DD651	Cogswell	1943
DD652	Ingersoll	1943
DD653	Knapp	1943
DD654	Bearss	1944
DD655	John Hood	1944
DD656	Van	1944

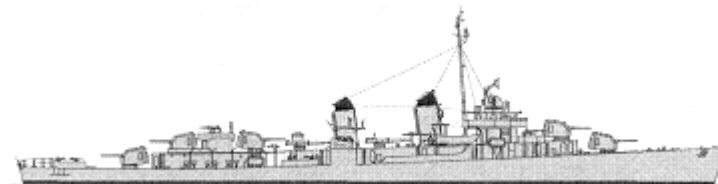

3005t, 114.7x12.1x4.2m, 4b,2gst, 60000hp, 38kts, 273p; 5x1-127/38(DD448,474,475,478-480,501,502,511,513, 521,531,534,536, 539-541,545,546,553,554, 558,562, 563,565,567,568,570,572-575,578,580,583, 585, 587-590,592-597,631,643,649, 653,654,656-658, 660-662,665,667,668,671-673, 675,676,680,682-684 ,686,688,690, 691,797,798,800,802), 4x1-127/38(DD519,520,527,528, 530,532, 535,537,538,544,547,556,561, 564,566,629,630,642, 644,650-652,655,659,666,669, 670, 674,677-679,681,685,687,689,793-796,799,804), 3x2-76/50(DD519,520,527,528,530,532, 535,537,538,544,547, 556,561,564,566, 629,630,642,644,650-652,655,659,666,669,670,674,677-679,681,685,687,689,793-796,799,804), (2x4+3x2)-40/60(DD448, 478, 521, 531, 534,536,539,540, 554, 563, 578, 580, 589, 592, 643, 657, 661, 665, 668, 671-673,675, 676, 682, 686, 800, 802), 5x2-40/60(DD474, 475, 479, 480, 501, 511, 513, 541, 545,546, 553, 558, 562, 565, 567, 568,570,572-575, 583, 585, 587, 588, 590, 593-597, 631, 649,653,654, 656, 658,660, 662, 667, 680, 683, 684, 688,690,691, 797,798), (4x2+3x1)-20/70(DD448, 478, 521, 531, 534, 536,539,540, 554, 563, 578, 580, 589, 592, 643, 657, 661, 665, 668, 671-673,675,676, 682, 686, 800, 802), 7x1-20/70(DD474, 475, 479, 480, 501, 511, 513, 541, 545,546, 553, 558, 562, 565,567,568,570, 572-575, 583, 585, 587, 588, 590, 593-597, 631, 649,653,654,656, 658, 660, 662, 667, 680, 683, 684, 688, 690,691, 797,798), 1x5-533TT(DD448, 478, 519-521,527, 528, 530-532, 534-540,544,547, 554, 556,561, 563,564,566, 578, 580, 589, 592,629,630,642-644,650-652,655, 657,659, 661, 665, 666, 668-679, 681, 682, 685-687, 689,793-796,799, 800, 802, 804), 2x5-533TT(DD474, 475, 479, 480, 501, 511, 513, 519, 541, 545,546, 553, 558, 562, 565,567,568,570,572-575, 583, 585, 587, 588, 590, 593-597, 631, 649,653,654,656, 658,660, 662, 667, 680, 683, 684, 688, 690,691, 797,799), 6DCT, 2DCR; SC, SG, Mk12/22 radars, QGA sonar

	Valkenburgh	
DD657	Charles J. Badger	1943
DD658	Colahan	1943
DD659	Dashiell	1943
DD660	Bullard	1943
DD661	Kidd	1943
DD662	Bennion	1943
DD665	Bryant	1943
DD666	Black	1943
DD667	Chauncey	1943
DD668	Clarence K. Bronson	1943
DD669	Cotten	1943
DD670	Dortch	1943
DD671	Gatling	1943
DD672	Healy	1943
DD673	Hickox	1943
DD674	Hunt	1943
DD675	Lewis Hancock	1943
DD676	Marshall	1943
DD677	McDermut	1943
DD678	McGowan	1943
DD679	McNair	1944
DD680	Melvin	1943
DD681	Hopewell	1943
DD682	Porterfield	1943
DD683	Stockham	1944
DD684	Wedderburn	1944
DD685	Picking	1943
DD686	Halsey Powell	1943
DD687	Uhlmann	1943
DD688	Remey	1943
DD689	Wadleigh	1943
DD690	Norman Scott	1943
DD691	Mertz	1943
DD793	Cassin	1943
DD794	Irwin	1944
DD795	Preston	1944
DD796	Benham	1943

DD

DD797	Cushing	1944
DD798	Monssen	1944
DD799	Jarvis	1944
DD800	Porter	1944
DD802	Gregory	1944
DD804	Rooks	1944

DD692	Allen M. Sumner	1944
DD693	Moale	1944
DD694	Ingraham	1944
DD696	English	1944
DD697	Charles S. Sperry	1944
DD698	Ault	1944
DD699	Waldron	1944
DD700	Haynsworth	1944
DD701	John W. Weeks	1944
DD702	Hank	1944
DD703	Wallace L. Lind	1944
DD704	Borie	1944
DD705	Compton	1944
DD706	Gainard	1944
DD707	Soley	1944
DD708	Harlan R. Dickson	1945
DD709	Hugh Purvis	1945
DD722	Barton	1943
DD723	Walke	1944
DD724	Laffey	1944
DD725	O'Brien	1944
DD727	De Haven	1944
DD728	Mansfield	1944
DD729	Lyman K. Swenson	1944
DD730	Collett	1944
DD731	Maddox	1944
DD732	Hyman	1944
DD734	Purdy	1944
DD744	Blue	1944
DD745	Brush	1944

Allen M. Sumner

53

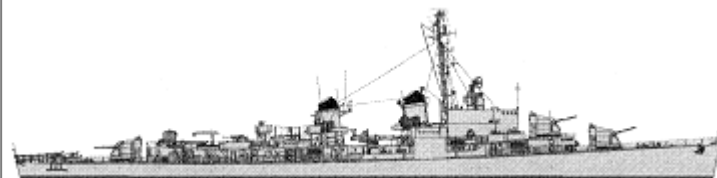

3218t, 114.8x12.5x4.3m, 4b,2gst, 60000hp, 36.5kts, 336p; 3x2-127/38, (3x4+2x2)-40/60, 10x2-20/70, 1x5-533TT, 6DCT, 2DCR; SG, SR, Mk12/22 radars, QGA sonar

DD746	Taussig	1944
DD747	Samuel N. Moore	1944
DD748	Harry E. Hubbard	1944
DD752	Alfred A. Cunningham	1944
DD753	John R. Pierce	1944
DD754	Frank E. Evans	1945
DD755	John A. Bole	1945
DD756	Beatty	1945
DD757	Putnam	1944
DD758	Strong	1945
DD759	Lofberg	1945
DD760	John W. Thomason	1945
DD761	Buck	1946
DD762	Henley	1946
DD770	Lowry	1944
DD775	Willard Keith	1944
DD776	James C. Owens	1945
DD777	Zellars	1944
DD778	Massey	1944
DD779	Douglas H. Fox	1944
DD780	Stormes	1945
DD781	Robert K. Huntington	1945
DD857	Bristol	1945
DD710	Gearing	1945
DD716	Wiltsie	1946
DD717	Theodore E. Chandler	1946
DD718	Hamner	1946
DD763	William C. Lawe	1946
DD782	Rowan	1945
DD783	Gurke	1945
DD784	McKean	1945
DD785	Henderson	1945
DD786	Richard B. Anderson	1945

Gearing 47

DD787	James E. Kyes	1946
DD788	Hollister	1946
DD789	Eversole	1946
DD790	Shelton	1946
DD808	Dennis J. Buckley	1945
DD821	Johnston	1946
DD822	Robert H. McCard	1946
DD823	Samuel B. Roberts	1946
DD826	Agerholm	1946
DD836	George K. Mackenzie	1945
DD837	Sarsfield	1945
DD839	Power	1945
DD840	Glennon	1945
DD841	Noa	1945
DD843	Warrington	1945
DD844	Perry	1946
DD845	Baussell	1946
DD846	Ozbourn	1946
DD848	Witek	1946
DD849	Richard E. Kraus	1946
DD850	Joseph P. Kennedy, Jr.	1945
DD851	Rupertus	1946
DD852	Leonard F. Mason	1946
DD853	Charles H. Roan	1946
DD862	Vogelgesang	1945
DD864	Harold J. Ellison	1945
DD865	Charles R. Ware	1945
DD866	Cone	1945
DD867	Stribling	1945
DD868	Brownson	1945
DD869	Arnold J. Isbell	1946
DD872	Forrest Royal	1946
DD884	Floyd B. Parks	1945

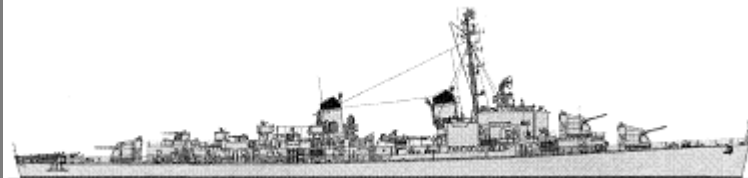

3460t, 119.0x12.5x4.4m, 4b,2gst, 60000hp, 36.8kts, 336p; 3x2-127/38(DD710,716-718,763,782-1790,808,821-823,826,836,839-841,843-846,849-853,862,864-869,872,874-877,890), 2x2-127/38(DD838,847), (3x4+2x2)-40/60, 11x1-20/70, 1x5-533TT, 6DCT, 2DCR; SPS-6, SPS-10, Mk12/22 radars, SQS-4 sonar

			DD885	John R. Craig	1945		
			DD886	Orleck	1945		
			DD887	Brinkley Bass	1945		
			DD890	Meredith	1945		
	Mitscher	4	DL2	Mitscher	1953		4855t, 149.4x14.5x4.5m, 4b,2gst, 80000hp, 36.5kts, 350p; 2x1-127/54, 2x2-76/70, 4x2-20/70, 4-533TT, 1x1-324WeaponAlfa; SPS-6, SPS-8 radars, SQS-4 sonar
			DL3	John S. McCain	1953		
			DL4	Willis A. Lee	1954		
			DL5	Wilkinson	1954		
	Forrest Sherman	18	DD931	Forrest Sherman	1955		4916t, 127.6x13.7x4.6m, 4b,2gst, 70000hp, 33kts, 324p; 3x1-127/54, 2x2-76/50, 4-533TT (DD931,932), 2x3-324TT, 2x24-178Hedgehog, 1DCR; SPS-6, SPS-10, SPG-53A radars, SQS-4 sonar
			DD932	John Paul Jones	1956		
			DD933	Barry	1956		
			DD936	Decatur	1956		
			DD937	Davis	1957		
			DD938	Jonas Ingram	1957		
			DD940	Manley	1957		
			DD941	Du Pont	1957		
			DD942	Bigelow	1957		
			DD943	Blandy	1957		
			DD944	Mullinix	1958		
			DD945	Hull	1958		
			DD946	Edson	1959		
			DD947	Somers	1959		
			DD948	Morton	1959		
			DD949	Parsons	1959		
			DD950	Richard S. Edwards	1959		
			DD951	Turner Joy	1959		
	Fletcher	18	DDE445	Fletcher	1942		2950t, 114.8x12.1x5.5m, 4b,2gst, 60000hp, 35kts; 2x1-127/38, 2x2-76/50, 4x2-20/70, 4-533TT, 1x1-324Weapon Alfa, 2x24-178Hedgehog; SPS-6 radar, QHB sonar
			DDE446	Radford	1942		
			DDE447	Jenkins	1942		
			DDE449	Nicholas	1942		
			DDE450	O'Bannon	1942		
			DDE465	Saufley	1942		
			DDE466	Waller	1942		
			DDE468	Taylor	1942		
			DDE470	Bache	1942		
			DDE471	Beale	1942		

DDE

DDE498	Philip	1942
DDE499	Renshaw	1942
DDE507	Conway	1942
DDE508	Cony	1942
DDE510	Eaton	1942
DDE517	Walker	1943
DDE576	Murray	1943
DDE577	Sproston	1943

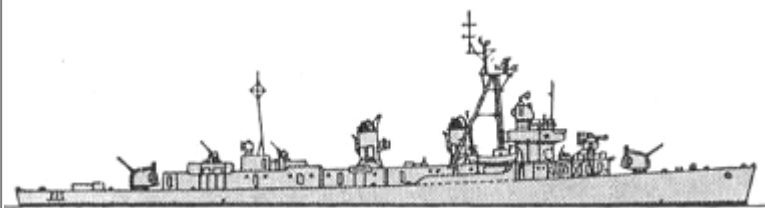

Gearing

15

DDE719	Epperson	1949
DDE764	Lloyd Thomas	1947
DDE765	Keppler	1947
DDE818	New	1946
DDE819	Holder	1946
DDE820	Rich	1946
DDE824	Basilone	1949
DDE825	Carpenter	1949
DDE827	Robert A. Owens	1949
DDE847	Robert L. Wilson	1946
DDE858	Fred T. Berry	1945
DDE859	Norris	1945
DDE860	McCaffery	1945
DDE861	Harwood	1945
DDE871	Damato	1946

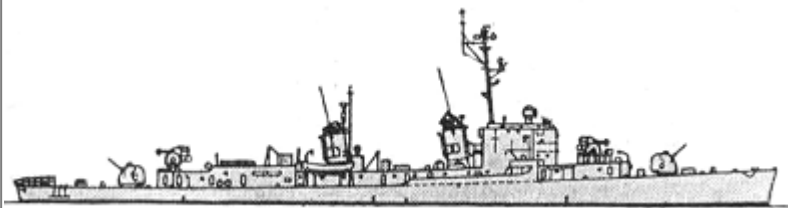

3460t, 119.0x12.5x4.4m, 4b,2gst, 60000hp, 36.8kts, 336p; 2x2-127/38, 4x2-20/70, 1x5-533TT, 1x24-178Hedgehog, 6DCT, 2DCR; SPS-6, SPS-10 radars, SQS-4 sonar

DDR711	Eugene A. Greene	1945
DDR713	Kenneth D. Bailey	1945
DDR714	William R. Rush	1945
DDR715	William M. Wood	1945
DDR742	Frank Knox	1944
DDR743	Southerland	1944
DDR805	Chevalier	1945
DDR806	Higbee	1945
DDR807	Benner	1945
DDR817	Corry	1946

DDR	Gearing	34	DDR829	Myles C. Fox	1945
			DDR830	Everett F. Larson	1945
			DDR831	Goodrich	1945
			DDR832	Hanson	1945
			DDR833	Herbert J. Thomas	1945
			DDR834	Turner	1945
			DDR835	Charles P. Cecil	1945
			DDR838	Ernest G. Small	1945
			DDR842	Fiske	1945
			DDR863	Steinaker	1945
			DDR870	Fechteler	1946
			DDR873	Hawkins	1945
			DDR874	Duncan	1945
			DDR875	Henry W. Tucker	1945
			DDR876	Rogers	1945
			DDR877	Perkins	1945
			DDR878	Vesole	1945
			DDR879	Leary	1945
			DDR880	Dyess	1945
			DDR881	Bordelon	1945
DDR882	Furse	1945			
DDR883	Newman K. Perry	1945			
DDR888	Stickell	1945			
DDR889	O'Hare	1945			
			DE51	Buckley	1943
			DE57	Fogg	1943
			DE59	Foss	1943
			DE153	Reuben James	1943
			DE198	Lovelace	1943
			DE199	Manning	1943
			DE200	Neundorf	1943
			DE201	James E. Craig	1943
			DE202	Eichenberger	1943
			DE203	Thomason	1943
DE210	Otter	1944			



3460t, 119.0x12.5x4.4m, 4b,2gst, 60000hp, 36.8kts, 336p; 3x2-127/38, (3x4+2x2)-40/60, 11x1-20/70, 1x5-533TT, 6DCT, 2DCR; SPS-6, SPS-8, SPS-10, Mk12/22 radars, SQS-4 sonar

Buckley 53

DE213	William T. Powell	1944
DE214	Scott	1943
DE217	Coolbaugh	1943
DE218	Darby	1943
DE219	J. Douglas Blackwood	1943
DE220	Francis M. Robinson	1944
DE222	Fowler	1944
DE223	Spangenberg	1944
DE575	Ahrens	1944
DE577	Alexander J. Luke	1944
DE578	Robert I. Paine	1944
DE633	Foreman	1943
DE634	Whitehurst	1943
DE638	Willmarth	1944
DE639	Gendreau	1944
DE640	Fieberling	1944
DE641	William C. Cole	1944
DE642	Paul G. Baker	1944
DE643	Damon M. Cummings	1944
DE665	Jenks	1944
DE666	Durik	1944
DE667	Wiseman	1944
DE678	Harmon	1943
DE679	Greenwood	1943
DE680	Loeser	1943
DE681	Gillette	1943
DE683	Henry R. Kenyon	1943
DE696	Spangler	1943
DE697	George	1943
DE699	Marsh	1944
DE700	Currier	1944
DE701	Osmus	1944
DE702	Earl V. Johnson	1944
DE703	Holton	1944
DE790	Borum	1943



1823t, 93.3x11.3x3.4m, 2b,2stg,2em, 12000hp, 23kts, 186p; 2x1-127/38(DE51,57,153,213,217-219,223,577,578, 678-680,696-698,700,701), 3x1-76/50(DE59,198-203,210,214,220-222,575,633,634, 638-644,665-667,681,683,695,699,702-705,790,791,795-800), 1x2-40/60(DE59,198-203,210,214,220-222,633,634,638-644,665-667,681,683,695,699,702-705,790,791,795-800), (1x4+3x2)-40/60(DE51,57,153,213,217-219,223,678-680, 696-698,700,701), 3x2-40/60(DE575,577,578), 8x1-20/70(DE59,198-203,210,214,220-222,633,634,638-644,665-667,681,683,695,699,702-705,790,791,795-800), 1x3-533TT(DE59,198-203,210,214,220-222,633,634,638-644,665-667,681,683,695,699,702-705,790,791,795-800), 1x24-178Hedgehog, 8DCT, 2DCR; SA, SU radars, sonar

		EDE791	Maloy	1943
		DE795	Gunason	1944
		DE796	Major	1944
		DE797	Weeden	1944
		DE798	Varian	1944
		DE799	Scroggins	1944
		DE800	Jack W. Wilke	1944
Cannon	22	DE162	Levy	1943
		DE163	McConnell	1943
		DE164	Osterhaus	1943
		DE165	Parks	1943
		DE167	Acree	1943
		DE170	Booth	1943
		DE171	Carroll	1943
		DE172	Cooner	1943
		DE176	Micka	1943
		DE180	Trumpeter	1943
		DE181	Straub	1943
		DE191	Coffman	1943
		DE742	Hilbert	1944
		DE743	Lamons	1944
		DE744	Kyne	1944
		DE745	Snyder	1944
		DE748	Tills	1944
		DE749	Roberts	1944
		DE750	McClelland	1944
		DE765	Earl K. Olsen	1944
		DE767	Oswald	1944
		DE769	Neal A. Scott	1944
		DE129	Edsall	1943
		DE130	Jacob Jones	1943
		DE131	Hammann	1943
		DE132	Robert E. Peary	1943
		DE134	Pope	1943
		DE135	Flaherty	1943
		DE137	Herbert C. Jones	1943
		DE138	Douglas L. Howard	1943
		DE139	Farquhar	1943

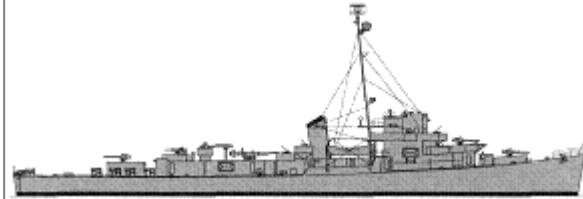

1602t, 93.3x11.2x3.2m, 4dg,2em, 6000hp, 21kts, 186p; 3x1-76/50, 1x2-40/60, 8x1-20/70(DE15,113,162-173,176,180-196,739,763,764), 10x1-20/70(DE740-750,765-769), 1x3-533TT, 1x24-178Hedgehog, 8DCT,2DCR, SA, SU radars, sonar

Edsall

65

DE140	J. R. Y. Blakely	1943
DE141	Hill	1943
DE144	Frost	1943
DE145	Huse	1943
DE146	Inch	1943
DE148	Brough	1943
DE149	Chatelaine	1943
DE150	Neunzer	1943
DE151	Poole	1943
DE152	Peterson	1943
DE238	Stewart	1943
DE240	Moore	1943
DE241	Keith	1943
DE242	Tomich	1943
DE243	J. Richard Ward	1943
DE245	Sloat	1943
DE246	Snowden	1943
DE247	Stanton	1943
DE248	Swasey	1943
DE249	Marchand	1943
DE250	Hurst	1943
DE252	Howard D. Crow	1943
DE253	Pettit	1943
DE254	Picketts	1943
DE255	Sellstrom	1943
DE316	Harveston	1943
DE320	Menges	1943
DE321	Mosley	1943
DE323	Pride	1943
DE330	O'Reilly	1943
DE335	Daniel	1944
DE337	Dale W. Peterson	1944
DE338	Martin H. Ray	1944
DE385	Richey	1943
DE392	Merrill	1943
DE394	Swenning	1943
DE395	Willis	1943
DE396	Jahnssen	1943

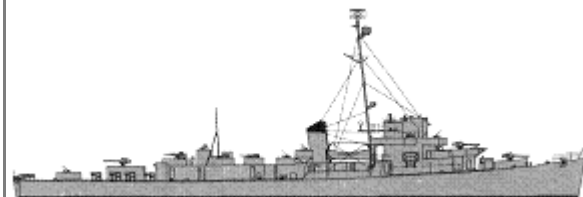

1602t, 93.3x11.2x3.2m, 4d(2), 6000hp, 21kts, 186p; 3x1-76/50, 1x2-40/60, 8x1-20/70, 1x3-533TT, 1x24-178Hedgehog, 8DCT, 2DCR; SA, SU radars, sonar

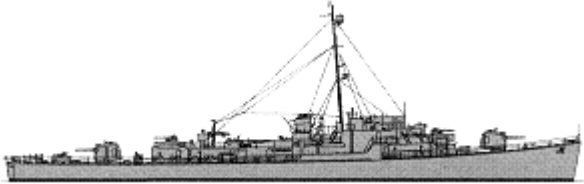
FF		DE398	Cockrill	1943		
		DE399	Stockdale	1943		
	Rudderow 20	DE224	Rudderow	1944		<p>1811t, 93.3x11.3x3.4m, 2b,2stg,2em, 12000hp, 23kts, 156p; 2x1-127/38, 2x2-40/60, 10x1-20/70(DE224,225,231,579-589,706-708), 8x1-20/70(DE684-686), 1x3-533TT, 1x24-178Hedgehog, 8DCT, 2DCR</p>
		DE225	Day	1944		
		DE231	Hodges	1944		
		DE579	Riley	1944		
		DE580	Leslie L. B. Knox	1944		
		DE581	McNulty	1944		
		DE582	Metivier	1944		
		DE583	George A. Johnson	1944		
		DE584	Charles J. Kimmel	1944		
		DE585	Daniel A. Joy	1944		
		DE586	Lough	1944		
		DE587	Thomas F. Nickel	1944		
		DE588	Peiffer	1944		
		DE589	Tinsman	1944		
		DE684	DeLong	1943		
		DE685	Coates	1944		
		DE686	Eugene E. Elmore	1944		
		DE706	Holt	1944		
		DE707	Jobb	1944		
		DE708	Parle	1944		
		DE339	John C. Butler	1944		
		DE340	O'Flaherty	1944		
		DE341	Raymond	1944		
		DE342	Richard W. Suesens	1944		
		DE343	Abercrombie	1944		
		DE344	Oberrender	1944		
		DE345	Robert Brazier	1944		
		DE346	Edwin A. Howard	1944		
		DE347	Jesse Rutherford	1944		
		DE348	Key	1944		
		DE349	Gentry	1944		
		DE350	Traw	1944		
			Maurice J.			

DE351	Manuel	1944
DE352	Naifeh	1944
DE353	Doyle C. Barnes	1944
DE354	Kenneth M. Willett	1944
DE355	Jaccard	1944
DE356	Lloyd E. Acree	1944
DE357	George E. Davis	1944
DE358	Mack	1944
DE359	Woodson	1944
DE360	Johnie Hutchins	1944
DE361	Walton	1944
DE362	Rolf	1944
DE363	Pratt	1944
DE364	Rombach	1944
DE365	McGinty	1944
DE366	Alvin C. Cockrell	1944
DE367	French	1944
DE368	Cecil J. Doyle	1944
DE369	Thaddeus Parker	1944
DE370	John L. Williamson	1944
DE371	Presley	1944
DE372	Williams	1944
DE402	Richard S. Bull	1944
DE403	Richard M. Rowell	1944
DE405	Dennis	1944
DE406	Edmonds	1944
DE408	Straus	1944
DE409	La Prade	1944
DE410	Jack Miller	1944
DE411	Stafford	1944
DE412	Walter C. Wann	1944
DE414	Le Ray Wilson	1944
DE415	Lawrence C. Taylor	1944



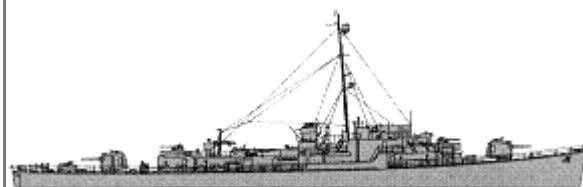

John C.
Butler

64



1811t, 93.3x11.3x3.4m, 2b,2stg,2em, 12000hp, 23kts, 156p; 2x1-127/38, 2x2-40/60(DE339-343,345-372,402,403,405,406, 408-412,414-424,438-450,508-510,531-536), (1x4+3x2)-40/60(DE537,538), 10x1-20/70(DE339-343,345-372,402,403,405,406, 408-412,414-424,438-447,508, 509,531-538), (3x2+10x1)-20/70(DE448-450,510), 1x3-533TT(DE339-343,345-372,402,403,405, 406,408-412,414-424,438-447,508, 509,531-536), 1x24-178Hedgehog, 8DCT, 2DCR; SA, SU radars, sonar



DE416	Melvin R. Nawman	1944
DE417	Oliver Mitchell	1944
DE418	Tabberer	1944
DE419	Robert F. Keller	1944
DE420	Leland E. Thomas	1944
DE421	Chester T. O'Brien	1944
DE422	Douglas A. Munro	1944
DE423	Dufilho	1944
DE424	Haas	1944
DE438	Corbesier	1944
DE439	Conklin	1944
DE441	William Seiverling	1944
DE442	Ulvert M. Moore	1944
DE443	Kendall C. Campbell	1944
DE444	Goss	1944
DE445	Grady	1944
DE446	Charles E. Brannon	1944
DE447	Albert T. Harris	1944
DE448	Cross	1945
DE449	Hanna	1945
DE450	Joseph E. Connolly	1945
DE508	Gilligan	1944
DE510	Heyliger	1945
DE531	Edward H. Allen	1943
DE533	Howard F. Clark	1944
DE534	Silverstein	1944
DE536	Bivin	1944
DE537	Rizzi	1945
DE538	Osberg	1945
DE1006	Dealey	1954
DE1014	Cromwell	1954

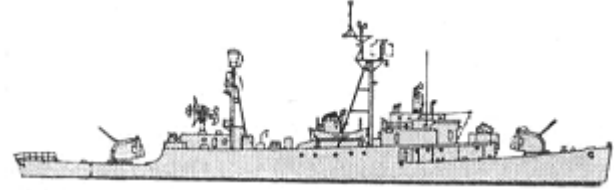

Dealey	13	DE1015	Hammerberg	1955		1877t, 96.0x11.2x3.6m, 2b,1gst, 2000hp, 27kts, 173p; 2x2-76/50, 2x3-305Squid(DE1006), 1x1-324WeaponAlfa(DE1014,1015,1021-1030); SPS-5, SPS-6C radars, SQS-4 sonar				
		DE1021	Courtney	1956						
		DE1022	Lester	1957						
		DE1023	Evans	1957						
		DE1024	Bridget	1957						
		DE1025	Bauer	1957						
		DE1026	Hooper	1958						
		DE1027	John Willis	1957						
		DE1028	Van Voorhis	1957						
		DE1029	Hartley	1957						
		DE1030	Joseph K. Taussig	1957						
		Claud Jones	3	DE1033			Claud Jones	1959		1916t, 95.1x11.6x3.9m, 4d(1), 8700hp, 21.5kts, 171p; 2x1-76/50, 2x3-324TTT, 2x24-178Hedgehog, 1 dcr; SPS-6C, SPS-10 radars, SQS-4 sonar
				DE1034			John R. Perry	1959		
DE1035	Charles Berry			1959						
Buckley DEC	4	DE644	Vammen	1944		1823t, 93.3x11.3x3.4m, 2b,2stg,2em, 12000hp, 23kts, 186p; 2x1-127/38, (1x4+3x2)-40/60, 6x1-20/70, 2x24-278Hedgehog, 8DCT, 2DCR; SA, SU, SPS-6 radars, sonar				
		DE698	Raby	1943						
		DE704	Cronin	1944						
		DE705	Frybarger	1944						
John C. Butler	2	DEC532	Tweedy	1944		1811t, 93.3x11.3x3.4m, 2b,2stg,2em, 12000hp, 23kts, 156p; 2x1-127/38, (1x4+3x2)-40/60, 10x1-20/70, 2x24-178Hedgehog, 8DCT, 2DCR; SA, SU radars, sonar				
		DEC535	Lewis	1944						
		DER133	Pillsbury	1943						
		DER142	Fessenden	1943						
		DER147	Blair	1943						
		DER239	Sturtevant	1943						
		DER244	Otterstetter	1943						
		DER251	Camp	1943						
		DER317	Joyce	1943						
		DER318	Kirkpatrick	1943						
		DER322	Newell	1943						
		DER324	Falgout	1943						
		DER325	Lowe	1943						
		DER326	Thomas J. Gary	1943						
		DER327	Brister	1943						
		DER328	Finch	1943						

FFR	Edsall	30	DER329	Kretchmer	1943		1602t, 93.3x11.2x3.2m, 4d(2), 6000hp, 21kts, 186p; 2x1-127/38, (1x4+3x2)-40/60, 6x1-20/70, 1x3-533TT, 1x24-178Hedgehog, 8DCT, 2DCR; SPS-10, SPS-29 radars, sonar					
			DER331	Koiner	1943							
			DER332	Price	1944							
			DER333	Strickland	1944							
			DER334	Forster	1944							
			DER336	Roy O. Hale	1944							
			DER382	Ramsden	1943							
			DER383	Mills	1943							
			DER384	Rhodes	1943							
			DER386	Savage	1943							
			DER387	Vance	1943							
			DER388	Lansing	1943							
			DER389	Durant	1943							
			DER390	Calcaterra	1943							
			DER391	Chambers	1943							
			DER393	Haverfield	1943							
			DER397	Wilhoite	1943							
			DER400	Hissem	1944							
				John C. Butler	2			DER539	Wagner	1955		1811t, 93.3x11.3x3.4m, 2b,2stg,2em, 12000hp, 23kts, 156p; 2x1-127/38, (1x4+3x2)-40/60, 6x1-20/70, 1x24-178Hedgehog, 8DCT, 2DCR; SPS-10, SPS-29, Mk25 radars, sonar
								DER540	Vandivier	1955		

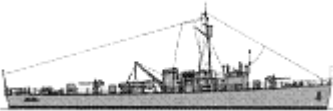

PATROL AND COASTAL COMBATANTS

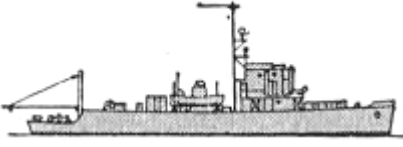
			PC465	Paragould	1942		
			PC466	Carmi	1942		
			PC470	Antigo	1942		
			PC483	Rolla	1942		
			PC484	Cooperstown	1942		
			PC487	Larchmont	1942		
			PC564	Chadron	1942		
			PC565	Gilmer	1942		
			PC566	Honesdale	1942		
			PC567	Riverhead	1942		
			PC568	Altus	1942		
			PC569	Petoskey	1942		
			PC572	Tooele	1942		
			PC579	Wapakoneta	1942		

PC	PC461	37	PC580	Malvern	1942		463t, 52.9x7.1x3.3m, 2d, 2880hp, 19kts, 65p; 1x1-76/50, 1x1-40/60, 4x1-20/70, 2x4-178Mousetrap, 2DCT, 2DCR; SU radar, sonar
			PC581	Manville	1942		
			PC582	Lenoir	1942		
			PC601	Arcata	1942		
			PC602	Alturas	1942		
			PC603	Solvay	1942		
			EPC618	Weatherford	1942		
			PC619	Dalhart	1942		
			PC776	Pikeville	1943		
			PC1079	Ludington	1943		
			PC1136	Galena	1943		
			PC1140	Glenwood	1944		
			PC1145	Winnemucca	1944		
			PC1170	Kelso	1944		
			PC1172	Olney	1943		
			PC1173	Andalusia	1943		
			PC1176	Minden	1943		
			PC1179	Morris	1944		
			PC1180	Woodstock	1944		
			PC1230	Grinnell	1943		
PC1252	Tarrytown	1943					
PC1546	Grosse Pointe	1944					
PC1569	Anacortes	1945					
PC(C)461	3	PC(C)1177	Guymon	1943		463t, 52.9x7.1x3.3m, 2d, 2880hp, 19kts, 65p; 1x1-76/50, 2x4-178Mousetrap, 2DCT, 2DCR; SU radar, sonar	
		PC(C)1244	Martinez	1943			
		PC(C)1251	Ukiah	1943			
PCE842	14	PCE842	Marfa	1944		903t, 56.2x10.1x2.9m, 2d, 2000hp, 15.1kts, 96p; 1x1-76/50, 2x2-40/60, 5x1-20/70, 1x24-178Hedgehog, 4DCT, 2DCR; SU radar, sonar	
		PCE843	Skowhegan	1944			
		PCE845	Worland	1944			
		PCE846	Eunice	1944			
		PCE870	Dania	1943			
		PCE880	Ely	1944			
		PCE892	Somerset	1944			
		PCE894	Farmington	1944			
		PCE895	Crestview	1944			
		PCE899	Lamar	1945			
		PCE900	Groton	1945			
		PCE902	Portage	1945			
		PCE903	Batesburg	1945			
		PCE904	Gettysburg	1945			
		PCE(R)849	Somersworth	1944			

PCE(R)	8	PCE(R)850	Fairview	1944		903t, 56.2x10.1x2.9m, 2d, 2000hp, 15.1kts, 96p; 1x1-76/50, 1x2-40/60, 4x1-20/70, 1x24-178Hedgehog, 4DCT, 2DCR; SU radar, sonar	
		EPCE(R)851	Rockville	1944			
		PCE(R)852	Brattleboro	1944			
		PCE(R)853	Amherst	1944			
		EPCE(R)855	Rexburg	1944			
		PCE(R)856	Whitehall	1944			
		EPCE(R)857	Marysville	1945			
PCE(C)	2	PCE877	Harve	1944		903t, 56.2x10.1x2.9m, 2d, 2000hp, 15.1kts, 96p; 1x1-76/50, 1x2-40/60, 4x1-20/70, 1x24-178Hedgehog, 4DCT, 2DCR; SU radar, sonar	
		PCE886	Banning	1945			
PCS	5	PCS1385	Hollidaysburg	1944		278t, 41.5x7.5x2.4m, 2d, 800hp, 14kts, 57p; 1x1-76/50, 1x1-40/60, 2x1-20/70, 2x4-178Mousetrap, 4DCT, 2DCR; SU radar, sonar	
		PCS1387	Beaufort	1944			
		PCS1401	McMinnville	1945			
		PCS1423	Prescott	1943			
		EPCS1431	Grafton	1944			
YP	YP654	10	YP654-663		1958	No picture	66t, 24.7x5.5x1.8m, 4d(2), 437hp, 12kts, 10p; radar

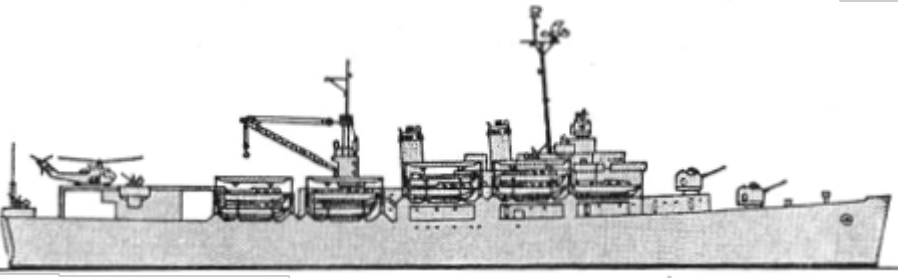
MINE WARFARE AND MINE COUNTERMEASURES

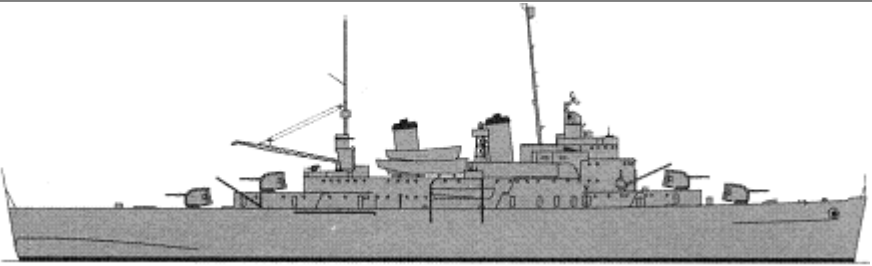
MCS	Catskill	5	MCS1	Catskill	1944		9040t, 138.8(MCS1,2)-139.6(MCS3-5)x18.4x6.1m, 4b,2gst, 11000hp, 20.3kts, 564p; 4x1-127/38(MCS1,2), (1x2+2x1)-127/38(MCS3-5), 4x2-40/60, 20x1-20/70(MCS1,2), 6x2-20/70(MCS3-5); SU radar
			MCS2	Ozark	1944		
			MCS3	Osage	1944		
			MCS4	Saugus	1945		
			MCS5	Monitor	1944		
LST	1	MCS6	Orleans Parish	1945		4080t, 100.0x15.2x4.3m, 2d, 1800hp, 12.1kts, 125p; (2x2+4x1)-40/60, 12x1-20/70; SU radar	
CM	Terror	1	CM5	Terror	1942		8640t, 138.6x18.3x6.0m, 4b,2gst, 11000hp, 18kts, 481p; 4x1-127/38, 4x4-40/60, 14x1-20/70, 900mines; SC, SG, Mk4 radars
			DM23	Robert H. Smith	1944		
			DM24	Thomas E. Fraser	1944		

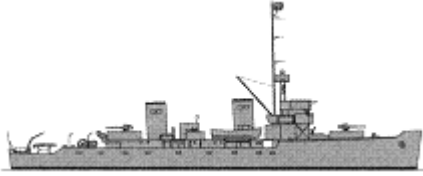
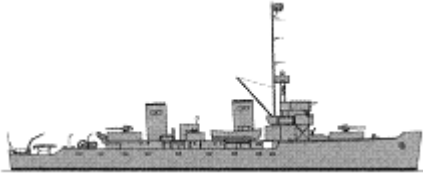
DM	Robert H. Smith	10	DM25	Shannon	1944		3218t, 114.8x12.5x4.3m, 4b,2gst, 60000hp, 36.5kts, 336p; 3x2-127/38, (2x4+2x2)-40/60, 8x1-20/70, 4DCT, 2DCR, 120mines; SG, SR, Mk12/22 radars, QGA sonar
			DM26	Harry F. Bauer	1944		
			DM27	Adams	1944		
			DM28	Tolman	1944		
			DM29	Henry A. Wiley	1944		
			DM30	Shea	1944		
			DM32	Lindsey	1944		
			DM33	Gwin	1944		
MMC	Auk	2	MMC3	Triumph	1944		1250t, 67.4x9.8x3.3m, 2d, 2880hp, 18kts, 105p; 1x1-76/50, 2x1-40/60, 8x1-20/70, 1x24-178Hedgehog, 4DCT, 2DCR, 80mines
			MMC5	Seer	1942		
	Raven	1	MSF55	Raven	1940		1040t, 67.1x9.8x2.8m, 2d, 2880hp, 18kts, 105p; 1x1-76/50, 2x1-40/60, 8x1-20/70, 1x24-178Hedgehog, 4DCT, 2DCR, 80mines, sweeps
			MSF58	Broadbill	1942		
			MSF59	Chickadee	1942		
			MSF60	Nuthatch	1942		
			MSF61	Pheasant	1942		
			MSF64	Starling	1942		
			MSF100	Heed	1943		
			MSF101	Herald	1943		
			MSF102	Motive	1943		
			MSF103	Oracle	1943		
			MSF104	Pilot	1943		
			MSF105	Pioneer	1943		
			MSF110	Revenge	1943		
			MSF111	Sage	1943		
			MSF114	Staff	1942		
			MSF116	Speed	1942		
			MSF118	Steady	1942		
			MSF120	Sway	1943		
			MSF122	Swift	1943		
			MSF123	Symbol	1942		
MSF124	Threat	1943					
MSF126	Token	1942					
MSF127	Tumult	1943					
MSF128	Velocity	1943					

Auk

53

MSF131	Zeal	1943
MSF314	Champion	1943
MSF315	Chief	1943
MSF316	Competent	1943
MSF317	Defense	1944
MSF318	Devastator	1944
MSF319	Gladiator	1944
MSF320	Impeccable	1944
MSF322	Spear	1943
MSF324	Vigilance	1944
MSF340	Ardent	1944
MSF341	Dextrous	1943
MSF372	Murrelet	1945
EMSF373	Peregrine	1945
MSF374	Pigeon	1945
MSF375	Pochard	1944
MSF376	Ptarmigan	1945
MSF377	Quail	1945
MSF378	Redstart	1945
MSF379	Roselle	1945
MSF380	Ruddy	1945
MSF381	Scoter	1945
MSF382	Shoveller	1945
MSF384	Sprig	1945
MSF385	Tanager	1945
MSF386	Tercel	1945
MSF387	Toucan	1944
MSF388	Towhee	1945
MSF389	Waxwing	1945
MSF390	Wheatear	1945
MSF159	Change	1944
MSF165	Counsel	1944
MSF214	Crag	1944
MSF215	Cruise	1944
MSF220	Device	1944
MSF221	Diploma	1944
MSF223	Dour	1944
MSF224	Eager	
MSF232	Execute	1944
MSF233	Facility	1944

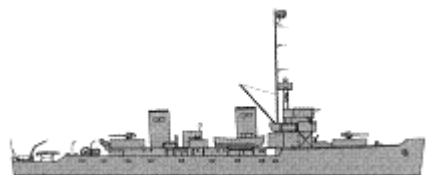

1250t, 67.4x9.8x3.3m, 2d, 2880hp, 18kts, 105p; 1x1-76/50, 2x1-40/60, 8x1-20/70, 1x24-178Hedgehog, 4DCT, 2DCR, 80mines, sweeps

MSO	Admirable 46	MSF238	Garland	1944
		MSF239	Gayety	1944
		MSF240	Hazard	1944
		MSF241	Hilarity	1944
		MSF242	Inaugural	1944
		MSF252	Instill	1944
		MSF253	Intrigue	1944
		MSF254	Invade	1944
		MSF255	Jubilant	1943
		MSF256	Knave	1943
		MSF269	Opponent	1944
		MSF280	Prowess	1944
		MSF283	Ransom	1944
		MSF284	Rebel	1944
		MSF285	Recruit	1944
		MSF289	Report	1946
		MSF296	Scout	1944
		MSF297	Scrimmage	1944
		MSF298	Scuffle	1944
		MSF299	Sentry	1944
		MSF300	Serene	1944
		MSF301	Shelter	1944
		MSF302	Signet	1944
		MSF303	Skirmish	1944
		MSF304	Scurry	1944
		MSF306	Specter	1944
		MSF307	Staunch	1944
		MSF308	Strategy	1944
		MSF309	Strength	1944
		MSF310	Success	1944
		MSF311	Superior	1944
		MSF356	Creddock	1945
		MSF357	Dipper	1945
		MSF362	Gadwall	1945
		MSF364	Graylag	1945
MSF365	Harlequin	1945		
		MSO421	Agile	1956
		MSO422	Aggressive	1953
		MSO423	Avenge	1954
		MSO424	Bold	1953
		MSO425	Bulwark	1953

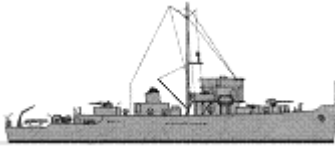

945t, 56.2x10.1x3.0m, 2d, 2000hp, 15.1kts, 96p; 1x1-76/50, 2x1-40/60, 4x1-20/70, sweeps; SU radar, sonar



Agile





61

MSO426	Conflict	1954
MSO427	Constant	1954
MSO428	Dash	1953
MSO429	Detector	1953
MSO430	Direct	1954
MSO431	Dominant	1954
MSO432	Dynamic	1953
MSO433	Engage	1954
MSO434	Embattle	1954
MSO435	Endurance	1954
MSO436	Energy	1954
MSO437	Enhance	1955
MSO438	Esteem	1955
MSO439	Excel	1955
MSO440	Exploit	1954
MSO441	Exultant	1954
MSO442	Fearless	1954
MSO443	Fidelity	1955
MSO444	Firm	1954
MSO445	Force	1955
MSO446	Fortify	1954
MSO447	Guide	1955
MSO448	Illusive	1953
MSO449	Impervious	1954
MSO455	Implicit	1954
MSO456	Inflict	1954
MSO457	Loyalty	1954
MSO458	Lucid	1955
MSO459	Nimble	1955
MSO460	Notable	1955
MSO461	Observer	1955
MSO462	Pinnacle	1955
MSO463	Pivot	1954
MSO464	Pluck	1954
MSO466	Prime	1954
MSO467	Reaper	1954
MSO468	Rival	1954
MSO469	Sagacity	1955
MSO470	Salute	1955
MSO471	Skill	1955

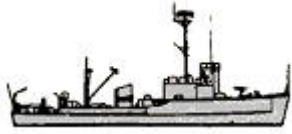

735t, 52.3x10.4x4.0m, 4d(2)(MSO421-427,432-449,455-474,488-496,508-511)-2d(MSO428-431), 3040(MSO421)-2280(MSO422-427,432-449,455-474,488-496,508-511)-1520(MSO428-431)hp, 14(MSO421-427,432-449,455-474,488-496,508-511)-13(MSO428-431)kts, 70p; 1x1-40/60, 2x1-2.7/90, sweeps; SPS-53 radar, UQS-1 sonar

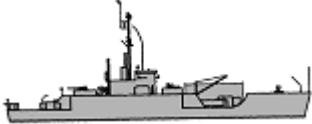
			MSO472	Valor	1954		
			MSO473	Vigor	1954		
			MSO474	Vital	1955		
			MSO488	Conquest	1955		
			MSO489	Gallant	1955		
			MSO490	Leader	1955		
			MSO491	Persistent	1956		
			MSO492	Pledge	1956		
			MSO493	Stalwart	1957		
			MSO494	Sturdy	1957		
			MSO495	Swerve	1957		
			MSO496	Venture	1958		
			MSO508	Acme	1957		
			MSO509	Adroit	1957		
			MSO510	Advance	1958		
			MSO511	Affray	1958		
	Ability	3	MSO519	Ability	1958		934t, 57.9x10.7x3.0m, 2d, 2700hp, 14.5kts, 83p; 1x1-40/60, 2x1-12.7/90, sweeps; SPS-53 radar, UQS-1 sonar
			MSO520	Alacrity	1958		
			MSO521	Assurance	1958		
	YMS	13	MSC(O)9	Flicker	1943		278t, 41.5x7.5x2.4m, 2d, 800hp, 14kts, 57p; 1x1-76/50, 1x1-40/60, 2x1-20/70, 2x4-178Mousetrap, 4DCT, 2DCR; SU radar, sonar
			MSC(O)13	Grackle	1943		
			MSC(O)15	Grouse	1943		
			MSC(O)21	Jackdaw	1944		
			MSC(O)24	Linnet	1943		
			MSC(O)33	Plover	1944		
			MSC(O)47	Fulmar	1943		
			MSC(O)49	Lorikeet	1943		
			MSC(O)51	Reedbird	1943		
			MSC(O)53	Robin	1943		
			MSC(O)54	Ruff	1943		
			MSC(O)56	Turkey	1944		
			MSC(O)58	Siskin	1944		
	MSC		MSC121	Bluebird	1953		
			MSC122	Cormorant	1953		
			MSC190	Falcon	1954		
			MSC191	Frigate Bird	1955		
			MSC192	Hummingbird	1955		
			MSC193	Jacana	1955		
			MSC194	Kingbird	1955		

	Bluebird	20	<table border="1"> <tr><td>MSC195</td><td>Limpkin</td><td>1955</td></tr> <tr><td>MSC196</td><td>Meadowlark</td><td>1955</td></tr> <tr><td>MSC197</td><td>Parrot</td><td>1955</td></tr> <tr><td>MSC198</td><td>Peacock</td><td>1955</td></tr> <tr><td>MSC199</td><td>Phoebe</td><td>1955</td></tr> <tr><td>MSC201</td><td>Shrike</td><td>1955</td></tr> <tr><td>MSC203</td><td>Thrasher</td><td>1955</td></tr> <tr><td>MSC204</td><td>Thrush</td><td>1955</td></tr> <tr><td>MSC205</td><td>Vireo</td><td>1955</td></tr> <tr><td>MSC206</td><td>Warbler</td><td>1955</td></tr> <tr><td>MSC207</td><td>Whippoorwill</td><td>1955</td></tr> <tr><td>MSC208</td><td>Widgeon</td><td>1955</td></tr> <tr><td>MSC209</td><td>Woodpecker</td><td>1956</td></tr> </table>	MSC195	Limpkin	1955	MSC196	Meadowlark	1955	MSC197	Parrot	1955	MSC198	Peacock	1955	MSC199	Phoebe	1955	MSC201	Shrike	1955	MSC203	Thrasher	1955	MSC204	Thrush	1955	MSC205	Vireo	1955	MSC206	Warbler	1955	MSC207	Whippoorwill	1955	MSC208	Widgeon	1955	MSC209	Woodpecker	1956		400t, 44.3x8.1x2.1m, 2d, 1200(MSC121,122,190-199)-880(MSC200-209)-1000(MSC289,290)hp, 13(MSC121,122,190-199)-12(MSC200-209)-12.5(MSC289,290)hp, 39p; 1x2-20/70, sweeps; SPS-53 radar, UQS-1 sonar																								
MSC195	Limpkin	1955																																																																		
MSC196	Meadowlark	1955																																																																		
MSC197	Parrot	1955																																																																		
MSC198	Peacock	1955																																																																		
MSC199	Phoebe	1955																																																																		
MSC201	Shrike	1955																																																																		
MSC203	Thrasher	1955																																																																		
MSC204	Thrush	1955																																																																		
MSC205	Vireo	1955																																																																		
MSC206	Warbler	1955																																																																		
MSC207	Whippoorwill	1955																																																																		
MSC208	Widgeon	1955																																																																		
MSC209	Woodpecker	1956																																																																		
MSI	Cove	2	<table border="1"> <tr><td>MSI1</td><td>Cove</td><td>1958</td></tr> <tr><td>MSI2</td><td>Cape</td><td>1959</td></tr> </table>	MSI1	Cove	1958	MSI2	Cape	1959		232t, 33.5x7.0x2.4m, 2d(1), 595hp, 12.5kts, 30p; 1x1-12.7/90, sweeps																																																									
MSI1	Cove	1958																																																																		
MSI2	Cape	1959																																																																		
MHC	LCI(L)	22	<table border="1"> <tr><td>MHC11</td><td>Blackbird</td><td>1943</td></tr> <tr><td>MHC16</td><td>Avocet</td><td>1944</td></tr> <tr><td>MHC17</td><td>Blue Jay</td><td>1944</td></tr> <tr><td>MHC18</td><td>Chaffinch</td><td>1944</td></tr> <tr><td>MHC19</td><td>Chewink</td><td>1944</td></tr> <tr><td>MHC20</td><td>Chimango</td><td>1944</td></tr> <tr><td>MHC21</td><td>Cockatoo</td><td>1944</td></tr> <tr><td>MHC22</td><td>Cotinga</td><td>1944</td></tr> <tr><td>MHC24</td><td>Goldcrest</td><td>1944</td></tr> <tr><td>MHC25</td><td>Jacamar</td><td>1944</td></tr> <tr><td>MHC26</td><td>Kestrel</td><td>1944</td></tr> <tr><td>MHC28</td><td>Longspur</td><td>1944</td></tr> <tr><td>MHC29</td><td>Magpie</td><td>1944</td></tr> <tr><td>MHC30</td><td>Mallard</td><td>1944</td></tr> <tr><td>MHC33</td><td>Oriole</td><td>1944</td></tr> <tr><td>MHC34</td><td>Ortolan</td><td>1944</td></tr> <tr><td>MHC37</td><td>Rail</td><td>1944</td></tr> <tr><td>MHC38</td><td>Sandpiper</td><td>1944</td></tr> <tr><td>MHC39</td><td>Sentinel</td><td>1944</td></tr> <tr><td>MHC41</td><td>Skimmer</td><td>1944</td></tr> <tr><td>MHC42</td><td>Sparrow</td><td>1944</td></tr> </table>	MHC11	Blackbird	1943	MHC16	Avocet	1944	MHC17	Blue Jay	1944	MHC18	Chaffinch	1944	MHC19	Chewink	1944	MHC20	Chimango	1944	MHC21	Cockatoo	1944	MHC22	Cotinga	1944	MHC24	Goldcrest	1944	MHC25	Jacamar	1944	MHC26	Kestrel	1944	MHC28	Longspur	1944	MHC29	Magpie	1944	MHC30	Mallard	1944	MHC33	Oriole	1944	MHC34	Ortolan	1944	MHC37	Rail	1944	MHC38	Sandpiper	1944	MHC39	Sentinel	1944	MHC41	Skimmer	1944	MHC42	Sparrow	1944		385t, 48.9x7.2x1.6m, 8d(2), 2320hp, 15.5kts, 29p; 5x1-20/70, diving equipment; SO radar, sonar
MHC11	Blackbird	1943																																																																		
MHC16	Avocet	1944																																																																		
MHC17	Blue Jay	1944																																																																		
MHC18	Chaffinch	1944																																																																		
MHC19	Chewink	1944																																																																		
MHC20	Chimango	1944																																																																		
MHC21	Cockatoo	1944																																																																		
MHC22	Cotinga	1944																																																																		
MHC24	Goldcrest	1944																																																																		
MHC25	Jacamar	1944																																																																		
MHC26	Kestrel	1944																																																																		
MHC28	Longspur	1944																																																																		
MHC29	Magpie	1944																																																																		
MHC30	Mallard	1944																																																																		
MHC33	Oriole	1944																																																																		
MHC34	Ortolan	1944																																																																		
MHC37	Rail	1944																																																																		
MHC38	Sandpiper	1944																																																																		
MHC39	Sentinel	1944																																																																		
MHC41	Skimmer	1944																																																																		
MHC42	Sparrow	1944																																																																		
	Minah	3	<table border="1"> <tr><td>MHC13</td><td>James M. Gillis</td><td>1943</td></tr> <tr><td>MHC44</td><td>Bobolink</td><td>1943</td></tr> <tr><td>MHC45</td><td>Bunting</td><td>1943</td></tr> </table>	MHC13	James M. Gillis	1943	MHC44	Bobolink	1943	MHC45	Bunting	1943		278t, 41.5x7.5x2.4m, 2d, 800hp, 14kts, 57p; 1x1-76/50, 1x1-20/70, diving equipment; SU radar, sonar																																																						
MHC13	James M. Gillis	1943																																																																		
MHC44	Bobolink	1943																																																																		
MHC45	Bunting	1943																																																																		

	Bittern	1	MHC43	Bittern	1957	A small, dark-hulled minesweeper with a single mast and various antennas.	360t, 44.1x8.5x2.4m, 2d, 1200hp, 14kts, 40p; 1x1-40/60; SPS-53 radar, sonar
MSB	MSB1	4	MSB1-4		1945	No picture	42t, 17.5x4.8x1.3m, 2d, 300hp, 12kts, 6p; sweeps
	MSL1	4	MSL1-4		1946	No picture	10t, 11.0x3.5x1.1m, 1gt, 200hp, 10kts, 4p; sweep
	MSL5	25	MSL5-29		1948	No picture	10t, 11.0x3.5x1.1m, 1gt, 200hp, 10kts, 4p; sweep
	MSL30	1	MSL30		1948	No picture	10t, 11.0x3.5x1.1m, 1gt, 200hp, 10kts, 4p; sweep
	MSB5	48	MSB5-22, 25-54		1951-1954	A small, dark-hulled minesweeper with a single mast.	42t, 17.5x4.8x1.3m, 2d, 300hp, 12kts, 6p; sweep

COMMAND SHIPS

CC	Northampton	1	CLC1	Northampton	1953	A large, grey-hulled command ship with a complex superstructure, multiple masts, and radar equipment.	17049t, 206.5x21.3x7.3m, 4b,4gst, 120000hp, 32.8kts, 1635p; 152belt, 64deck; 4x1-127/54, 4x2-76/70; SPS-2, SPS-3, SPS-6, SPS-8 radars
AGC	Appalachian	2	AGC2	Blue Ridge	1943	A large, grey-hulled command ship with a complex superstructure, multiple masts, and radar equipment.	13910t, 140.0x19.2x7.3m, 2b,1gst, 6600hp, 17kts, 875p; 2x1-127/38, 4x2-40/60, 14x1-20/70; 2LCVP, 4LCPL, 2LCPR, 2LCC, 165HQ persons; SR, SU, SK, SP radars
			AGC3	Rocky Mount	1943		
	Mount McKinley	11	AGC7	Mount McKinley	1944	A large, grey-hulled command ship with a complex superstructure, multiple masts, and radar equipment.	12560t, 139.9x19.2x7.6m, 2b,1gst, 6600hp, 17kts, 1063p; 2x1-127/38, 4x2-40/60, 14x1-20/70(AGC7-14), 12x1-20/70(AGC15-17); 2LCVP(AGC7-14), 4LCPL, 2LCC(AGC7-14), 1LCPR(AGC15-17), 336(AGC7-14)-317(AGC15-17)persons of HQ; SR, SU, SK, SP radars
			AGC8	Mount Olympus	1944		
			AGC9	Wasatch	1944		
			AGC10	Auburn	1944		
			AGC11	Eldorado	1944		
			AGC12	Estes	1944		
			AGC13	Panamint	1944		
			AGC14	Teton	1944		
			AGC15	Adirondack	1945		
			AGC16	Pocono	1945		
AGC17	Taconic	1946					
Williamsburg	1	AGC369	Williamsburg	1930	No picture	1820t, 68.3x11.0x4.9m, 2d, 2200hp, 16kts; 2x1-76/50	

AMPHIBIOUS

LPH	Essex	2	LPH4	Boxer	1945		34881t, 265.9x45.0x8.4m, 4b,4gst, 75000hp, 25kts; 102belt, 102decks; (2x2+2x1)-127/38, 40helicopters (HO4S, HRS, HUP, HUP-S, HSS, HUS, HOK, HUK, HUL, HR2S); SPS-10, SPS-12, SPS-30 radars
			LPH5	Princeton	1945		
	Casablanca	1	LPH6	Thetis Bay	1944		10886t, 156.1x32.9x6.3m, 4b,2vqe, 9000hp, 19kts, 860p; 4x2-40/60, 20helicopters(HO4S, HRS, HUP, HUP-S, HSS, HUS, HOK, HUK, HUL, HR2S); 1004troops; SG, SK radars
LSD	Ashland	8	LSD1	Ashland	1943		9375t, 139.5x22.0x4.8m, 2b,2quipe, 7400hp, 15.4kts, 254p; 1x1-127/38, (2x4+2x2)-40/60, 16x1-20/70; 3LCT(6), 332troops; SU radar
			LSD2	Belle Grove	1943		
			LSD3	Carter Hall	1943		
			LSD4	Epping Forest	1943		
			LSD5(A)	Gunston Hall	1943		
			LSD6	Lindenwald	1943		
			LSD7	Oak Hill	1944		
			LSD8	White Marsh	1944		
	Casa Grande	13	LSD13	Casa Grande	1944		9375t, 139.5x22.0x4.8m, 2b,2gst, 7000(LSD13-21,25-27)-9000(LSD22)hp, 15.4(LSD13-21,25-27)-15.6(LSD22)kts, 254p; 1x1-127/38, (2x4+2x2)-40/60, 16x1-20/70; 3LCT(6), 332troops; SU radar
			LSD14	Rushmore	1944		
			LSD15	Shadwell	1944		
			LSD16	Cabildo	1945		
			LSD17	Catamount	1945		
			LSD18	Colonial	1945		
			LSD19	Comstock	1945		
			LSD20	Donner	1945		
			LSD21	Fort Mandan	1945		
			LSD22	Fort Marion	1946		
			LSD25	San Marcos	1945		
			LSD26	Tortuga	1945		
LSD27	Wheatstone	1946					
			LSD28	Thomaston	1954		

Thomaston 8

LSD29	Plymouth Rock	1954
LSD30	Fort Snelling	1955
LSD31	Point Defiance	1955
LSD32	Spiegel Grove	1956
LSD33	Alamo	1956
LSD34	Hermitage	1956
LSD35	Monticello	1957

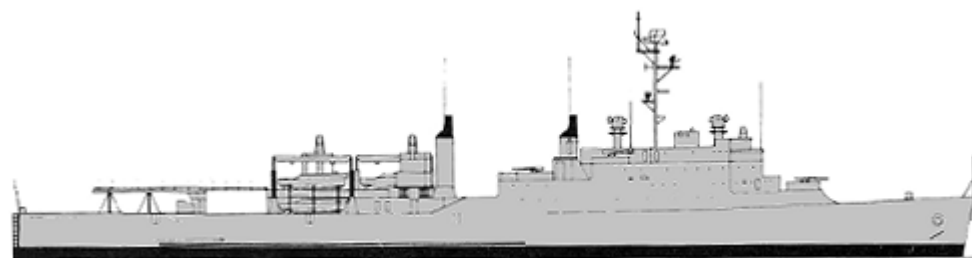

11270(LSD28-31,35)-12150(LSD32-34)t, 155.5x25.6x5.8m, 2b,2gst, 24000hp, 22.5kts, 404p; 8x2-76/50, helo deck; 3LCU, 6LCM, 341troops; SPS-6, SPS-10 radars

T-LST47		1943
T-LST117		1943
T-LST176		1943
T-LST222		1943
T-LST230		1943
T-LST276		1943
T-LST277		1943
T-LST287		1943
T-LST325		1943
LST344	Blanco County	1943
LST356	Bledsoe County	1942
LST391	Bowman County	1942
T-LST399		1943
T-LST456		1943
T-LST488		1943
T-LST491		1943
LST509	Bulloch County	1944
LST515	Caddo Parish	1944
LST519	Calhoun County	1944
LST525	Caroline County	1944
LST528	Catahoula County	1944
LST529	Cayuga County	1944
T-LST530		1944
T-LST532	Chase County	1944
LST533	Cheboygan	1944



	County	
T-LST546		1944
T-LST548		1944
T-LST550		1944
LST551	Chesterfield County	1944
T-LST566		1944
T-LST572		1944
T-LST579		1944
T-LST581		1944
LST583	Churchill County	1944
T-LST587		1944
T-LST590		1944
T-LST600		1944
LST601	Clarke County	1944
LST602	Clearwater County	1944
LST603	Coconino County	1944
T-LST607		1944
T-LST613		1944
T-LST616		1944
T-LST623		1944
T-LST626		1944
T-LST629		1944
T-LST630		1944
T-LST643		1944
T-LST649		1944
T-LST652		1944
T-LST657		1944
T-LST664		1944
LST692	Daviess County	1944
LST715	De Kalb County	1944
LST722	Dodge County	1944
LST742	Dunn County	1944
LST758	Duval County	1944
LST762	Floyd County	1944
	Garrett	

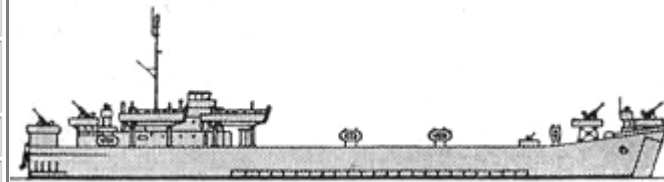

LST	LST1	114	LST786	County	1944
			LST799	Greer County	1944
			LST802	Hamilton County	1944
			LST819	Hampshire County	1944
			LST821	Harnett County	1944
			T-LST822	Harris County	1944
			LST824	Henry County	1944
			LST825	Hickman County	1944
			LST836	Holmes County	1944
			LST838	Hunterdon County	1944
			LST839	Iredell County	1944
			LST845	Jefferson County	1945
			LST846	Jennings County	1945
			LST848	Jerome County	1945
			LST854	Kemper County	1944
			LST883	La Moure County	1945
			LST887	Lawrence County	1944
			LST888	Lee County	1944
			LST898	Lincoln County	1944
			LST901	Litchfield County	1945
LST902	Luzerne County	1945			
LST905	Madera County	1945			
LST912	Mahnomen County	1944			
LST914	Mahoning County	1944			
LST938	Maricopa County	1944			
	Marion				

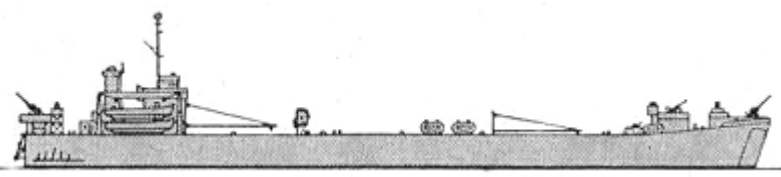

4080t, 100.0x15.2x4.3m, 2d, 1800hp, 12.1kts, 125p;
 (1x2+5x1)-40/60(LST1-541), (2x2+4x1)-40/60(LST542-1152),
 12x1-20/70; 4LCVP, 20tanks, 163troops; SU radar

T-LST975	County	1945
LST980	Meeker County	1944
LST983	Middlesex County	1944
LST987	Millard County	1944
LST1032	Monmouth County	1944
LST1041	Montgomery County	1945
LST1066	New London County	1945
LST1067	Nye County	1945
T-LST1072		1945
LST1073	Outagamie County	1945
LST1076	Page County	1945
LST1077	Park County	1945
LST1082	Pitkin County	1945
LST1083	Plumas County	1945
LST1084	Polk County	1945
LST1086	Potter County	1945
LST1088	Pulaski County	1945
LST1089	Rice County	1945
LST1090	Russell County	1945
LST1096	St. Clair County	1945
LST1101	Saline County	1945
LST1122	San Joaquin County	1945
LST1123	Sedgwick County	1945
LST1126	Snohomish County	1945
LST1134	Stark County	1945
LST1138	Steuben County	1945
LST1141	Stone County	1945
LST1144	Sublette County	1945

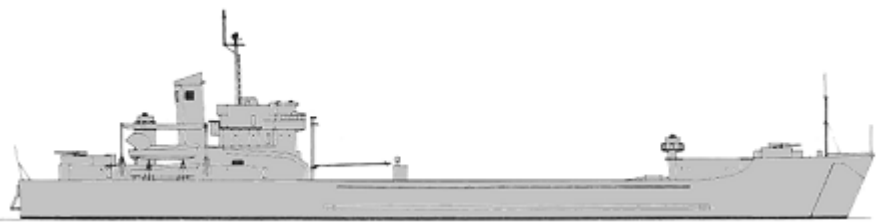
		LST1146	Summit County	1945		
		LST1148	Summer County	1945		
		LST1150	Sutter County	1945		
Talbot County	2	LST1153	Talbot County	1947		6000t, 116.4x16.5x4.4m, 2b,2gst, 6000hp, 14kts, 181p; 2x1-127/38, 2x2-40/60, 2x1-20/70; 4LCVP, 20tanks, 175troops; SU radar
		LST1154	Tallahatchie County	1949		
Terrebonne Parish	15	LST1156	Terrebonne Parish	1952		5777t, 117.1x17.1x4.9m, 4d(2), 6000hp, 15.5kts, 205p; 3x2-76/50, helodeck; 3LCVP, 1LCPL, 2000tcargo or tanks, 391troops; radars
		LST1157	Terrell County	1953		
		LST1158	Tioga County	1953		
		LST1159	Tom Green County	1953		
		LST1160	Traverse County	1953		
		LST1161	Vernon County	1953		
		LST1162	Wahkiakum County	1953		
		LST1163	Waldo County	1953		
		LST1164	Walworth County	1953		
		LST1165	Washoe County	1953		
		LST1166	Washtenaw County	1953		
		LST1167	Westchester County	1954		
		LST1168	Wexford County	1954		
		LST1169	Whitfield County	1954		
		LST1170	Windham County	1954		
De Soto County	7	LST1171	De Soto County	1958		7854t, 134.8x18.9x4.1m, 6d(2), 15000hp, 17.2kts, 185p; 3x2-76/50, helodeck; 4LCVP, 23tanks, 634troops; radar
		LST1173	Suffolk County	1957		
		LST1174	Grant County	1957		
		LST1175	York County	1957		
		LST1176	Graham	1958		

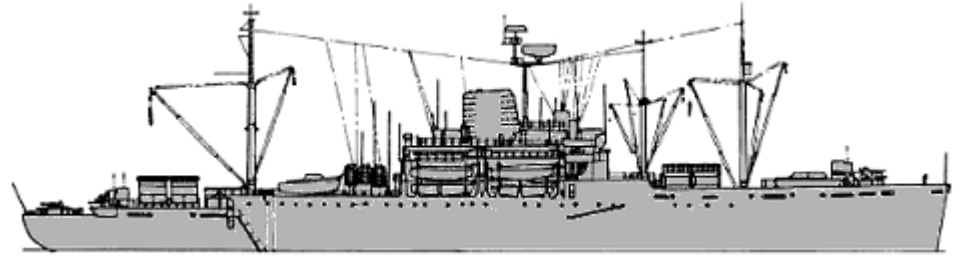
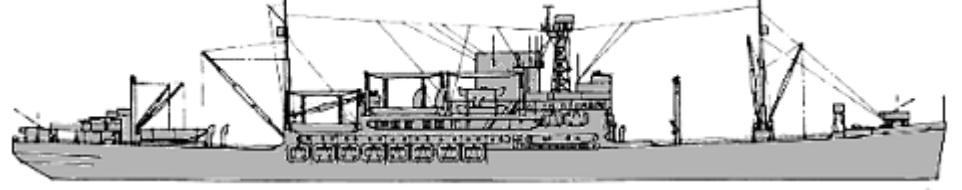
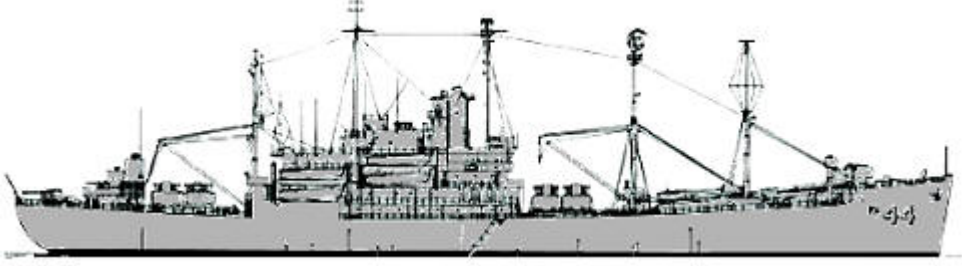
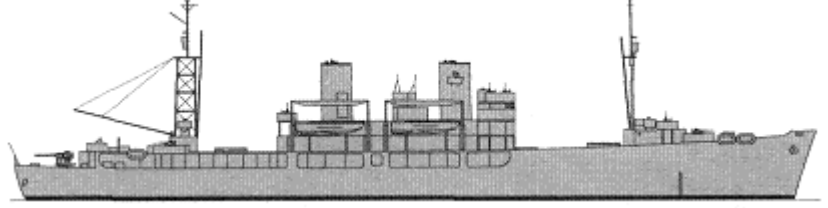
							
				County			
			LST1177	Lorain County	1958		
			LST1178	Wood County	1959		
LSM	LSM1	5	LSM161	Kodiak	1944		1095t, 62.0x10.5x2.1m, 2d, 2800hp, 13.2kts, 60p; 1x2-40/60, 4x1-20/70; 6LVT, 54troops; SU radar
			LSM175	Oceanside	1944		
			LSM373	Lakeland	1945		
			T-LSM463		1945		
			LSM540	Raritan	1945		
Arthur Middleton	1	APA27	George Clymer	1942		18000t, 149.1x21.3x8.3m, 2b,1gst, 8500hp, 16.5kts, 578p; 1x1-127/38, 4x1-76/50, 2x2-40/60, 10x1-20/70; 4LCM(6), 18LCVP, 3LCPL, 2LCPR, 2700t cargo, 1240troops; SG radar	
Crescent City	2	APA31	Monrovia	1942		14247t, 151.8x17.2x8.1m, 2b,1gst, 7800hp, 16kts, 534p; 1x1-127/38, 4x1-76/50, (1x2+1x1)-40/60, 11x2-20/70; 4LCM(6), 20LCVP, 3LCPL, 2LCPR, 2700t cargo, 1237troops; SG radar	
		APA32	Calvert	1942			
Bayfield	6	APA33	Bayfield	1943		16100t, 150.0x21.2x8.1m, 2b,1gst, 8500hp, 18kts, 575p; 2x1-127/38, 4x2-40/60, 18x1-20/70; 4LCM(6), 19LCVP, 3LCPL, 2LCPR, 4700t cargo, 1875troops; SU radar	
		APA36	Cambria	1943			
		APA37	Cavalier	1943			
		APA38	Chilton	1943			
		APA44	Fremont	1943			
		APA45	Henrico	1943			
Gilliam	1	APA67	Burleson	1944		7080t, 129.9x17.7x4.7m, 2b,2stg,2em, 6000hp, 18kts, 283p; 1x1-127/38, 4x2-40/60, 10x1-20/70; 13LCVP, 1LCPL, 1LCPR, 600t cargo, 986troops; SU radar	
		APA136	Botetourt	1945			
		APA152	Latimer	1944			
		APA156	Mellette	1944			
		APA188	Olmsted	1944			

LPA	Haskell	25	APA193	Sanborn	1944
			APA194	Sandoval	1944
			APA195	Lenawee	1944
			APA196	Logan	1944
			APA199	Magoffin	1944
			APA201	Menard	1944
			APA204	Sarasota	1944
			APA208	Talladega	1944
			APA210	Telfair	1944
			APA212	Montrose	1944
			APA213	Mountrail	1944
			APA215	Navarro	1944
			APA218	Noble	1944
			APA220	Okanogan	1944
			APA222	Pickaway	1944
			APA224	Randall	1944
			APA227	Renville	1944
			APA228	Rockbridge	1944
			APA235	Bottineau	1944
			APA237	Bexar	1945
APA239	Glynn	1945			

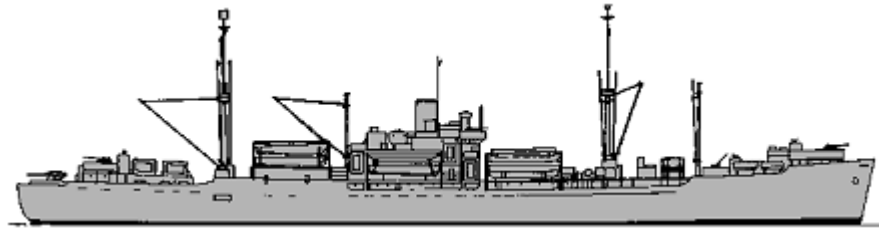

14880t, 138.7x18.9x7.3m, 2b,1gst, 8500hp, 16.5kts, 536p;
 1x1-127/38, (1x4+4x2)-40/60, 10x1-20/70; 2LCM(6),
 22LCVP, 1LCPL, 1LCPR, 1800t cargo, 1596troops; SU radar

Paul Revere	1	APA248	Paul Revere	1953
-------------	---	--------	-------------	------

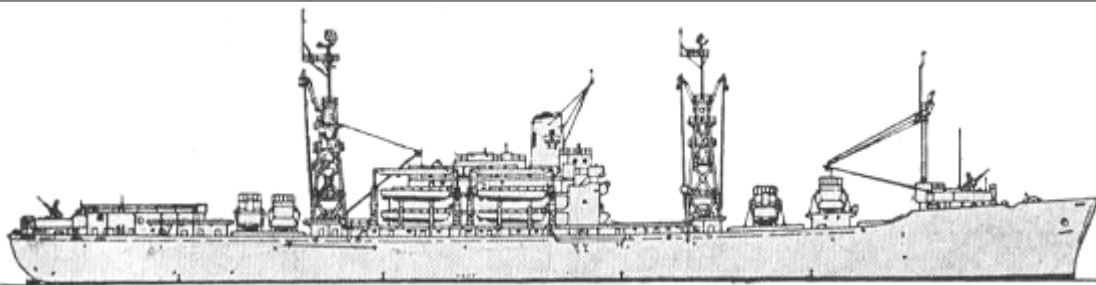

16838t, 172.0x23.2x7.9m, 2b,1gst, 22000hp, 22kts, 307p;
 4x2-76/50, helodeck; 7LCM(6), 12LCVP, 3LCP(L), 1900t of
 cargo, 1657troops; SPS-10 radar

		APD37	Charles Lawrence	1943
		APD38	Daniel T. Griffin	1943
		APD39	Barr	1944
		APD40	Bowers	1944
		APD42	Gantner	1943
		APD43	George W. Ingram	1943
		APD44	Ira Jeffery	1943
		APD45	Lee Fox	1943
		APD46	Amesbury	1943
		APD48	Blessman	1943

APD49	Joseph E. Campbell	1943
APD50	Sims	1943
APD51	Hopping	1943
APD52	Reeves	1943
APD53	Joseph C. Hubbard	1944
APD55	Laning	1943
APD56	Loy	1943
APD57	Barber	1943
APD59	Newman	1943
APD60	Liddle	1943
APD61	Kephart	1944
APD62	Cofer	1944
APD63	Lloyd	1944
APD65	Burke	1943
APD66	Enright	1943
APD69	Yokes	1944
APD70	Pavlic	1944
APD71	Odum	1945
APD72	Jack C. Robinson	1945
APD73	Bassett	1945
APD74	John P. Gray	1945
APD75	Weber	1944
APD76	Schmitt	1943
APD77	Frament	1943
APD78	Bull	1943
APD79	Bunch	1943
APD80	Hayter	1944
APD81	Tatum	1943
APD84	Haines	1943
APD85	Runels	1944
APD86	Hollis	1944
APD87	Crosley	1944
APD88	Cread	1944
APD89	Ruchamkin	1944
APD90	Kirwin	1944
APD91	Kinzer	1944
APD92	Register	1945
APD93	Brock	1945

Lawrence

APD94	John Q. Roberts	1945
APD95	William M. Hobby	1945
APD96	Ray K. Edwards	1945
APD97	Arthur L. Bristol	1945
APD98	Truxton	1945
APD99	Upham	1945
APD100	Ringness	1944
APD101	Knudson	1944
APD102	Rednour	1944
APD103	Tollberg	1945
APD104	William J. Pattison	1945
APD105	Myers	1945
APD106	Walter B. Cobb	1945
APD107	Earle B. Hall	1945
APD108	Harry L. Corl	1945
APD109	Belet	1945
APD110	Julius A. Raven	1945
APD111	Walsh	1945
APD112	Hunter Marshall	1945
APD113	Earhart	1945
APD114	Walter S. Gorka	1945
APD115	Rogers Blood	1945
APD116	Francovich	1945
APD117	Joseph M. Auman	1945
APD118	Don O. Woods	1945
APD119	Beverly W. Reid	1945
APD120	Kline	1944
APD121	Raymond W. Herndon	1944
APD122	Scribner	1944

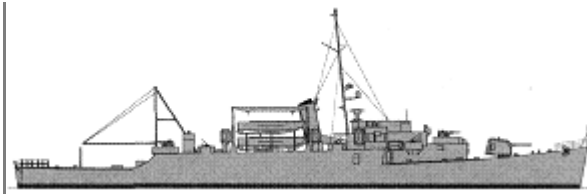

162troops; SA, SU radars, sonar

APD123	Diachenko	1944
APD124	Horace A. Bass	1944
APD126	Gosselin	1944
APD127	Begor	1945
APD129	Donald W. Wolf	1945
APD130	Cook	1945
APD131	Walter X. Young	1945
APD132	Balduck	1945
APD133	Burdo	1945
APD134	Kleinsmith	1945
APD135	Weiss	1945
APD139	Bray	1944

Procyon

5

AKA3	Bellatrix	1942
AKA4	Electra	1942
AKA12	Libra	1942
T-AKA13	Titania	1942
T-AKA14	Oberon	1942

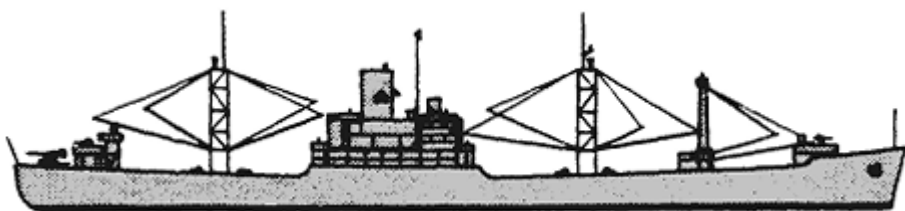

13910t, 143.0x19.2x7.8m, 1d(AKA3,4)-2b,1gst(AKA12-14), 6000hp, 16.5kts, 412p; 1x1-127/38, 4x1-76/50(AKA3,4), 4x2-40/60(AKA12-14), 18x1-20/70; 6LCM(6), 2LCM(3)(AKA3,4), 3LCM(3)(AKA12-14), 10LCVP, 1LCPL, 4515(AKA3,4)-4605(AKA12-14)t cargo, 54(AKA3,4)-190(AKA12-14)troops; SU radar

Andromeda

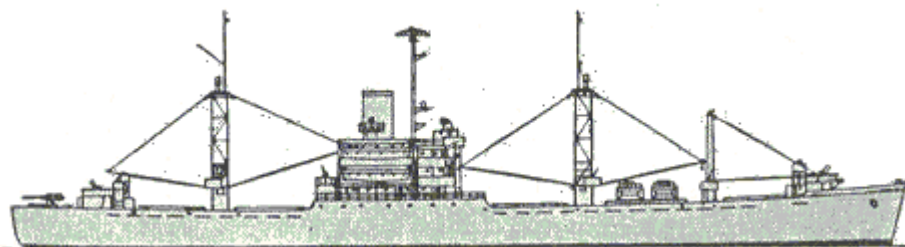

25

AKA15	Andromeda	1943
AKA19	Thuban	1943
AKA20	Virgo	1943
T-AKA53	Achernar	1944
AKA54	Algol	1943
T-AKA55	Alshain	1944
AKA56	Arneb	1943
AKA57	Capricornus	1943
T-AKA58	Chara	1944
AKA59	Diphda	1944
T-AKA60	Leo	1944
AKA61	Muliphen	1944
AKA88	Uvalde	1944
AKA89	Warrick	1944
AKA90	Whiteside	1944
AKA91	Whitley	1944
AKA92	Wyandot	1944
AKA93	Yancey	1944
AKA94	Winston	1945
AKA95	Marquette	1945
AKA96	Mathews	1945

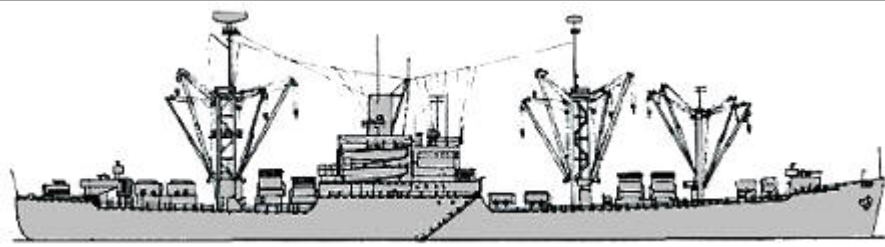
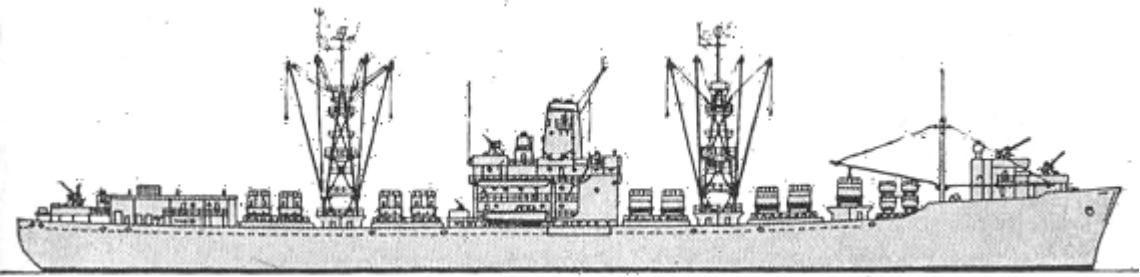

13910t, 139.9x19.2x7.9m, 2b,1gst, 6000hp, 16.5kts, 404p; 1x1-127/38, 4x2-40/60, 18x1-20/70; 6LCM(6), 2LCM(3), 13LCVP, 1LCPL, 4900t cargo, 78troops; SU radar

LKA

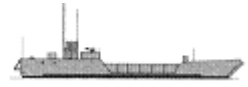
			AKA97	Merrick	1945			
			AKA98	Montague	1945			
			AKA99	Rolette	1945			
			T-AKA100	Oglethorpe	1945			
	Rankin	6	AKA103	Rankin	1945		13910t, 139.9x19.2x7.9m, 2b,1gst, 6000hp, 16.5kts, 404p; 1x1-127/38, 4x2-40/60, 16x1-20/70; 6LCM(6), 2LCM(3), 13LCVP, 1LCPL, 5275t cargo, 62troops; SU radar	
				AKA104	Seminole			1945
				AKA105	Skagit			1945
				AKA106	Union			1945
				AKA107	Vermilion			1945
				AKA108	Washburn			1945
	Tulare	1	AKA112	Tulare	1956		16800t, 172.0x23.2x7.9m, 2b,1gst, 22000hp, 22kts, 393p; 3x2-76/50, helodeck; 9LCM(6), 11LCVP, 4476t of cargo, 319troops; SPS-10 radar	
LCI(L)	LCI(L)1	2	LSIL883		1944		385t, 48.9x7.2x1.6m, 8d(2), 2320hp, 15.5kts, 29p; 5x1-20/70; 209troops; SO radar	
			LSIL966		1944			
	LCT(6)	19	LCU509		1943		320t, 36.3x10.0x1.2m, 3d, 675hp, 8kts, 13p; 2x1-20/70; 4tanks; SO radar	
				LCU637				1944
				LCU646				1944
				LCU666				1944
				LCU709				1944
				LCU716				1944
				LCU743				1944
				LCU776				1943
				LCU851				1943
				LCU917				1943
				LCU973				1944
				LCU989				1944
				LCU1126				1944
				LCU1165				1944
				LCU1203				1944
				LCU1232				1944
				LCU1273				1944
				LCU1385				1944
				LCU1388				1944
		LCU1466		1953				
		LCU1467		1953				

LCU1468		1953
LCU1469		1953
LCU1470		1953
LCU1471		1953
LCU1472		1953
LCU1473		1953
LCU1474		1953
LCU1475		1953
LCU1476		1953
LCU1477		1953
LCU1481		1953
LCU1482		1953
LCU1483		1953
LCU1484		1953
LCU1485		1953
LCU1486		1953
LCU1487		1953
LCU1488		1953
LCU1489		1953
LCU1490		1953
LCU1491		1953
LCU1492		1953
LCU1493		1953
LCU1494		1953
LCU1495		1953
LCU1496		1953
LCU1497		1953
LCU1498		1953
LCU1499		1953
LCU1500		1953
LCU1503		1953
LCU1504	Hampton Roads	1954
LCU1505		1954
LCU1506		1954
LCU1507	Chippewa	1954
LCU1508	Attu	1954
LCU1509	Antietam	1954
LCU1510	Atlanta	1954
LCU1511	Cumberland	1954
LCU1512	Cerro Gordo	1954

LCU

LCU1466 124







LCU1513		1954
LCU1514	Delaware	1954
LCU1515		1954
LCU1516	Shenandoah	1954
LCU1517		1954
LCU1518		1954
LCU1519	El Paso	1954
LCU1520		1954
LCU1521	Eniwetok	1954
LCU1522	Lorraine	1954
LCU1523		1954
LCU1524	Chapultepec	1954
LCU1525	Hollandia	1954
LCU1526	Leyte	1954
LCU1527	Guadalcanal	1954
LCU1528	Lingayen Gulf	1954
LCU1529		1954
LCU1530		1954
LCU1531		1954
LCU1532		1954
LCU1533		1954
LCU1534	Saipan	1954
LCU1535		1954
LCU1536		1954
LCU1537		1954
LCU1538		1954
LCU1539		1954
LCU1540	Pusan	1954
LCU1541		1954
LCU1542	Malolos	1954
LCU1543	Carolina	1954
LCU1544		1954
LCU1545	Meuse-Argonne	1954
LCU1546		1954
LCU1547	Solomon Islands	1954
LCU1548		1954
LCU1549	Guam	1955
LCU1550	White Wing	1955

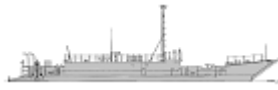

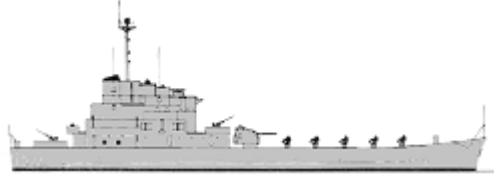
347t, 35.1x10.4x1.6m, 3d, 675hp, 8kts, 14p; 2x1-20/70, 4tanks; radar



LCU1551		1955
LCU1552		1955
LCU1553		1955
LCU1554		1955
LCU1555		1955
LCU1556	Zapople River	1955
LCU1557		1955
LCU1558		1955
LCU1559		1955
LCU1560	Rhineland	1955
LCU1561	Manila	1955
LCU1562	Inchon	1955
LCU1563		1955
LCU1564		1955
LCU1565		1955
LCU1566	Cadgell	1955
LCU1567		1954
LCU1568		1954
LCU1569		1954
LCU1570		1954
LCU1571		1954
LCU1572		1954
LCU1573		1954
LCU1574	Cold Harbor	1954
LCU1575	Junction City	1954
LCU1576		1954
LCU1577		1954
LCU1578		1954
LCU1579	Bull Run	1954
LCU1580	Veracruz	1953
LCU1581		1954
LCU1582		1954
LCU1583	Chattanooga	1954
LCU1584		1954
LCU1585		1954
LCU1586	Tunisia	1954
LCU1587	Chickamauga	1954
LCU1588		1954
LCU1589		1954
LCU1591	Viper	1954

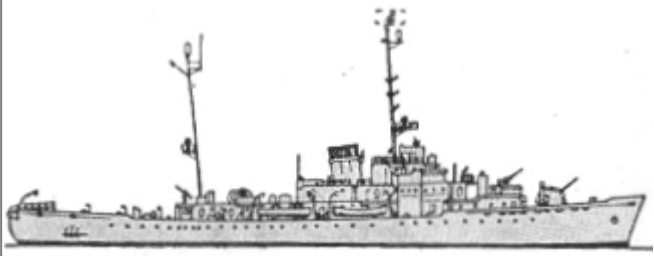

			LCU1592	Fort Reno	1954		
			LCU1593		1954		
			LCU1608		1957		
			LCU1609		1957		
	LCU1610	13	LCU1610		1957		353t, 41.3x8.9x1.8m, 2d, 1000hp, 11kts, 10p; 2x1-20/70; 4tanks; radar
			LCU1611		1957		
			LCU1612		1957		
			LCU1613		1959		
			LCU1614		1957		
			LCU1615		1957		
			LCU1616		1959		
			LCU1617		1959		
			LCU1618		1959		
			LCU1619		1959		
			LCU1620		1959		
			LCU1621		1959		
			LCU1622		1959		
			LSM(R)401	24	LSM(R)401		
	LSM(R)404	Black Warrior River			1945		
	LSM(R)405	Brooadkill River			1945		
	LSM(R)406	Canadian River			1945		
	LSM(R)409	Clarion River			1945		
	LSM(R)410	Clark Fork River			1945		
	LSM(R)411	Cumberland River			1945		
	LSM(R)412	Desplaines River			1945		
	LSM(R)504	Gila River			1945		
	LSM(R)508	Gunnison River			1945		
	LSM(R)510	James River			1945		
	LSM(R)511	John Day River			1945		
	LSM(R)512	Lamoille River			1945		
	LSM(R)513	Laramie River			1945		
	LSM(R)514	Maurice River	1945				
LFR							

			LSM(R)515	Owyhee River	1945		
			LSM(R)517	Pee Dee River	1945		
			LSM(R)520	Raccoon River	1945		
			LSM(R)522	Red River	1945		
			LSM(R)523	Republican River	1945		
			LSM(R)525	St. Francis River	1945		
			LSM(R)527	St. Joseph River	1945		
			LSM(R)531	Smoky Hill River	1945		
			LSM(R)536	White River	1945		
	Carronade	1	IFS1	Carronade	1955		1500t, 74.7x11.9x3.1m, 2d, 3100hp, 15kts, 162p; 1x1-127/38, 2x2-40/60, 8x2-127rocket launchers; SPS-10 radar
LCM	LCM(3)	200	~200		1942-1945		52t, 15.3x4.3x1.4m, 2d, 330hp, 8kts, 4p; 2x1-12.7/90; 1tank
	LCM(6)	700	~700		1943-1953		56t, 17.1x4.3x1.2m, 2d, 450hp, 9kts, 5p; 2x1-12.7/90; 1tank
	LCM(8)	700	700		1950-1955		121t, 22.4x6.4x1.5m, 2d, 1080hp, 9kts, 5p; 2x1-12.7/90, 150troops or 1 tank
LCVP	LCVP	3300	~3300		1942-1954		13t, 11.2x3.2x0.9m, 2d, 220hp, 8kts, 3p; 2x1-12.7/90; 36troops
LCPL	LCPL	300	~300		1941-1954		8t, 11.2x3.3x1.1m, 1d, 150hp, 8kts, 3p; 36troops
LCPR	LCPR	200	~200		1942-1945		8t, 11.2x3.3x1.1m, 1d, 250hp, 11kts, 3p; 36troops

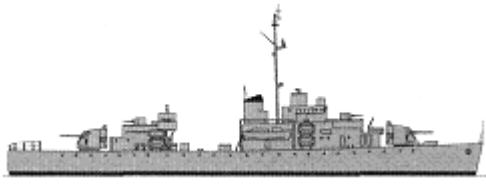
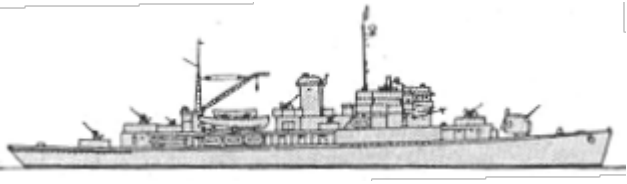
COAST GUARD

Treasury	6	WPG31	Bibb	1937		2660t, 99.7x12.5x3.8m, 2b,2gst, 5250hp, 19kts, 123p; 1x1-127/38, 1x2-40/60, 2x1-20/70(WPG31,36,37, 8x1-20/70(WPG32,33,35), 1x24-178Hedgehog, 2DCR(WPG37); radar, sonar
		WPG32	Campbell	1936		
		WPG33	Duane	1936		
		WPG35	Ingham	1936		
		WPG36	Spencer	1937		
		WPG37	Taney	1936		
		WPG39	Owasco	1945		
		WPG40	Winnebago	1945		
		WPG41	Chautauqua	1945		

PSO	Owasco	13	WPG42	Sebago	1945		2660t, 77.7x13.1x4.9m, 2b,1stg, 1em, 4000hp, 19kts, 276p; 2x2-127/38, 2x4-40/60, 4x1-20/70, 1x24-178Hedgehog, 6DCT, 2DCR; SU, Mk25 radars, sonar
			WPG43	Iroquois	1946		
			WPG44	Wachusett	1946		
			WPG64	Escanaba	1946		
			WPG65	Winona	1946		
			WPG66	Klamath	1946		
			WPG67	Minnetonka	1946		
			WPG68	Androscoggin	1946		
			WPG69	Mendota	1945		
			WPG70	Pontchartrain	1945		
PSO	Barnegat	18	WAVP370	Casco	1941		2620t, 94.7x12.5x3.8m, 4dg,2em, 6080hp, 20kts, 367p; 1x1-127/38, 1x4-40/60(WAVP374), 2x2-40/60(WAVP370-373,375-384), 1x24-178Hedgehog, 4DCT; SA, SU radars, sonar
			WAVP371	Mackinac	1942		
			WAVP372	Humboldt	1941		
			WAVP373	Matagorda	1941		
			WAVP374	Absecon	1943		
			WAVP375	Chincoteague	1943		
			WAVP376	Coos Bay	1943		
			WAVP377	Rockaway	1943		
			WAVP378	Half Moon	1943		
			WAVP379	Unimak	1943		
			WAVP380	Yakutat	1944		
			WAVP381	Barataria	1944		
			WAVP382	Bering Strait	1944		
			WAVP383	Castle Rock	1944		
			WAVP384	Cook Inlet	1944		
			WAVP385	Dexter	1941		
			WAVP386	McCulloch	1944		
			WAVP387	Gresham	1944		
PC	Active	18	WSC125	Active	1927		289t, 38.1x7.1x2.1m, 2d, 600hp, 13.3kts, 38p; 1x1-40/60, 2x1-20/70, 2x4-178Mousetrap, 2DCR; radar
			WSC126	Agassiz	1927		
			WSC127	Alert	1927		
			WSC130	Boutwell	1927		
			WSC131	Cahoone	1927		
			WSC132	Cartigan	1927		
			WSC135	Diligence	1927		
			WSC137	Ewing	1927		
			WSC139	Frederick Lee	1927		
			WSC140	General Greene	1927		
			WSC143	Kimball	1927		
			WSC144	Legare	1927		

			WSC145	Marion	1927		
			WSC146	McLane	1927		
			WSC147	Morris	1927		
			WSC153	Travis	1927		
			WSC156	Yeaton	1927		
	Argo	6	WPC101	Ariadne	1934		370t, 50.3x7.2x2.3m, 2d, 1340hp, 16kts, 50p; 2x1-76/50, 2x1-20/70, 2x4-178Mousetrap, 2DCT, 2DCR; radar
WPC103			Aurora	1931			
WPC107			Dione	1934			
WPC111			Nemesis	1934			
WPC112			Nike	1934			
WPC116			Triton	1934			
PB	95ft	35	WPB95300		1953		105t, 29.0x5.8x1.8m, 4d(2), 2200hp, 20kts, 14p; 2x1-12.7/90; radar
			WPB95301		1953		
			WPB95302		1953		
			WPB95303		1953		
			WPB95304		1953		
			WPB95305		1953		
			WPB95306		1953		
			WPB95307		1953		
			WPB95308		1953		
			WPB95309		1953		
			WPB95310		1953		
			WPB95311		1953		
			WPB95312		1955		
			WPB95313		1955		
			WPB95314		1955		
			WPB95316		1955		
			WPB95317		1955		
			WPB95318		1955		
			WPB95319		1955		
			WPB95320		1956		
WPB95321		1958					
WPB95322		1958					
WPB95323		1958					
WPB95324		1958					
WPB95325		1958					
WPB95326		1958					
WPB95327		1958					
WPB95328		1958					
WPB95329		1959					
WPB95330		1959					

		WPB95331		1959
		WPB95332		1959
		WPB95333		1959
		WPB95334		1959
		WPB95335		1959

© Ivan Gogin, 2015

[home](#)[World navies yesterday](#)[1960](#)

Uruguay 01 January 1960

PRINCIPAL SURFACE COMBATANTS

FF	Cannon 2	DE1	Uruguay	1943	A detailed black and white line drawing of the Uruguay (DE1), a large anti-aircraft cruiser. It features a complex superstructure with multiple masts, radar domes, and gun mounts. The hull number '1' is visible on the bow.	1602t, 93.3x11.2x3.2m, 4dg,2em, 6000hp, 21kts, 186p; 3x1-76/50, 1x2-40/60, 8x1-20/70, 1x3-533TT, 1x24-178 Hedgehog ASWRL, 8dct, 2dcr; SA, SF radars, sonar
		DE2	Artigas	1943		
	Castle 1	PF1	Montevideo	1944	A detailed black and white line drawing of the Montevideo (PF1), a smaller anti-aircraft cruiser. It has a simpler superstructure compared to the Uruguay, with a single main mast and a gun turret. The hull number '1' is visible on the bow.	1600t, 76.8x11.2x4.2m, 2b,1vte, 2750hp, 16.5kts, 120p; 1x1-76/50, 2x1-40/60, 4x1-20/70, 1x24-178 Hedgehog ASWRL, 4dct, 1dcr; type 276, 291 radars, sonar

PATROL AND COASTAL COMBATANTS

PC	PC 173ft	1	B1	Maldonado	1943	A detailed black and white line drawing of the Maldonado (PC), a coastal patrol ship. It has a single mast and a gun turret. The hull number '1' is visible on the bow.	330t, 52.9x7.1x2.4m, 2d, 2880hp, 21kts, 65p; 1x1-76/50, 1x1-40/60, 3x1-20/70, 2x4-178 Mousetrap ASWRL, 2dct, 2dcr; SF radar, sonar
PB	Paysandú 3	PR1	Paysandú	1936	A detailed black and white line drawing of the Paysandú (PB), a coastal patrol ship. It has a single mast and a gun turret. The hull number '3' is visible on the bow.	180t, 41.9x5.8x1.7m, 2d, 1000hp, 17kts, 51p; 2x1-76/40, 2x1-47/40	
		PR2	Salto	1936			
		PR3	Río Negro	1936			
	AVR 63ft	1	AR1		1944	No picture	34t, 19.2x4.6x1.2m, 2d, 1260hp, 33.5kts, 8p; 2x2-12.7
	PR11	1	PR11		1957	No picture	70t, 28.4x5.8x2.1m, 25kts; 1x1-20/70; radar

© Ivan Gogin, 2016

[home](#)

[World navies yesterday](#)

[1960](#)

Venezuela 01 January 1960

PRINCIPAL SURFACE COMBATANTS

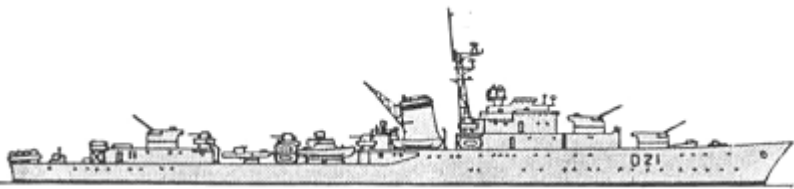
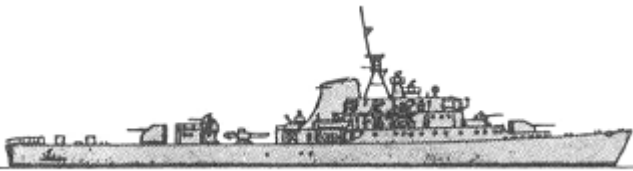
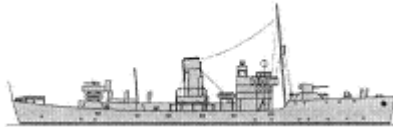
DD	Nueva Esparta	3	D11	Nueva Esparta	1953		3300t, 122.5x13.1x3.9m, 2b,2gst, 50000hp, 34.5kts, 254p; 3x2-114/45, 8x2-40/60, 1x3-533TT, 2dct, 2dcr; type 262, 274, 275, 291, 293Q radars, type 162, 170, 177 sonars
			D12	Zulia	1954		
			D13	Aragua	1956		
FF	Almirante Clemente	6	D12	Almirante Clemente	1956		1500t, 99.1x10.8x3.4m, 2b,2gst, 24000hp, 34kts, 162p; 2x2-102/45, 2x2-40/60, 4x2-20/70, 1x3-533TT, 2x24-178 Hedgehog ASWRL, 4dct, 2dcr; SPS-6, SPS-10, SPG-34 radars, SQS-4 sonar
			D13	General Flores	1956		
			D22	General Moran	1957		
			D23	Almirante Brión	1957		
			D32	General Austria	1957		
			D33	Almirante García	1957		
FS	Flower	3	1	Constitución	1941		1280t, 62.5x10.1x4.8m, 2b,1vte, 2750hp, 16.5kts, 109p; 1x1-102/45, 1x1-76/40, 2x1-20/70, 4dct, 2dcr; type 286, 290 radars, sonar
			2	Patria	1941		
			3	Victoria	1940		

PATROL AND COASTAL COMBATANTS

PB	CG 83ft	1	CS4	CS4 Felipe Santiago Esteves	1944		45t, 25.3x4.9x1.4m, 2pe, 1200hp, 20.5kts, 10p; 1x1-20/70, 2x4-178 Mousetrap ASWRL, 4dcr; SO radar, sonar
	Río Apure	8	1-8	Río Apure; Río Arauca; Río Cabriales; Río Caroni; Río Guárico; Río Negro; Río Neveri; Río Tuy	1955	No picture	38t, 24.5x4.7x1.3m, 2d, 1500hp, 27kts, 15p

AMPHIBIOUS

			T13	Los Monjes	1946		
--	--	--	-----	------------	------	--	--

LSM	LSM1	3	T14	Los Roques	1945	A detailed line drawing of a Landing Ship, Medium (LSM), showing its hull, superstructure, and various deck-mounted equipment.	1095t, 62.0x10.5x2.1m, 2d, 2800hp, 13kts, 60p; 1x2-40/60, 4x1-20/70; 5tanks, 54troops; SPS-6 radar
			T15	Los Frailes	1946		

© Ivan Gogin, 2016

[home](#)

[World navies yesterday](#)

[1960](#)

North Vietnam 01 January 1960

PATROL AND COASTAL COMBATANTS



PB	pr. 055A	6	1-6	1958		85t, 25.7x6.0x1.8m, 4d, 4800hp, 28kts, 17p; 2x2-37/63, 2x1-12.7, 2dcr; Reya radar
----	----------	---	-----	------	---	---

© Ivan Gogin, 2016



[home](#)[World navies yesterday](#)[1960](#)

South Vietnam 01 January 1960

PATROL AND COASTAL COMBATANTS

PC	PC 173ft	5	HQ01	Chi Lăng	1944		450t, 52.9x7.1x3.1m, 2d, 2880hp, 19kts, 50p; 1x1-76/50, 1x1-40/60, 4x1-20/70, 2x4 Mousetrap ASWRL 2dct, 2dcr; radar, sonar
			HQ02	Đông Đa	1943		
			HQ03	Vạn Kiếp	1943		
			HQ04	Tuy Dong	1944		
			HQ05	Tay Cây	1944		
PB	SC 110ft	2	HQ600		1943		138t, 33.8x5.2x1.9m, 2d, 1000hp, 16kts, 27p; 1x1-40/60, 3x1-20/70, 2x4 Mousetrap ASWRL, 2dct, 2dcr; radar, QC sonar
			HQ601		1942		
PBR	LCM(3)	14	1-14		1942-1944	No picture	52t, 15.3x4.3x1.4m, 2d, 330hp, 8kts, 20p; 2x1-12.7

AMPHIBIOUS

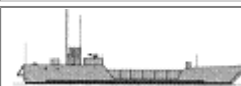
LSM	LSM1	4	HQ400	Hát Giang	1944		1095t, 62.0x10.5x2.1m, 2d, 2800hp, 13kts, 73p; 1x2-40/60, 4x1-20/70; 5tanks, 54troops; radar
			HQ401	Hàn Giang	1944		
			HQ402	Lam Giang	1944		
			HQ403	Ninh Giang	1944		
LSS	LCI(L)	5	HQ327	Long Dao	1944		385t, 48.9x7.2x1.6m, 8d(2), 14.4kts, 55p; 1x1-76/50, 1x1-40/60, 2x1-20/70, 2x1-81/12, 2x1-60/12; 209troops; radar
			HQ328	Thần Tiên	1944		
			HQ329	Thiên Kịch	1944		
			HQ330	Loi Cong	1944		
			HQ331	Tam Sat	1944		
LSS	LCU1466	5	HQ533		1953		347t, 35.1x10.4x1.6m, 3d, 675hp, 8kts, 14p; 2x1-20/70; 4tanks
			HQ534		1953		
			HQ537		1953		
			HQ538		1953		
			HQ539		1953		
LSS	LCT(6)	2	HQ535		1944		320t, 36.3x10.0x1.2m, 3d, 675hp, 8kts, 13p; 2x1-20/70; 4tanks
			HQ536		1944		
LSF	LCS(L)	4	HQ225	No Than	1945		387t, 48.2x7.2x1.7m, 8d(2), 1600hp, 14kts, 71p; 1x1-76/50, 2x2-40/60, 4x1-20/70, 4x1-12.7; radar
			HQ226	Le Trong Dam	1944		

		HQ227	Le Van Binh	1944	
		NQ228	Đoàn Ngọc Tang	1944	

MINE WARFARE

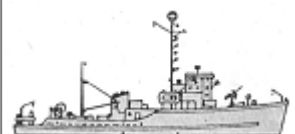
MSC	YMS	2	HQ112	Chương Dương	1942		320t, 41.5x7.5x2.4m, 2d, 800hp, 14kts, 60p; 1x1-76/50, 2x1-20/70, 2dct, 2dcr; mechanical, magnetic, acoustic minesweeping gear; SF radar
			HQ113	Bạch Đằng	1942		
	Bluebird	2	HQ114	Hàm Tử II	1959		400t, 44.3x8.1x2.1m, 2d, 1000hp, 12.5kts, 39p; 1x2-20/70, mechanical, magnetic, acoustic minesweeping gear; SPS-53 radar, UQS-1 sonar
			HQ115	Chương Dương II	1959		

© Ivan Gogin, 2016

[home](#)[World navies yesterday](#)[1960](#)

Yugoslavia 01 January 1960

SUBMARINES





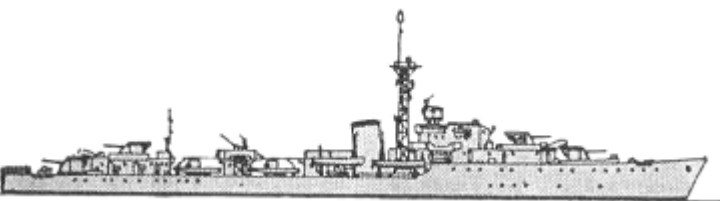
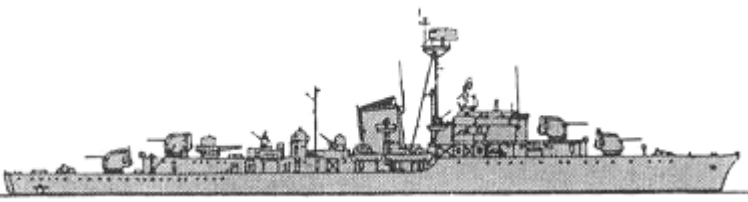
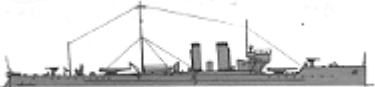
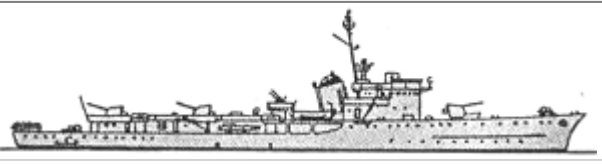
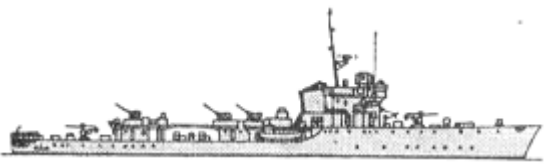



SS	Flutto	1	P802	Sava	1943		930/1093t, 63.2x7.0x4.9m, 2d/em, 2400/800hp, 16/8kts, 50p, 120m; 1x1-100/47, 6-533TT; sonar
----	--------	---	------	------	------	--	---

PRINCIPAL SURFACE COMBATANTS

DD	W	2	R21	Kotor	1943		2545t, 110.6x10.9x4.4m, 2b,2gst, 40000hp, 36.7kts, 225p; 4x1-120/45, (1x2+1x1)-40/60, 4x2-20/70, 2x4-533TT, 4dct, 2dcr; Type 275, 277, 282, 291 radars, type 123A, 127 sonars
			R22	Pula	1944		
	Split	1	R11	Split	1958		3000t, 120.0x12.0x3.7m, 3b,2gst, 50000hp, 31.5kts, 240p; 4x1-127/38, (1x4+2x2+4x1)-40/60, 1x5-533TT, 2x24-178 Hedgehog ASWRL, 6dct, 2dcr, 40mines; SC, SG-1, Mk12, Mk22 radars, sonar
FS	82F	1	T5	Tser	1915		330t, 58.8x5.8x1.5m, 2b,2gst, 5000hp, 28kts, 52p; 2x1-66/50, 2x2-450TT
	Ciclone	2	RE51	Triglav	1943		1683t, 87.8x9.9x3.8m, 2b,2gst, 16000hp, 26kts, 177p; 3x1-100/47(51), 2x1-100/47(52), (3x2+5x1)-20/70(51), (4x2+2x1)-20/70(52), 2x2-450TT, 4dct, 20mines(51); radars, sonar
			RE52	Biokovo	1943		
Ariete	2	RE53	Durmitor	1943		1110t, 83.5x8.6x3.2m, 2b,2gst, 22000hp, 31.5kts, 150p; 2x1-100/47, 3x1-40/60(54), 3x2-20/70(53), 4x1-20/65(53), 2x3-450TT(53), 2dct, 28mines(54); radars, sonar	
	RE54	Uchka	1949				

PATROL AND COASTAL COMBATANTS

--	--	--	--	--	--	--	--

MONR	Temes	1	1	Sava	1904		470t, 57.7x9.5x1.2m, 2b,2vte, 1400hp, 13kts, 89p; 40belt, 25deck, 75CT; 2x1-105/45, 3x1-40/60, 6x1-20/70
PS	Beli Orao	1	1	Jadranka	1940		660t, 65.0x8.1x2.8m, 2d, 1900hp, 18kts; 2x1-40/60
PC	PC1615	1	PBR581	Le Fougueux	1956		400t, 53.1x7.3x3.1m, 4d(2), 3240hp, 19kts, 62p; 2x1-40/60, 2x1-20/70, 1x24-178 Hedgehog ASWRL, 4dct, 2dcr; Decca radar, DUBA-2 sonar
	Mornar	1	PBR551	Mornar	1959		430t, 53.3x7.0x2.0m, 4d(2), 3240hp, 24kts, 60p; 2x1-76/50, 2x1-40/60, 2x1-20/70, 1x24-178 Hedgehog ASWRL, 2dct, 2dcr; Decca 45 radar, DUBA-2 sonar
	PBR501	8	PBR501		1954		220t, 41.0x6.3x1.7m, 2d, 3000hp, 17kts, 45p; 1x1-76/50, 1x1-40/60, 4x1-20/70, 1x24-178 Hedgehog ASWRL, 2dct, 2dcr; Decca 45 radar, QCU-2 sonar
			PBR502		1954		
			PBR503		1955		
			PBR504	Napred	1955		
			PBR505		1955		
			PBR506	Yunak	1955		
	PBR509	9	PBR507		1956		235t, 43.1x6.3x1.8m, 2d, 3300hp, 19kts, 49p; 1x1-76/50, 1x1-40/60, 4x1-20/70, 1x24-178 Hedgehog ASWRL, 2dct, 2dcr; Decca 45 radar, QCU-2 sonar
			PBR508		1956		
			PBR509		1956		
PBR510				1956			
PBR511				1956			
PBR512				1957			
PBR519			Miran	1959			
PBR520	Strelko	1959					
PBR521	Marjan	1959					
PBR522		1959					
PBR523		1959					
PT	Orjen	2	TČ391	Durmitor	1937		62t, 28.0x4.3x1.5m, 3d/1pe, 3300hp, 31kts, 16p; 1x1-40/60, 1x1-15, 2-550TT, 2dcr
			TČ392	Kajmakčalan	1938		
	TČ108	80	TČ101-186		1951-1959		60t, 23.8x6.5x2.4m, 3pe, 5000hp, 36kts, 14p; 1x1-40/60, 2x1-12.7, 2-450TT
PR	RPČ200	2	RPČ200, 201		1949	No picture	30t, 15kts; 2x1-76/50
	RPČ111	1	RPČ111		1956	No picture	29t, 26.0x4.1x0.9m, 2d, 440hp, 17.8kts, 6p; 2x1-20/90



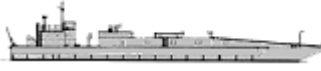

AMPHIBIOUS

MZ	2	D206	1942		239t, 47.0x6.5x1.0m, 3d, 450hp, 11kts, 13p; 1x1-76/40, 2x1-20/65; 65t of cargo or 200troops
		D219	1942		

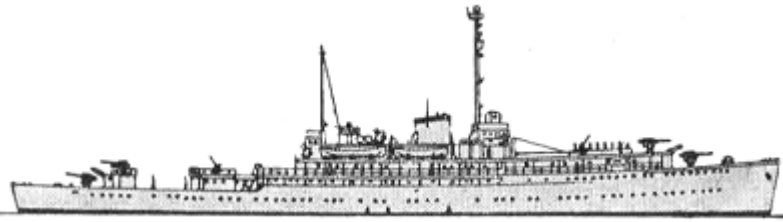
LCU	MFP-D	3	D203	1945		239t, 49.8x6.6x1.4m, 3d, 375hp, 10.3kts, 17p; 1x1-75/34, 1x1-37/83, 2x1-20/65; 140t of cargo or 200troops or 3tanks
			D204	1945		
			D205	1945		
	DTM	27	DTM211	1950		410t, 47.3x8.6x2.3m, 3d, 625hp, 10.3kts, 15p; 1x3-20/80, 100mines or 140t of cargo or 200troops
			DTM212	1950		
			DTM213	1951		
			DTM214	1951		
			DTM215	1951		
			DTM216	1952		
			DTM217	1952		
			DTM218	1952		
			DTM219	1953		
			DTM220	1953		
			DTM221	1953		
			DTM222	1954		
			DTM223	1954		
			DTM224	1954		
			DTM225	1955		
			DTM226	1955		
			DTM227	1955		
			DTM228	1956		
			DTM229	1956		
			DTM230	1956		
			DTM231	1957		
			DTM232	1957		
			DTM233	1957		
			DTM234	1958		
			DTM235	1958		
			DTM236	1958		
			DTM237	1959		
	LC	catamaran	10	1-10	1951-1959	No picture

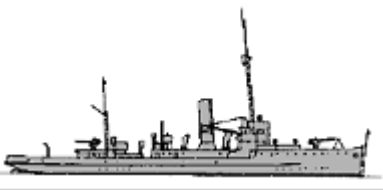
MINE WARFARE

ML	Ramb	1	M11	Galeb	1939		5700t, 121.2x15.2x5.6m, 2d, 7200hp, 16kts; 4x1-88/45, 4x1-40/60, 6x4-20/65, mines; radar

MSO	M1916	1	1	Zelengora	1918		590t, 59.6x7.3x2.2m, 2b,2vte, 1840hp, 16kts, 51p; 2x1-83/52, 24mines, minesweeping gear
MSC	Mercure	3	M151	Hrabri	1957		440t, 46.4x8.6x2.5m, 2d, 2000hp, 15kts, 40p; 1x2-20/70, mechanical, acoustic, magnetic minesweeping gear; DRBN-30 radar, type 193M sonar
			M152	Smeli	1957		
			M153	Slobodni	1957		
MSI	MT131	3	M31	Meljine	1931		115-128t, 30.1x6.7x1.7m, 1b,2vte, 280hp, 11.6kts, 27p; 1x1-47/44, 34mines or minesweeping gear
			M32	Marjan	1931		
			M33	Mljet	1931		
	RD	7	ML301		1917		196-201m, 35.3-36.5x5.8x2.0-2.1m, 1b,1vte, 800-970hp, 10-11kts, 22p; 1x1-76/40, minesweeping gear
			ML302		1917		
			ML303		1918		
			ML304		1918		
			ML305		1918		
			ML306		1918		
	M101	18	M101-116, 120, 140		1950-1956		95t, 25.0x5.9x1.9m, 1d, 135-175hp, 12kts; 1x1-40/60, 1x1-20/70, minesweeping gear
MSR	M301	24	M301-324		1951-1953	No picture	38t, 14.0x xm, 2d, 1000hp, 12kts; 1x2-20/80, minesweeping gear; Decca radar